

**NORTH ATLANTIC TREATY ORGANIZATION**



**RESEARCH AND TECHNOLOGY ORGANIZATION**

BP 25, 7 RUE ANCELLE, F-92201 NEUILLY-SUR-SEINE CEDEX, FRANCE

**RTO LECTURE SERIES 221 bis**

# **Technologies for Future Precision Strike Missile Systems**

(les Technologies des futurs systèmes de missiles pour  
frappe de précision)

*The material in this publication was assembled to support a Lecture Series under the sponsorship of the Systems Concepts and Integration Panel (SCI) and the Consultant and Exchange Programme of RTO presented on 18-19 June 2001 in Tbilisi, Georgia, on 21-22 June 2001 in Bucharest, Romania, on 25-26 June 2001 in Madrid, Spain, and on 28-29 June 2001 in Stockholm, Sweden.*

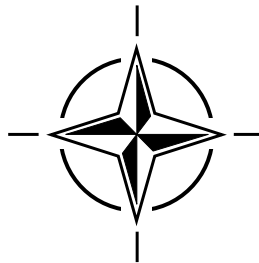

**This page has been deliberately left blank**



**Page intentionnellement blanche**

**NORTH ATLANTIC TREATY ORGANIZATION**

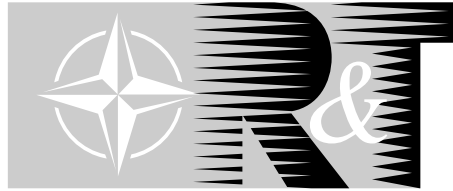

**RESEARCH AND TECHNOLOGY ORGANIZATION**

BP 25, 7 RUE ANCELLE, F-92201 NEUILLY-SUR-SEINE CEDEX, FRANCE

---

**RTO LECTURE SERIES 221 bis**

## **Technologies for Future Precision Strike Missile Systems**

(les Technologies des futurs systèmes de missiles pour frappe de précision)

*The material in this publication was assembled to support a Lecture Series under the sponsorship of the Systems Concepts and Integration Panel (SCI) and the Consultant and Exchange Programme of RTO presented on 18-19 June 2001 in Tbilisi, Georgia, on 21-22 June 2001 in Bucharest, Romania, on 25-26 June 2001 in Madrid, Spain, and on 28-29 June 2001 in Stockholm, Sweden.*



# The Research and Technology Organization (RTO) of NATO

RTO is the single focus in NATO for Defence Research and Technology activities. Its mission is to conduct and promote cooperative research and information exchange. The objective is to support the development and effective use of national defence research and technology and to meet the military needs of the Alliance, to maintain a technological lead, and to provide advice to NATO and national decision makers. The RTO performs its mission with the support of an extensive network of national experts. It also ensures effective coordination with other NATO bodies involved in R&T activities.

RTO reports both to the Military Committee of NATO and to the Conference of National Armament Directors. It comprises a Research and Technology Board (RTB) as the highest level of national representation and the Research and Technology Agency (RTA), a dedicated staff with its headquarters in Neuilly, near Paris, France. In order to facilitate contacts with the military users and other NATO activities, a small part of the RTA staff is located in NATO Headquarters in Brussels. The Brussels staff also coordinates RTO's cooperation with nations in Middle and Eastern Europe, to which RTO attaches particular importance especially as working together in the field of research is one of the more promising areas of initial cooperation.

The total spectrum of R&T activities is covered by the following 7 bodies:

- AVT Applied Vehicle Technology Panel
- HFM Human Factors and Medicine Panel
- IST Information Systems Technology Panel
- NMSG NATO Modelling and Simulation Group
- SAS Studies, Analysis and Simulation Panel
- SCI Systems Concepts and Integration Panel
- SET Sensors and Electronics Technology Panel

These bodies are made up of national representatives as well as generally recognised 'world class' scientists. They also provide a communication link to military users and other NATO bodies. RTO's scientific and technological work is carried out by Technical Teams, created for specific activities and with a specific duration. Such Technical Teams can organise workshops, symposia, field trials, lecture series and training courses. An important function of these Technical Teams is to ensure the continuity of the expert networks.

RTO builds upon earlier cooperation in defence research and technology as set-up under the Advisory Group for Aerospace Research and Development (AGARD) and the Defence Research Group (DRG). AGARD and the DRG share common roots in that they were both established at the initiative of Dr Theodore von Kármán, a leading aerospace scientist, who early on recognised the importance of scientific support for the Allied Armed Forces. RTO is capitalising on these common roots in order to provide the Alliance and the NATO nations with a strong scientific and technological basis that will guarantee a solid base for the future.

The content of this publication has been reproduced directly from material supplied by RTO or the authors.

Published July 2001

Copyright © RTO/NATO 2001  
All Rights Reserved

ISBN 92-837-1070-3



*Printed by St. Joseph Ottawa/Hull  
(A St. Joseph Corporation Company)  
45 Sacré-Cœur Blvd., Hull (Québec), Canada J8X 1C6*

# Technologies for Future Precision Strike Missile Systems

(RTO EN-018 / SCI-087 bis)

## Executive Summary

This report documents the results of NATO Research and Technology Organization (RTO) lecture series number 221, entitled “Technologies for Future Precision Strike Missile Systems.” The primary purpose of the lecture series was the disseminating of state-of-the-art scientific and technical knowledge among a wide audience. The lecture series identified significant developments in the enabling technologies and provided examples of the advancements. It also addressed the challenging requirements in areas such as adverse weather capability, time critical targets, high kill probability, no collateral damage, high survivability light-weight expeditionary warfare weapons, and affordability.

Emerging technologies for precision strike missile systems that were addressed in the lecture series included:

**Mission planning technology.** Assessments included off-board sensor integration, near-real-time mission planning, flight altitude, terrain following, and missile data links for in-flight targeting.

**Missile aeromechanics technology.** Assessments included hypersonic airframes, low cost/high temperature structure, and ramjet propulsion.

**Guidance & control technology.** An overview of existing guidance and control was given. Assessments included precision guidance and optimal guidance laws.

**Missile GPS/INS sensor technology.** Assessments included low cost INS and GPS/INS integration.

**Missile design technology.** An overview of the missile design process was given. Assessments included computer programs and electronic spreadsheets for conceptual design and missile design criteria.

**Seeker technology.** Assessments included active and passive imaging infrared and radar seekers.

**Missile/aircraft integration technology.** Assessments included high firepower weapon concepts, reduced observables, and insensitive munitions.

**Simulation/validation technology.** Assessments included hardware-in-the-loop and design validation.

**Automatic target recognition technology.** Assessments included robust algorithms and hardware/algorithm optimization.

The material in this publication was assembled to support a Lecture Series under the sponsorship of the Systems Concepts and Integration (SCI) Panel and the Consultant and Exchange programme of RTO. The lectures were first held March 23-24, 2000 in Atlanta Georgia USA, at the Georgia Institute of Technology. Following the lectures at Georgia Tech, the lectures were held April 3-4, 2000 in Turin, Italy and April 6-7, 2000 in Ankara, Turkey. Due to the interest in the lectures, they were reprised in 2001. Updated lectures were presented in Tbilisi, Georgia (18-19 June 2001), Bucharest, Romania (21-22 June 2001), Madrid, Spain (25-26 June 2001), and Stockholm, Sweden (28-29 June 2001).

# les Technologies des futurs systèmes de missiles pour frappe de précision

(RTO EN-018 / SCI-087 bis)

## Synthèse

Ce rapport présente les résultats du Cycle de conférences No. 221 sur «les technologies des futurs systèmes de missiles de frappe de précision» organisé par l'Organisation pour la recherche et la technologie de l'OTAN (RTO). Ce cycle de conférences a eu pour objectif principal la diffusion, auprès d'un large public, de l'état des connaissances scientifiques et techniques dans ce domaine. Le cycle de conférences a permis d'identifier des développements significatifs dans le domaine des technologies habilitantes et a fourni des exemples de ces avancées. Il a également permis d'examiner les besoins les plus contraignants dans les domaines suivants : capacité tous temps, cibles à fenêtre de frappe restreinte, probabilité de destruction élevée, absence de dommages collatéraux, armes légères à haute capacité de survie pour corps expéditionnaires, et coûts abordables.

Les technologies naissantes suivantes, relatives aux systèmes de missiles de frappe de précision, ont été abordées durant le Cycle de conférences :

**Les technologies de planification de mission**, avec une évaluation de l'intégration des senseurs non embarqués, de la planification des missions en temps quasi-réel et des liaisons de données missiles pour la désignation des objectifs en vol.

**Les technologies concernant l'aéromécanique des missiles**, avec une évaluation des cellules hypersoniques, des structures à coût modéré résistant aux hautes températures, et de la propulsion par statoréacteur.

**Les technologies de guidage et de pilotage**. Un tour d'horizon des technologies existantes dans ce domaine a été présenté, avec une évaluation des lois de guidage de précision et de guidage optimal.

**Les technologies des capteurs GPS/INS** avec une évaluation de l'intégration à coût modéré du matériel INS et GPS/INS.

**Les technologies de conception des missiles** Un tour d'horizon du processus de conception des missiles a été présenté, avec une évaluation des programmes informatiques et des tableurs pour les études de définition, ainsi que des critères de conception des missiles.

**Les technologies des autodirecteurs avec une évaluation des autodirecteurs actifs et passifs à ondes millimétriques et infrarouges.**

**Les technologies d'intégration missile/aéronef**, avec une évaluation des concepts d'armements à grande puissance de feu, de la furtivité et des munitions à risques atténués.

**Les technologies de simulation/validation** avec une évaluation du matériel dans la boucle et de la validation de la conception.

**Les technologies de reconnaissance automatique de la cible**, avec une évaluation des algorithmes robustes et de l'optimisation du matériel par rapport aux algorithmes.

Les textes présentés dans cette publication ont servi de support à un cycle de conférences organisé sous l'égide de la commission sur les concepts et l'intégration de systèmes (SCI) dans le cadre du programme de consultants et d'échanges de la RTO. Les premières conférences ont été présentées les 23 et 24 mars 2000 à l'Institut de Technologie de Géorgie à Atlanta, Géorgie, Etats-Unis. Les mêmes conférences ont également été présentées les 3 et 4 avril à Turin, en Italie et les 6 et 7 avril à Ankara, en Turquie. En raison de l'intérêt manifesté pour ce cycle de conférences, il a été repris en 2001. Des conférences mises à jour ont été présentées à Tbilisi en Géorgie (les 18 et 19 juin 2001), à Bucarest en Roumanie (les 21 et 22 juin 2001), à Madrid en Espagne (les 25 et 26 juin 2001), et à Stockholm en Suède (les 28 et 29 juin 2001).

# Contents

	<b>Page</b>
<b>Executive Summary</b>	<b>iii</b>
<b>Synthèse</b>	<b>iv</b>
<b>List of Authors/Speakers</b>	<b>vi</b>
	<b>Reference</b>
<b>Introduction/Overview</b> by E.L. Fleeman	<b>I</b>
<b>Mission Planning Technology</b> by E. Berglund	<b>1</b>
<b>Missile Aeromechanics Technology</b> by E.L. Fleeman	<b>2</b>
<b>Guidance and Control Technology</b> by E. Berglund	<b>3</b>
<b>INS/GPS for Strike Warfare Beyond the Year 2000</b> by W.H. Licata	<b>4</b>
<b>Missile Design Technology</b> by E.L. Fleeman	<b>5</b>
<b>Missile Seekers for Strike Warfare Beyond the Year 2000</b> by W.H. Licata	<b>6</b>
<b>Missile/Aircraft Integration</b> by E.L. Fleeman	<b>7</b>
<b>Simulation/Design Validation Technology</b> by E. Berglund	<b>8</b>
<b>Automatic Target Recognition (ATR) Beyond the Year 2000</b> by W.H. Licata	<b>9</b>

# List of Authors/Speakers

**Lecture Series Director:** Mr Eugene FLEEMAN  
Aerospace Systems Design Laboratory  
School of Aerospace Engineering  
Georgia Institute of Technology  
Atlanta, Georgia 30332-0150  
UNITED STATES

## AUTHORS/LECTURERS

Mr Erik BERGLUND  
Swedish Defence Research Agency  
172 90 Stockholm  
SWEDEN

Mr William LICATA  
Raytheon Corporation  
Senior Principal Systems Engineer  
3590 New Heritage Drive  
Alpharetta, Ga 30022  
UNITED STATES



# Technologies for Future Precision Strike Missile Systems - Introduction/Overview

**Eugene L. Fleeman**

Aerospace Systems Design Laboratory  
School of Aerospace Engineering  
Georgia Institute of Technology  
Atlanta, Georgia 30332-0150, United States  
Eugene.Fleeman@asdl.gatech.edu

## Abstract/Executive Summary

This report documents and updates the results of NATO Research and Technology Organization (RTO) lecture series number 221, entitled “Technologies for Future Precision Strike Missile Systems.” The lecture series was conducted under the RTO Consultant and Exchange (C&E) Program as a two-day educational event. The lectures were first held March 23-24, 2000 in Atlanta Georgia USA, at the Georgia Institute of Technology. Following the lectures at Georgia Tech, the lectures were held April 3-4, 2000 in Turin, Italy and April 6-7, 2000 in Ankara, Turkey. Due to the interest in the lectures, they were reprised in 2001. Updated lectures were presented in Tbilisi, Georgia (18-19 June 2001), Bucharest, Romania (21-22 June 2001), Madrid, Spain (25-26 June 2001), and Stockholm, Sweden (28-29 June 2001).

The primary purpose of the lecture series was the disseminating of state-of-the-art scientific and technical knowledge among a wide audience. The lecture series identified significant developments in the enabling technologies and provided examples of the advancements. It also addressed the challenging requirements in areas such as adverse weather capability, time critical targets, high kill probability, no collateral damage, high survivability light-weight expeditionary warfare weapons, and affordability.

Emerging technologies for precision strike missile systems that were addressed in the lecture series included: **Mission planning technology.** Assessments included off-board sensor integration, near-real-time mission planning, flight altitude, terrain following, and missile data links for in-flight targeting.

**Missile aeromechanics technology.** Assessments included hypersonic airframes, low cost/high temperature structure, and ramjet propulsion.

**Guidance & control technology.** An overview of existing guidance and control was given. Assessments included precision guidance and optimal guidance laws.

**Missile GPS/INS sensor technology.** Assessments included low cost inertial navigation system (INS) and Global Positioning System (GPS)/INS integration.

**Missile design technology.** An overview of the missile design process was given. Assessments included computer programs and electronic spreadsheets for conceptual design and missile design criteria.

**Seeker technology.** Assessments included active and passive imaging infrared and radar seekers.

**Missile/aircraft integration technology.** Assessments included high firepower weapon concepts, reduced observables, and insensitive munitions.

**Simulation/validation technology.** Assessments included hardware-in-the-loop and design validation.

**Automatic target recognition technology.** Assessments included robust algorithms and hardware/algorithm optimization.

## Introduction

The last decade has seen increased usage of precision strike missile systems for military strike operations. Moreover, precision strike missiles are expected to have an even larger share of military strike operations in the future. A key contributor to the increased effectiveness of precision strike missiles is the advancement in technology. Examples of system effectiveness improvements include improved missile range, firepower,

maneuverability, accuracy, lethality, and adverse weather capability. This lecture series provided insight into the enabling technologies and the state-of-the-art for precision strike missile systems.

A historical example of the value of guided weapons is the Thanh Hoa Bridge in Vietnam. For over six years, a total of 871 aircraft sorties dropped unguided bombs but failed to close the bridge. However, the first operational application of laser-guided bombs on 13 May 1972 resulted in direct hits on the supporting piers, dropping the center span and closing the bridge. It is noted that eleven aircraft were lost using unguided munitions in the 871 previous sorties. No aircraft were lost in the four sorties using precision guided munitions.

The technical program for the lectures consisted of two days. The first day included registration, opening ceremony, an introduction/overview, and lectures on mission planning technology, missile aeromechanics technology, guidance & control technology, missile GPS/INS technology, and missile design technology. Day 2 continued the program with lectures on seeker technology, missile/aircraft integration, simulation/validation, and automatic target recognition technologies. Following the lectures, there was a round-table discussion to address questions and comments from the attendees. The lecture series director provided concluding remarks.

The lecture series director was Mr. Eugene Fleeman of the Georgia Institute of Technology. Other speakers were Mr. Erik Berglund of the Swedish Defence Research Agency, and Mr. William Licata of the Raytheon Company.

Figure 1 summarizes the focus of this lecture series. Primary areas of emphasis were technologies in aerodynamics, propulsion, structures/materials, guidance and control, seeker, missile design, GPS/INS sensors, missile/aircraft integration, simulation/validation, automatic target recognition (ATR), and mission management. Other areas that were addressed, but with lesser emphasis, included missile data link, cost/logistics, reduced observables, and survivability.

This lecture series recognizes that precision strike missiles are different from other flight vehicles, such as combat aircraft. Precision strike missiles are a technical specialty in their own right. For example, Figure 2 compares precision strike missile characteristics and the current state-of-the-art (SOTA) with that of fighter aircraft. Examples are shown where missiles are driving technology. Also shown are other areas where the missile is not driving technology in comparison with fighter aircraft.

As an example, the lateral and longitudinal acceleration SOTA of missiles exceeds that of combat aircraft. Missile lateral maneuverability of 30+ g's and longitudinal acceleration of 30+ g's have been demonstrated. Notable examples of precision strike missiles with high acceleration and maneuverability include AGM-88 HARM and AGM-114 Hellfire missiles. Missile speed is also usually greater than that of combat aircraft, an example is the AS-17/Kh 31 hypersonic ramjet missile. Another difference is dynamic pressure loading on a missile, which is usually greater than of combat aircraft. An example of a precision strike missile that operates at high dynamic pressure is the ANS ramjet missile. Another difference is the relatively small size and lighter weight of missiles in comparison to combat aircraft, notably the LOCAAS powered submunition. Related to cost, missiles are a throw-away. As a result, they are more cost-driven than combat aircraft. Development cost is smaller for missiles and the difference in production cost is even more dramatic. An example is the GBU-31 JDAM, with cost on the order of \$15,000, compared to 10's of millions of dollars for typical combat aircraft. Finally, cruise missiles such as AGM-129 are able to achieve low radar cross section without the other design limitations associated with piloted aircraft.

Areas where the combat aircraft have superior capability include range, targets killed per use, and target acquisition. Although the conventional version of the AGM 86 cruise missile (CALCM) has a flight range that can exceed 700 nautical miles, combat aircraft have much longer range. In the area of target kill capability, precision strike missiles have become more efficient in recent years, with a single target kill probability approaching one and a capability for multiple target kills. The Apache missile is an example of an efficient precision strike missile. It has high accuracy and is capable of dispensing submunitions, exhibiting high firepower. However the same missiles are load-outs on combat aircraft, and so the enhancement in

missiles also enhances the combat aircraft effectiveness and firepower. Finally, although smart, powered submunitions such as LOCAAS have demonstrated a capability for automatic target recognition (ATR), combat aircraft with a human pilot continues to have superior capability for target recognition, discrimination and acquisition. Autonomous target acquisition by missiles is a relatively immature technology that will improve in the future with new technologies such as multi-mode and multi-spectral seekers.

## Examples of Precision Strike Missiles

Figure 3 is an example of surface target types and the characteristics of current precision strike missiles. The missions for precision strike missiles cover a broad range of targets, including fixed targets, radar sites, ships, armor, and buried targets.

In the case of **fixed targets** (which usually are of large size with hardness ranging from soft to hard), a blast fragmentation warhead or dispensed cluster submunitions are usually used. The current missiles for use against fixed targets are relatively large, with wings for efficient subsonic flight. Current missiles in this category include AGM-154 JSOW, Apache, KEPD-350, BGM-109 Tomahawk, and AGM-142 Have Nap.

The second target category is **radar sites**. Radar sites are relatively soft, and a blast fragmentation warhead is usually used. Anti-radar missiles have an anti-radiation homing (ARH) seeker and generally fly at high supersonic Mach number, for launch aircraft survivability in a SAM engagement and to minimize threat radar shutdown before missile impact. Current missiles in this category include AGM-88 HARM, AS-11 Kilter/Kh-58, ARMAT, AS-12 Kegler/Kh-27, and ALARM.

A third target category is **ship targets**. Ships are relatively hard targets and usually require a kinetic energy penetrating warhead, followed by blast fragmentation after penetration of the hull. Anti-ship missiles are generally large size and have a large warhead. Anti-ship missiles are designed to survive ship defenses, relying on either speed or flying at low altitude in clutter to survive. Current anti-ship missiles include MM40 Exocet, AS-34 Kormoran, AS-17 Krypton/Kh-34, Sea Eagle, and SS-N-22 Sunburn/3M80.

A fourth category is **armor targets**. This includes tanks, armored personnel carriers, and other armored combat vehicles. Armor targets are small size, mobile, and very hard. Typical anti-armor warheads include shaped charge, explosively formed projectile (EFP), and kinetic energy penetrator. Most anti-armor missiles are small size, have hit-to-kill accuracy, and are low cost. Examples are Hellfire/Brimstone, LOCAAS, MGM-140 ATACMS with submunitions, AGM-65 Maverick, and LOSAT.

A final category is **buried targets**. Buried targets require a high fineness kinetic energy penetration warhead, followed by blast fragmentation. Buried targets include underground command posts and bunkers. The current missiles in this category (CALCM, GBU-28, GBU-31 JDAM) are large and heavy. A technical concern is flight control at impact to avoid breaking up the warhead. Design considerations include the shape of the nose, weight, case material, and diameter. Explosives and fuzes must survive at high deceleration.

## Alternatives for Precision Strike

Figure 4 is an example of alternative approaches that should be considered in establishing mission requirements. It illustrates an assessment of alternative approaches for precision strike. The assessment includes the approaches that are used today by current systems, as well as a projection of capabilities that may be used in the future for new missile systems. Three measures of merit are assumed in comparing future precision strike missiles with the current systems. These are cost per shot, number of launch platforms required, and the effectiveness against time critical targets. For the current systems, two approaches are used: 1) penetrating aircraft with relatively short range subsonic precision guided munitions or missiles and 2) standoff platforms (e.g., ships, aircraft) using subsonic cruise missiles. The penetrating aircraft systems include the F-117 with subsonic precision guided munitions such as JDAM. As shown, penetrating aircraft/subsonic precision guided munitions have an advantage of low cost per shot, about \$15,000. However, the experience in Desert Storm showed that subsonic penetrating aircraft do not have the capability to counter time critical targets such as theater ballistic missiles (TBMs). Another current approach, using

standoff platforms such as ships and large aircraft outside the threat borders requires fewer launch platforms, resulting in lower logistics costs. However, standoff platforms with subsonic cruise missiles (e.g., Tomahawk, CALCM) are also ineffective against time critical targets (TCTs) such as theater ballistic missiles.

Also shown in the figure are future missile system alternatives. Technology development work is under way in all three areas; the best approach has yet to be demonstrated. One approach is based on a standoff platform, with an aircraft, ship, or submarine standing off outside the threat country border. Hypersonic long-range precision strike missiles would provide broad coverage, holding a large portion of the threat country at risk. This approach is attractive in the small number of launch platforms required and the effectiveness against TCTs. Based on current technology programs such as the Affordable Rapid Response Missile Demonstrator (ARRMD) Program, the cost of future hypersonic missiles is projected to be comparable to that of current cruise missiles.

Another alternative approach is to use overhead, loitering unmanned combat air vehicles (UCAVs) with hypersonic missiles. The number of UCAVs required is dependent upon the speed and range of their on-board missiles. This approach would probably provide the fastest response time against time critical targets, because of the shorter required flight range of the missile.

A third approach is overhead loitering UCAVs with light weight precision guided munitions. This approach would have the lowest cost per shot, but would also require a larger number of UCAVs.

An enabling synergistic capability for precision strike is the application of near-real-time, accurate targeting from either overhead tactical satellite or overhead unmanned air vehicle (UAV) sensors. It is projected that an advanced command, control, communication, computers, intelligence, surveillance, reconnaissance (C4ISR) network will be available in the year 2010 time frame to support near-real-time and high accuracy targeting of time critical targets. The C4ISR network could be used by all types of launch platforms (e.g., fighter aircraft, bombers, helicopters, UCAVs, ships, submarines, ground vehicles). Illustrated in Figure 5 are examples of a ground station, overhead satellite sensors and satellite relays, and the overhead UAV sensor platform elements of the assumed C4ISR architecture. The assumed C4ISR of the year 2010 is projected to have a capability for a target location error (TLE) of less than 1 meter (1 sigma) and sensor-to-shooter connectivity time of less than 2 minutes (1 sigma). A data link from the launch platform to the missile will allow in-flight target updates and battle damage indication/battle damage assessment (BDI/BDA). An enabling technology for a light weight/low volume missile data link is phased array antenna. A phased array antenna can be conformally mounted on the missile airframe.

The improved responsiveness of hypersonic precision strike missiles must be harmonized with other measures of merit such as robustness, warhead lethality, miss distance, observables, survivability, reliability, and cost, as well as constraints such as launch platform integration and firepower requirements (Figure 6).

## **Missile Design Validation and Technology Development Process**

Missile technology development is focused on the key enabling technologies that are driven by the requirements, but are in need of additional development and demonstration for a required level of maturity. The technology development program addresses alternative approaches and risk mitigation. It has exit criteria for each phase, and an exit plan in the event of failure. The technology development and demonstration activities lead to a level of readiness for entry into Engineering and Manufacturing Development (EMD).

Early technology work addresses laboratory tests and demonstrations of a critical component of a subsystem in a representative environment, but not necessarily a full-scale environment. The next step of technology development is a laboratory or a flight demonstration of a subsystem in a representative, but not a full-scale environment. This is followed by either a laboratory demonstration or a flight Advanced Technology Demonstration (ATD) of a subsystem in a full-scale environment. Finally, there is a flight demonstration, based on either an Advanced Concept Technology Demonstration (ACTD) or a Program Definition and Risk Reduction (PDRR) of a full-scale prototype missile in a full-scale environment. This is required for a missile to enter into EMD.

Figure 7 shows the design validation and technology development process for precision strike missiles. A primary integration tool for the design validation/development process is missile system simulation. The initial simulations used in conceptual and preliminary design are digital simulations. As missile guidance & control hardware becomes available, a hardware-in-loop (HWL) simulation is also developed. HWL simulation incorporates the missile guidance & control hardware (e.g., seeker, gyros, accelerometers, actuators, autopilot). It also includes a simulated target signal for the seeker to track. Hybrid computers are used in HWL simulation. Fast analog computers simulate the rapidly changing parameters, such as the flight trajectory equations of motion. Digital computers simulate the more slowly changing parameters, such as the forces and moments from aerodynamics and propulsion. HWL and digital simulations are the primary system analysis tools used during missile flight tests. For example, simulation results based on wind tunnel data are validated with flight test results. HWL and digital simulations are also used to determine the cause of flight test anomalies.

## New Technologies for Precision Strike Missiles

Figure 8 summarizes new technologies for precision strike missiles. Most of these were covered in this lecture series, however there was insufficient time to address them in detail. Almost all subsystems in precision strike missiles are expected to have major technology improvements in the future. The following is an assessment of new technologies for precision strike missiles, following the format of Figure 8.

**Dome.** New seeker/sensor dome technologies include faceted/window, multi-spectral, and multi-lens domes. Faceted domes are pyramidal-shaped domes that have reduced dome error slope, resulting in improved guidance accuracy. Seeker tracking errors due to the error slope of a traditional high fineness dome are a problem for imaging infrared and radar seekers. Small changes in the curvature of a dome greatly affect the tracking accuracy. An approach that alleviates the problem, previously developed for the Mistral and SA-16 surface-to-air/air-to-air missiles, is a faceted dome. The SLAM ER precision strike missile and ballistic missile defense interceptors also use a similar approach, based on a single flat window. A faceted dome behaves in the same optical manner as a flat window dome, with an advantage of a wider field of regard available to the seeker. The error slope of a faceted/window dome is nearly negligible compared to a traditional high fineness dome. Another advantage of a flat window is reduced observables. A grid or slotted film over the window can be tuned for transmission in the wavelength or frequency of interest. This results in reduced radar scatter, providing reduced radar cross section (RCS) for the precision strike missile. Another dome technology is multi-spectral domes. Multi-spectral domes allow multi-spectral (e.g., mid-wave IR/long wave IR) and multi-mode (e.g., IR/millimeter wave) seekers. Finally, multi-lens domes are concentric high fineness domes that provide optical correction, resulting in low dome error slope. A high fineness multi-lens dome has lower drag at supersonic speed than a traditional hemispherical dome.

**Seeker.** New seeker technologies include multi-spectral, synthetic aperture radar (SAR), strapdown, and uncooled IR seekers. Multi-spectral/multi-mode seekers provide enhanced performance for automatic target recognition. As an example, imaging IR focal plane array (FPA) detectors have the capability to sample multiple wavelengths, providing multi-spectral target discrimination across a broad wavelength. Multi-spectral seekers also have enhanced rejection of false targets and ground clutter. SAR seekers have good effectiveness in adverse weather and ground clutter. SAR seekers have the flexibility to cover a broad area search (e.g., 5 km by 5 km) for single-cell target detection, then switch to high resolution (e.g., 0.3 meter) for target identification and targeting in ground clutter. An example of a SAR sensor is the Predator UAV TESAR. SAR seekers can also provide high-accuracy profiling of the known terrain features around the target and derive the GPS coordinates of the target. Strapdown seekers are seekers without gimbals, using electronic stabilization and tracking. The reduction in parts count by eliminating gimbals reduces the seeker cost, which may be the highest cost subsystem of a precision strike missile. Uncooled IR seekers use an uncooled detector, such as a bolometer. Elimination of a cooling system reduces seeker cost.

**G&C.** Guidance & control technologies include GPS/INS, in-flight guidance optimization, derived angle-of-attack and angle-of-sideslip feedback for bank-to-turn missiles, and automatic target recognition. GPS/INS of the year 2010 is projected to have a precision guidance capability of less than 3 meters circular error probable (CEP). GPS/INS precision accuracy permits a low cost seeker-less missile to be used against fixed targets.

INS sensors that cost about \$20,000 US a decade ago are now a third of the price. The potential exists for a \$2,000 to \$3,000 INS, based on Micro-machined Electro-Mechanical Systems (MEMS) technology. MEMS devices are fabricated from a single piece of silicon by semiconductor manufacturing processes, resulting in a small, low-cost package. Between 2,000 and 5,000 MEMS gyro devices can be produced on a single five-inch silicon wafer. INS sensor alternatives for precision strike missiles include those based on ring laser gyros, fiber optic gyros, digital quartz gyros, and MEMS gyros/accelerometers. Benefits of GPS/INS integration include higher precision position and velocity measurement, reduced sensor noise, reduced jamming susceptibility, and missile attitude measurement capability. A missile operating at high altitude with a modern GPS receiver will have lower susceptibility to jamming. The availability of GPS to continuously update the inertial system allows the design trades to consider a lower precision and less expensive INS, while maintaining precision navigation accuracy (3 meters CEP) and good anti-jam (A/J) performance. Modern GPS/INS receivers are based on a centralized Kalman filter that processes the raw data from all of the sensors (e.g., SAR, GPS receiver, INS). GPS/INS Kalman filters with more than 70 states have been demonstrated for precision strike missiles. In addition to enhanced accuracy, Kalman filters also provide robustness against jamming and the loss of satellites. Pseudo-range measurements can be made from three, two, or even one satellite if one or more of the satellites are lost. GPS/INS guidance is an enabling consideration for precision navigation and the fusion of target sensor data in a clutter environment. GPS accuracy in the Wide Area GPS Enhancement (WAGE), differential or relative modes has sensor hand-off error less than 3 meters. Using in-flight digital trajectory flight prediction and derived flight conditions (e.g., Mach number, angle of-attack, angle-of-sideslip, dynamic pressure) from the GPS/INS, the missile can continuously optimize the flight trajectory to maximize performance parameters such as range, off-boresight, and accuracy. Automatic target recognition will continue to improve as a technology, relieving the workload of the pilot. Advancements in sensor capability for C4ISR will provide new capabilities of near real-time ATR, lower false alarm rate, improved targeting accuracy, and improved data rate.

**Electronics.** Referring to Figure 8, a fourth area of enabling capability is electronics technology. Revolutionary advancements have been made in high performance, low cost commercial off-the-shelf (COTS) processors. This is an enabling technology for guidance & control and sensor data fusion. The capability to process multi-dimensional discrimination in a low cost, small size, and low power package is beginning to emerge. Processing capability has been doubling about every two years, expanding from 2,300 transistors on the 4004 chip in 1972 to 5.5 million transistors on the Pentium Pro chip in 1995. There is no sign that the growth rate will slow down. A projection to the year 2010 predicts a capability of over 1 billion transistors on a chip. Processing capability is ceasing to be a limitation for the application of sensor data fusion and near real-time trajectory optimization to precision strike missiles.

**Airframe.** Airframe technologies are enhancing flight performance, reducing weight, permitting higher flight Mach number, reducing cost, providing higher reliability, and reducing observables. Airframe technologies for precision strike missiles include non-axisymmetric lifting bodies, neutral static margin, split canards, lattice fins, low drag inlets, single cast structures, low cost manufacturing, composites, titanium alloys, MEMS data collection, and low observables. Lifting body airframes provide enhanced maneuverability and aerodynamic efficiency (lift-to-drag ratio). Enhancements in maneuver and cruise performance are also provided by neutral static margin. Split canard control also provides enhanced maneuverability. Another airframe technology that has high payoff for subsonic and supersonic precision strike missiles is lattice fins. Lattice fins have advantages of smaller hinge moment and higher control effectiveness. Another airframe technology is low drag inlets. Low drag inlets are in development for hypersonic missiles. New airframe technology will also reduce the cost of precision strike weapons. Examples of recent precision strike weapons that include low cost technologies include JDAM and JASSM. Technologies to reduce cost are also being introduced into existing weapons, with large savings. An example is Tactical Tomahawk. It has a simple low cost airframe with extruded wings that enables the introduction of low cost commercial parts for G&C and propulsion. The current Tomahawk has 11,500 parts, 2,500 fasteners, 45 circuit cards, 160 connectors, and 610 assembly/test hours. Tactical Tomahawk will have 35% fewer parts, 68% fewer fasteners, 51% fewer circuit cards, 72% fewer connectors, and 68% fewer assembly/test hours – resulting in a 50% reduction in cost. The Tactical Tomahawk also has superior flexibility (e.g., shorter mission planning time, a capability for in-flight targeting, a capability for battle damage indication/battle damage assessment, modular payload) and higher reliability. Tactical Tomahawk demonstrates that reduced parts count is an important contributor to

reducing missile cost. The traditional approach to estimating missile unit production cost has been to base the cost estimate on missile weight. However, Tactical Tomahawk is the same weight as the current Tomahawk, at 50% of the cost. Precision castings will become more prevalent in precision strike missiles. Castings reduce the parts count, with a resulting cost savings. This technology is particularly important to air breathing missiles such as ramjets, which have a more complex non-axisymmetric shape. Ramjets have traditionally been more expensive than axisymmetric rocket powered missiles. A one-piece cast airframe design integrates all of the secondary structure to minimize the structure parts count. Precision tooling minimizes subsequent machine and hand finishing of mating surfaces, by achieving a precision surface finish "as-cast." Fuel cells can be an integral part of the structure and not require bladders. Structural attachment points (e.g., ejector attachments, payload supports, booster attachments) and self-indexing/aligning features can be integral to the structure. This minimizes or eliminates mating, alignment, and assembly tooling and test (inspection) requirements. Precision castings have been demonstrated for missile aluminum, titanium, and steel airframes, motor cases, and combustors. Ceramic tooling is an enabling technology for low cost precision castings. Other manufacturing technologies that reduce airframe cost include vacuum assisted resin transfer molding, pultrusion, extrusion, and filament wind manufacturing of the missile structure. Composite materials will find increased use in new missile airframe structure. High temperature composites particularly have benefits for hypersonic missiles, which require weight reduction. Another technology is titanium alloys. Titanium alloy technology enables lighter weight missiles for a hypersonic, high temperature flight environment. Future precision strike missiles will have low cost/small size MEMS sensors for data collection during missile development and for health monitoring after production. Localized stress, temperature, and other environmental conditions can be monitored through sensors scattered around the airframe. Finally, the airframe shaping and materials technology development for low observable cruise missiles will provide future reduction in observables.

**Power.** Power supply technology is also expected to benefit from the application of MEMS. The energy per weight available from a MEMS power system is much greater than that of thermal batteries. Micro turbine generator technology is based on micro-machined semiconductor manufacturing techniques. It is basically a miniature generator that is powered by a miniature jet engine. A micro turbine generator offers a greater than 15 to 20 times weight and volume advantage.

**Warhead.** Enhanced warhead technologies for precision strike missiles include high energy density warheads, multi-mode warheads, hard target penetrator warheads, submunition dispense, and powered submunitions. Current high explosive warheads have cross-linked double base (XLDB) explosive charges such as HMX and RDX. An example of a new high explosive charge is the US Navy China Lake CL-20. CL-20 is chemically related to current XLDB nitramine explosives. However, CL-20 is a cyclic polynitramine, with a unique caged structure that provides higher crystal density, heat of formation, and oxidizer-to-fuel ratio. CL-20 propellant has 10-20% higher performance than HMX and RDX. CL-20 also has reduced shock sensitivity (class 1.3 versus 1.1) and milder cookoff reaction than either HMX or RDX. There is emphasis to reduce unit production cost and logistics cost by producing a multipurpose missile that covers a broader range of targets. An example is the Joint Standoff Weapon (JSOW). JSOW is a neck-down replacement of Walleye, Skipper, Rockeye, Maverick, and laser guided bombs. A multipurpose weapon system for precision strike is inherently flexible because it can engage a broader target set. A modular warhead provides enhanced capability to engage and defeat hardened, buried targets, and mobile surface targets. Warheads for penetrating deeply buried targets are based on a kinetic energy penetration warhead case that includes a small explosive charge. The technology for kinetic energy penetrator warhead includes penetrator shape, case material, explosive, and fuze to survive and function at high deceleration. Kinetic energy warheads may not require an explosive charge. LOSAT is an example of a hypersonic missile that does not have an explosive charge. In the area of submunitions, submunition dispense and powered autonomous submunitions such as LOCAAS have the capability to counter mobile, time critical targets such as TBMs. A powered submunition can search a relatively large area, providing the potential for locating a TBM launcher after the launch site has been vacated. This provides robustness against uncertainties in the time lines for C4I and target dwell. A technical challenge is supersonic/hypersonic dispense of submunitions. The flight environment of high dynamic pressure and shock wave-boundary layer interaction is relatively unexplored. Aft dispense of submunitions is an enabling technology for supersonic/hypersonic submunition dispense.

**Insulation.** Referring again to Figure 8, an eighth area of enabling capability is insulation technology. Higher density external airframe and internal insulation materials are in development for hypersonic missiles. Most precision strike missiles are volume-limited rather than weight limited. Higher density insulation materials permit more fuel/propellant, resulting in longer range.

**Propulsion.** Emerging propulsion technologies include liquid fuel ramjet, variable flow ducted rocket, scramjet, slurry fuel, endothermic fuel, composite motor case, rocket motor energy management, low observables, high thrust motor, and reaction jet control. Turbofan and turbojet propulsion systems are relatively mature technologies for precision strike missiles. They are most suited for subsonic cruise missiles, providing high efficiency to deliver a warhead at long range against non-time-critical targets. Turbofans/turbojets have an operating regime to about Mach 3. However, beyond Mach 2, increasingly complex inlet systems are required to match delivered inlet airflow to compressor capacity, and expensive cooling systems are required to avoid exceeding material capabilities at the turbine inlet. Liquid fuel ramjet propulsion provides high specific impulse for efficient cruise at a Mach number of about 4 and an altitude of about 80,000 feet. Above Mach 5, deceleration of the inlet airflow to subsonic velocity results in chemical dissociation of the air, which absorbs heat and reduces the useful energy output of the combustor. Also, two or more oblique shock compressions are required for efficient inlet pressure recovery at a Mach number greater than 5.0, adding to the complexity, cost, and integration risk of a ramjet missile. Variable flow ducted rocket propulsion has advantages of higher acceleration than a liquid fuel ramjet and longer range than a solid rocket. For precision strike missions, it is particularly applicable to the suppression of long range, high performance SAMs. The ducted rocket acceleration and fast response to Mach 3+ provides short response time for an anti-SAM engagement. Ducted rockets utilize a gas generator to provide fuel-rich products to the combustor. The fuel-rich products mix and burn with the air from the inlet. The specific impulse of a ducted rocket is between that of a liquid fuel ramjet and a solid rocket. Supersonic combustion ramjet (scramjet) propulsion is most efficient for cruise Mach numbers 6 or greater. The scramjet maintains supersonic flow throughout the combustor. A technical challenge for the scramjet is fuel mixing and efficient combustion. There are extremely short residence times for supersonic combustion. Another technical challenge is inlet integration for efficient pressure recovery. Like the ramjet, the scramjet is rocket boosted to a supersonic takeover speed. The takeover speed of a scramjet is about Mach 4.5, higher than a ramjet, requiring a larger booster. For a weight-limited system, a scramjet missile will have less available fuel than a ramjet missile. An efficient cruise condition for a scramjet is about Mach 6, 100K feet altitude. Fuel technologies include slurry fuels and endothermic fuels. High density slurry fuels provide high volumetric performance for volume-limited missiles. Endothermic fuels decompose at high temperature into lighter weight molecular products, providing higher specific impulse and permitting shorter combustor length. Endothermic fuels also provide cooling of the adjacent structure. Another propulsion technology is composite motor cases. Composites provide reduced weight compared to a steel motor case. Thrust-time history management technologies for rocket motors include pintle, pulsed, and gel propellant motors. In the area of low observable precision strike missiles, the emphasis on reduced observable plumes will continue in the foreseeable future. Finally, kinetic kill precision strike missiles use high thrust motors to quickly accelerate to hypersonic speed. Kinetic kill missiles also employ reaction jet control for hit-to-kill accuracy.

**Data Link.** New data link technologies include battle damage indication/battle damage assessment (BDI/BDA), in-flight targeting, and phased array antennas. BDI/BDA can be provided by a data link of target imagery from an imaging IR seeker. In-flight targeting is particularly useful against mobile, time critical targets such as TBMs. Phased array antennas are in development that provide high data rate and flexibility for a precision strike missile to communicate with satellites, ground stations, manned aircraft, and UAVs.









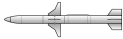

**Flight Control.** A final area is that of flight control technology for precision strike missiles. The requirement for internal carriage on low observable aircraft has driven new technology in compressed carriage (e.g., small-span/long-chord, folded, wraparound, switchblade) aerodynamic surfaces. This allows higher firepower load-outs for internal carriage on low observable aircraft such as the F-22.



Area	Emphasis
Aerodynamics	●
Propulsion	●
Structure / Materials	●
Guidance & Control	●
Seeker	●
Missile Design	●
GPS / INS Sensor	●
Missile / Aircraft Integration	●
Simulation / Validation	●
ATR	●
Mission Management	●
Data Link	○
Cost / Logistics	○
Observables / Survivability	○

● Emphasis      ○ Less Emphasis

Figure 1. Emphasis of This Lecture Series Is on Technologies for Precision Strike Missiles.

Precision Strike Missile Characteristics	Example of State-of-the-Art	Comparison With Fighter Aircraft
Acceleration	 AGM-88	●
Maneuverability	 AGM-114	●
Speed	 AS-17 / Kh-31	●
Dynamic pressure	 ANS	●
Size	 LOCAAS	●
Weight	 LOCAAS	●
Production cost	 GBU-31	●
Observables	 AGM-129	◐
Range	 AGM-86	-
Kills per use	 Apache	-
Target acquisition	 LOCAAS	-

● Superior      ◐ Better      ○ Comparable      - Inferior

Figure 2. Air-Launched Precision Strike Missiles Are Different from Fighter Aircraft.

◆ Anti-Fixed Surface Target Missiles ( large size, wings, subsonic, blast frag warhead )



◆ Anti-Radar Site Missiles ( ARH seeker, high speed, blast frag warhead )

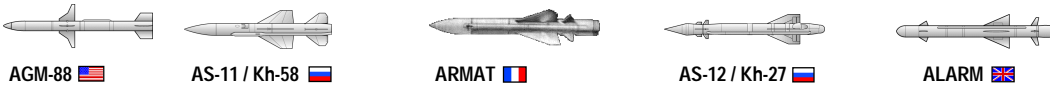

◆ Anti-Ship Missiles ( large size, blast frag warhead, and high speed or low altitude )



◆ Anti-Armor Missiles ( small size, hit-to-kill, low cost, shape charge / EFP / KE warhead )

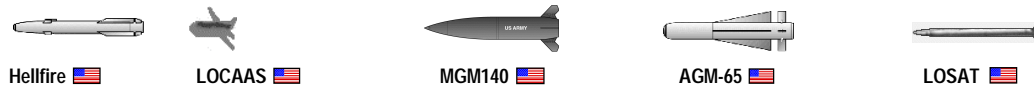

◆ Anti-Buried Target Missiles ( large size, high fineness / penetrating warhead )



Permission of Missile Index. Copyright 1997©Missile.Index All Rights Reserved

Figure 3. Examples of Precision Strike Missiles.

Alternatives for Precision Strike	Cost per Shot	Number of Launch Platforms Required	TCT Effectiveness
<b>Future Systems</b>			
◆ Standoff platforms / hypersonic missiles	○	●	◐
◆ Overhead loitering UCAVs / hypersonic missiles	◐	◐	●
◆ Overhead loitering UCAVs / light weight PGMs	●	○	◐
<b>Current Systems</b>			
◆ Penetrating aircraft / subsonic PGMs	●	—	—
◆ Standoff platforms / subsonic missiles	○	●	—
Note: ● Superior      ◐ Good      ○ Average      — Poor			

Note: C4ISR targeting state-of-the-art for year 2010 projected to provide sensor-to-shooter connectivity time less than 2 minutes and target location error ( TLE ) less than 1 meter.

Figure 4. Projected Future Capability of Precision Strike Missile Systems.

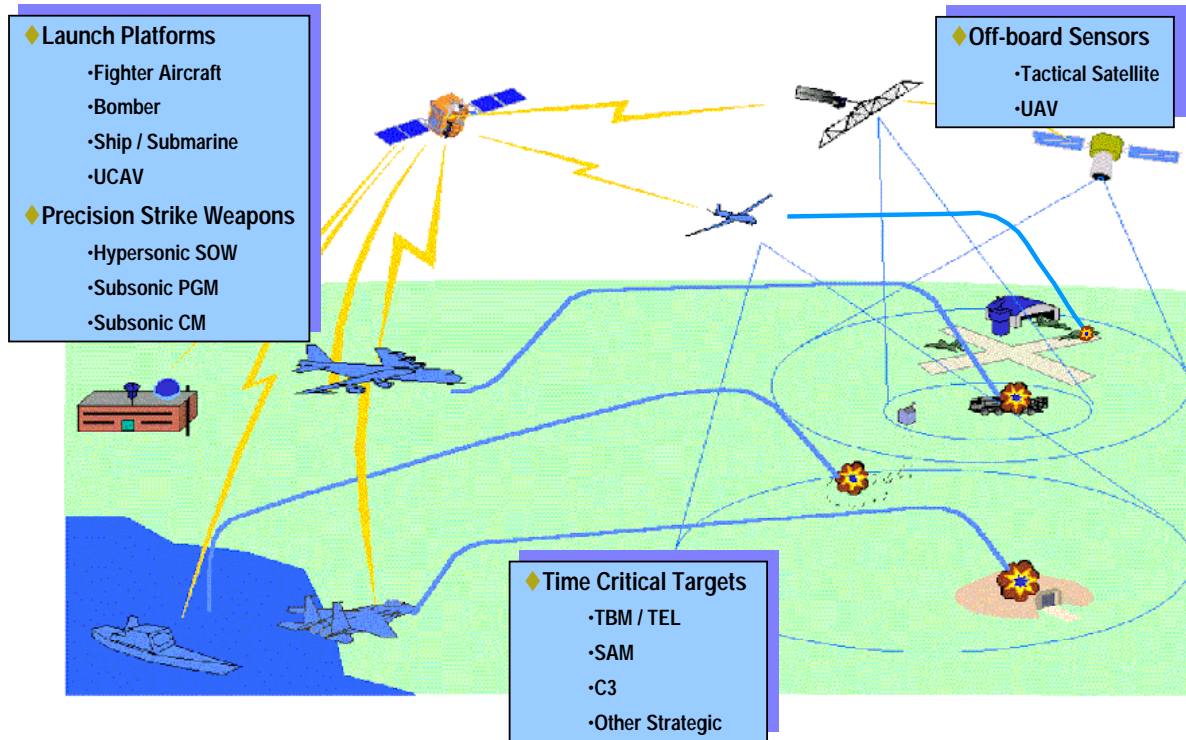

Note: C4ISR targeting state-of-the-art for year 2010 projected to provide sensor-to-shooter connectivity time less than 2 minutes and target location error ( TLE ) less than 1 meter.

Figure 5. Future C4ISR Tactical satellites and UAVs Will Provide Targeting Against Time Critical Targets.

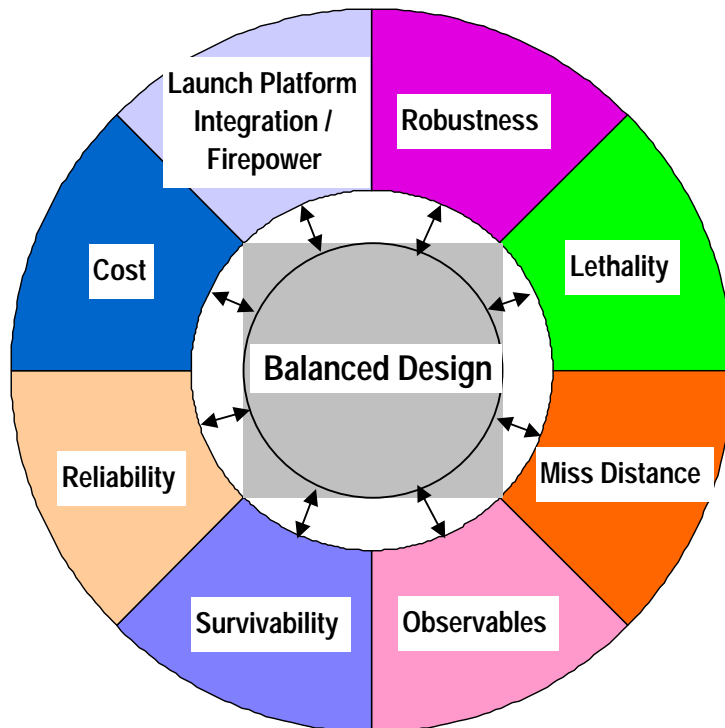

Figure 6. Measures of Merit and Launch Platform Integration Should Be Harmonized.

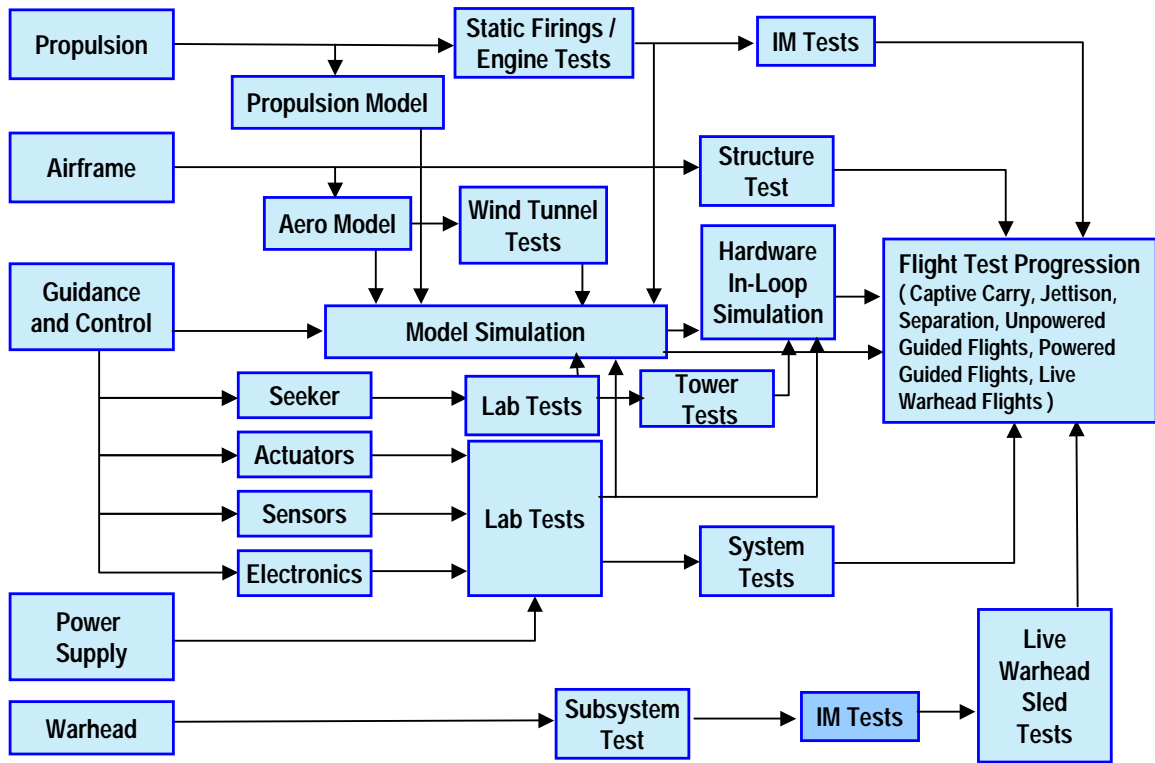

Figure 7. Missile Design Validation/Technology Integration Is An Integrated Process.

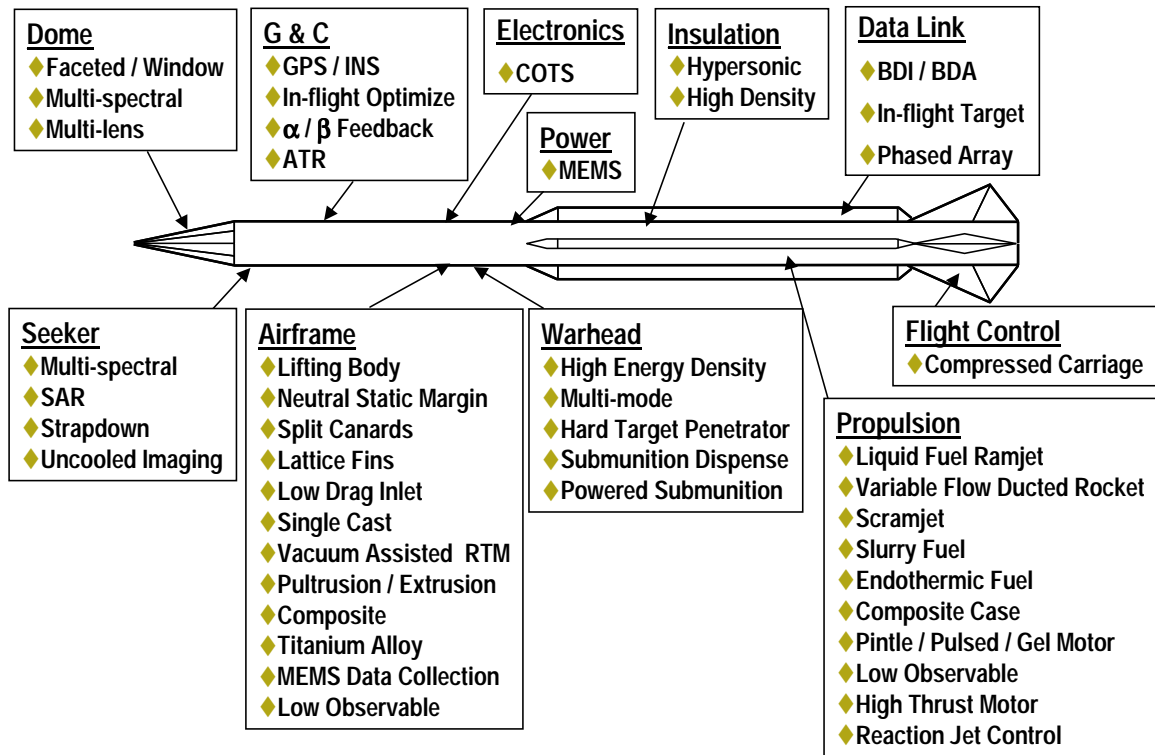

Figure 8. New Technologies for Precision Strike Missiles.

# Mission Planning Technology

**Erik Berglund**

Swedish Defence Research Agency  
172 90 Stockholm, Sweden  
erik.berglund@foi.se

## Summary

Some important aspects of mission planning are briefly outlined. More detailed discussions concern the missile's ability to avoid enemy air defences and to resist point defence.

Both the option of using low observables technology and the option of using terrain masking at low altitude are found to be viable techniques to avoid enemy air defences. It is argued that it is useful for the missile to employ countermeasures, such as manoeuvres, in the final kilometres.

The new threats to missiles posed by GPS jamming and anti-sensor lasers are briefly outlined.

A short discussion on the possibilities for mission planning opened up by the progress in information technology is included.

## Introduction

Mission planning forms an important part of a successful strike with long range stand-off weapons. The most crucial aspects of the mission planning is, of course, to make sure that the missile finds its target and that it survives up until impacting the target.

The problem of penetrating enemy air defences is of concern for most sorts of aerial vehicles: manned aircraft, unmanned aerial vehicles (UAVs) and missiles. In particular manned aircraft and anti-ship missiles, have long faced the problem of penetrating advanced enemy air defences. Long range strike missiles are, in most scenarios, likely to face some enemy air defences.

Enemy air defences are often multi-tiered systems made up by interceptor aircraft, surface-to-air weapons, and electronic warfare.

The problem of defence penetration can basically be divided into:

- Destruction/suppression of the enemy air defences
- Avoiding enemy air defences
- Surviving enemy air defences

The following text will first focus on defence penetration by long range, stand-off strike missiles. Most of the discussion is, however, applicable also to other aerial vehicles. Then follows a discussion on a more network oriented approach to missile employment.

## Suppression of Enemy Air Defences

Suppression and possibly destruction of enemy air defences plays an important role in air warfare. Long range strike missiles are likely to be used against the enemy air defences in conjunction with other components such as electronic warfare. Enemy air defences could also be suppressed by various means to facilitate an attack by strike missiles on other targets.

## Avoiding Air Defences

A common means of defence penetration is to attempt to avoid detection until it is too late for the defences to react in an effective manner. Avoiding, or delaying, detection can be accomplished by various means, e.g.:

- Low observables.
- High altitude, exploiting altitude limitations in threat sensors.
- Low altitude, exploiting terrain masking and propagation properties.

The predominant sensor used in air defence systems is the radar. Other sensors are infra red search and track (IRST) and radar warning receivers (RWR).

The detection range of a radar depends heavily on:

- Radar parameters (power, frequency, gain, noise levels etc)
- Antenna height
- Sea state (at sea)
- Terrain (on land)
- Atmospheric conditions
- Target altitude
- Target radar cross section (RCS)
- Electronic warfare environment

The radar equation in its simplest form gives the maximal range in free space as:

$$R_{\max} = \sqrt[4]{\frac{PG^2\lambda^2\sigma}{(4\pi)^3 S_{\min}}}$$

where

$P$  is the power of the radar

$G$  is the antenna gain of the radar

$\lambda$  is the wavelength

$\sigma$  is the target radar cross section (RCS)

$S_{\min}$  is minimal detectable returned signal

Low observables technology can be used to reduce the radar cross section of the strike missile. A combination of careful design of the geometrical shape of the missile and application of non-reflective materials can be used to reduce the RCS. The radar equation gives that a tenfold reduction of the RCS results in a reduction in radar range of 44%.

The predominant US concept of avoiding detection currently seems to be based on stealth technology and high altitude operations. This is a concept of operation that exploits the fact that most surveillance radar systems have been designed to detect normal targets up to reasonable altitudes, say 20,000 meters. As the detection range of the radar is reduced against stealthy targets, the altitude limits are also reduced. This makes it possible to fly above the ceiling of the radar as shown in figure 1.

Also against infra red sensors, the missile can employ low observables technology, e.g. reflective coatings to reflect the cold sky toward the threat sensor. IR low observables is much aided if the missile flies at a low altitude to exploit the background clutter.

An alternative solution to the problem of avoiding detection is to fly at low altitude to exploit propagation properties and terrain masking. As figures 2 and 3 show, low altitude has a great pay-off in reducing the detection range both in the anti-ship case and in the land attack case. At low altitude the detection range of enemy air defence sensors is already so highly limited by the physics of the environment, i.e. terrain masking and transmission properties, that there seems to be less pay-off for low observables. However, flying at extremely low altitude also has drawbacks, e.g. high fuel consumption and risk of crashing. Furthermore the

footprint of the missile's seeker becomes small as the missile flies low. Flying low to exploit terrain masking consequently requires significant amounts of mission planning.

An important sensor for early warning of a missile attack, especially for ships, is the radar warning receiver (RWR). To remain undetected for as long as possible it is therefore vital that anti-ship missiles can stay silent for as long as possible. It is also useful for the missile to have a low probability of intercept (LPI) seeker.

## Surviving Air Defences

The option to try to survive the enemy air defences is, of course, a last resort. However, an incoming strike missile is likely to face some point defence system defending a high value target, which would be difficult to completely avoid. Many of the concepts of aircraft survivability as treated by Ball (1985) also apply to missiles.

The threat systems can be either or both of soft kill systems and hard kill systems, e.g.:

- Jamming of GPS signals
- Jamming of radar seekers
- High Power Microwave (HPM) weapons
- Laser jamming of optical seekers
- Air defence guns
- Surface-to-air missiles
- Air-to-air missiles

As precision navigation systems partly based on the GPS system become more common and also more important in many systems, including precision strike weapons, it is obvious that GPS countermeasures become more interesting. An incoming strike missile would have to be designed to cope with GPS jamming. Much can be achieved by anti-jam features, such as directional antennas and signal processing. However, the most important part would be the use of an integrated navigation system based on inertial navigation and GPS. If the GPS receiver is jammed in the final part of the trajectory, the inertial system guides the weapon with adequate precision.

Other recent additions to the threat against aerial vehicles are directed energy weapons such as High Power Microwave (HPM) and anti-sensor laser. An HPM weapon is capable of jamming or even destroying unprotected electronics at fairly long distances. However, most missiles are protected against electromagnetic interference, which makes them a more difficult target for HPM weapons.

Anti-sensor lasers can use various concepts. At the lower end of the power spectrum the laser would operate in the same frequency range as the sensor and cause the sensor to lose track by generating strange patterns in the image (figure 4) or by completely blanking out the sensor. At higher ends of the power spectrum the laser could destroy the sensor or even the front end optics.

In order to survive the classical air defence systems, i.e. guns and surface to air missiles, the incoming strike missile could use:

- High speed to reduce the reaction time
- Saturation
- Low observables
- Electronic countermeasures
- Hardening
- Evasive manoeuvres

Saturation can be achieved by careful co-ordination between several attacking missiles or by using decoys. A possible development could well be for advanced strike missiles to carry their own decoys to be employed in the terminal phase.

Low observables could make it possible for the missile to exploit some design limitations in the weapons. However the pure physics of a close range encounter would not make it possible for the incoming missile to remain undetected.

Electronic countermeasures can be used to degrade the performance of the enemy air defences. Jamming can be provided by friendly manned aircraft or unmanned UAVs. A possible development could be to equip some strike missiles with onboard or off-board jammers.

To harden the missile enough for it to fully survive a hit, does not seem to be feasible. However, the missile could be designed to avoid unnecessary catastrophic events close to its target. For example the missile could be designed to stay on course even if the seeker is knocked out. Premature detonation or deflagration of the warhead should also be prevented, e.g. by the use of insensitive explosives.

Evasive manoeuvres can be used as a countermeasure against both anti-air missiles and anti-aircraft guns. Evasive manoeuvres against anti-air missiles are covered in the Guidance and Control chapter. Manoeuvres are especially effective against guns, due to the relatively long time of flight of the unguided projectiles.

Berglund (1998) shows that the effective range of anti-aircraft guns decreases very rapidly even for moderate target manoeuvres, figure 5. A simple rule of thumb for the effective range of a gun is developed as

$$R = \sqrt[3]{\frac{4fr^2v^4}{3ua^2 \ln \frac{1}{1-P_k}}}$$

where

$R$  = effective range [m]

$f$  = rate of fire [rounds/s]

$r$  = lethal radius [m]

$v$  = projectile velocity [m/s]

$u$  = target velocity [m/s]

$a$  = target lateral acceleration [m/s<sup>2</sup>] ( $a > 0$ )

$P_k$  = required kill probability

## Networking

Recent technological progress has made it possible to use information technology to integrate functions both within a weapon system and between systems much closer than previously possible. Buzzwords such as “network centric warfare” and “systems of systems” have been introduced to emphasise the importance of this development.

To integrate a long range strike missile in a network oriented system of system would in most cases require a communication link to and from the missile. That link could be an RF link, such as the satellite link in the upgraded versions of the Tomahawk cruise missile, or a fibre optic link, such as in the European Polyphem missile.

The communication link to the missile allows re-planning of the mission and updates of the target position. The link from the missile makes it possible to use the information from the missile sensors as inputs in the intelligence system. Information from the missile can also be used for bomb damage assessment.

Communication with the missile also makes it possible to use targeting data from off-board sensors to guide the missile. To be able to use the information from off-board sensors, the missile would need to have a high precision navigation system. Furthermore the targeting data must not only be accurate, it must also be updated often enough given the dynamics of the target.



The use of reliable off-board target data would more or less revolutionise some strike missions. First of all much cheaper missiles without advanced seekers could be employed. Furthermore in the anti-ship case, where the radar warning receivers usually provide the ships with the first warning, silent attacks would become possible.

The use of communication can also be extended to include communication between missiles in a salvo. This could facilitate features such as dynamic re-planning due to loss of one of the missiles or information from onboard or off-board sensors. Assignment of targets could also be co-ordinated between the missiles.

## **Mission Planning Tools**

The planning of a strike mission employing long range missiles is a truly multidimensional problem. The objective of the strike is most often to achieve some more or less political result. To achieve the desired political objective it is often necessary to avoid collateral damage and, of course, to follow the stipulated rules of engagement.

When the target has been selected, the planning needs to consider the vulnerability of the target and select a suitable weapon to defeat it. Also the defences surrounding the target need to be analysed carefully.

Computer models are frequently used to select flight paths to the target area that give a low risk of detection by the enemy air defence system. Computer models can also be used to determine suitable routes in the target area, enabling the incoming strike missile to lock on to the target, while avoiding possible point defence systems.

This planning has normally taken place prior to launching the mission. However, the advances in information technology have now made dynamic re-planning during the mission possible. That re-planning can take place both in the command centre and onboard the missile itself.

## **Conclusion**

Mission planning forms a crucial part of a strike with long range missiles. Important aspects are to make sure that the target area is reached and that the missile impacts the right target.

Both the concept of flying high and rely on low observables and the concept of flying low and rely on terrain masking make it likely that the missile can avoid detection by enemy air defences on the ingress to the target area. However, the option of terrain masking requires more detailed mission planning.

To avoid point air defence systems in the target area, it would be useful for the missile to employ evasive manoeuvres and other countermeasures during the last 5 to 10 km.

Strike missiles need to be hardened against GPS jamming, laser jamming aimed at optical seekers, and jamming aimed at any radar seekers.

The advances in information technology open new possibilities of dynamic re-planning during the mission and of collaboration between missiles.

## **References**

Alvå P., Andersson F., Wallström D., *Collaborating missiles system - A Study*, FOA-R--00-01799-314—SE, Swedish Defence Research Agency, 2000. (In Swedish)

Ball R.E., *The Fundamentals of Aircraft Combat Survivability Analysis and Design*, AIAA, 1985.

Berglund E., *Defence against Incoming ASMs*, presented at VIth European Air Defence Symposium, Shrivenham 19-21 May, 1998.

Hansson M-B and Berglund E, *Swedish Experiences from Air Defense Models*, AIAA Paper 99-4025, presented at AIAA Modeling & Simulation Technologies Conference, Portland, 9-11 August, 1999.

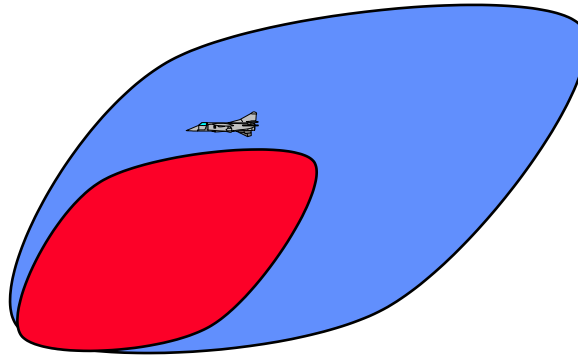

Figure 1. A stealthy aircraft or missile exploits the altitude limit of a surveillance radar, which has been reduced from its nominal value by the target's low RCS.

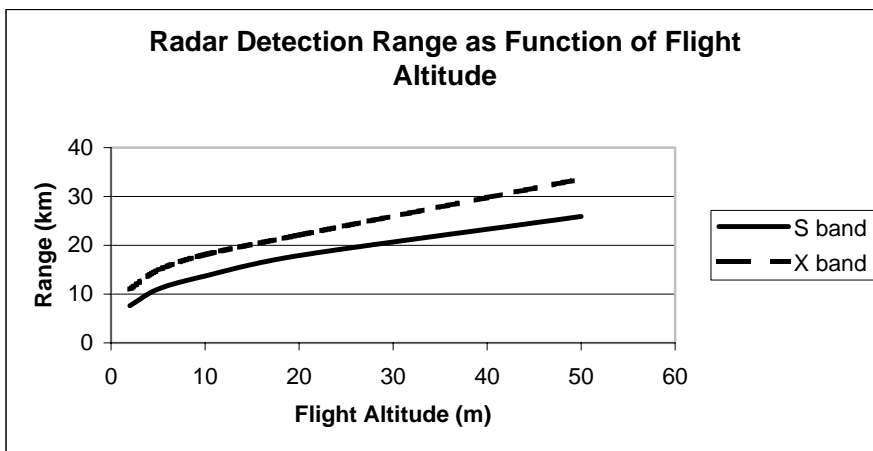

Figure 2. The detection range of a ship-borne radar against an anti-ship missile as function of missile altitude. The nominal range of the radar is 30 km and the antenna is at 10 meters elevation. It can be noted that the propagation properties in this case result in a range for the X band radar against the 50 meter altitude target that is greater than the nominal, free space range. (From Berglund, 1998)

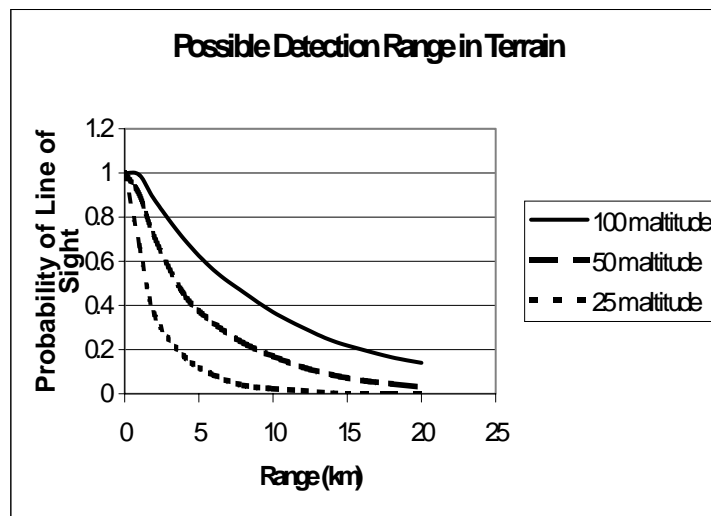
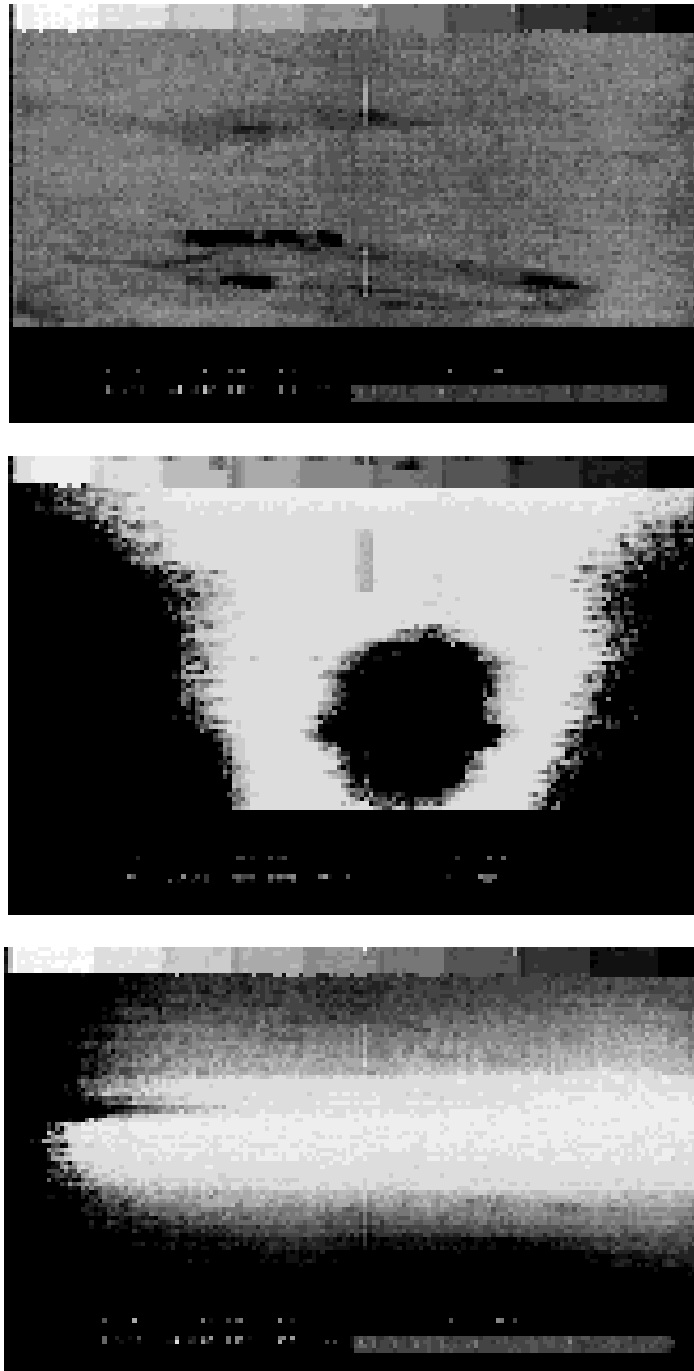

Figure 3. The probability of an air defence unit having line of sight to a target as function of range for different target altitudes in Mid-Swedish terrain. In this case the sensor is mounted on a 12 meter mast. (From Hansson and Berglund, 1999)



**Figure 4. Examples of FLIR jamming. Top un-jammed image of target region with laser. Middle, jamming inside the field of view of the FLIR and bottom jamming outside the field of view. (Swedish Defence Research Agency)**

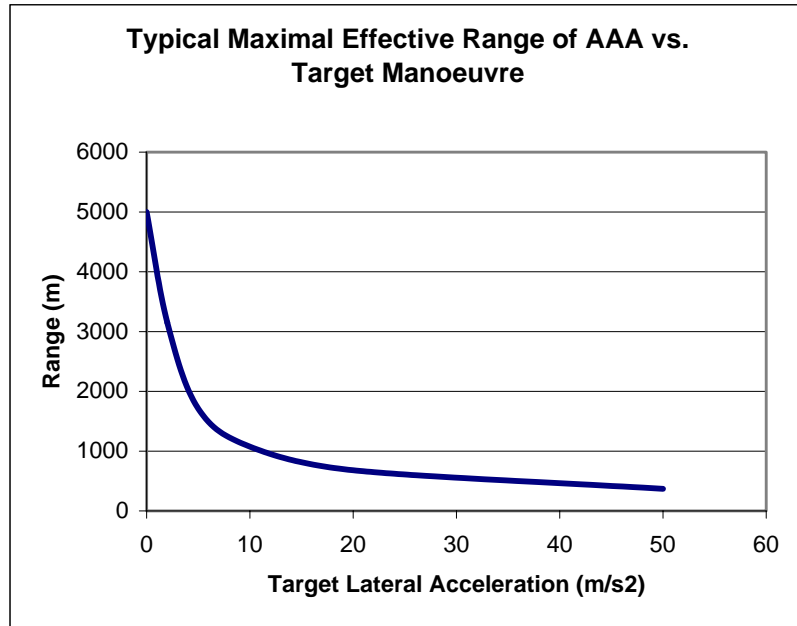

Figure 5. The effect of evasive manoeuvres on the range of a typical medium calibre anti-aircraft gun firing proximity fused ammunition at an incoming subsonic anti-ship missile.

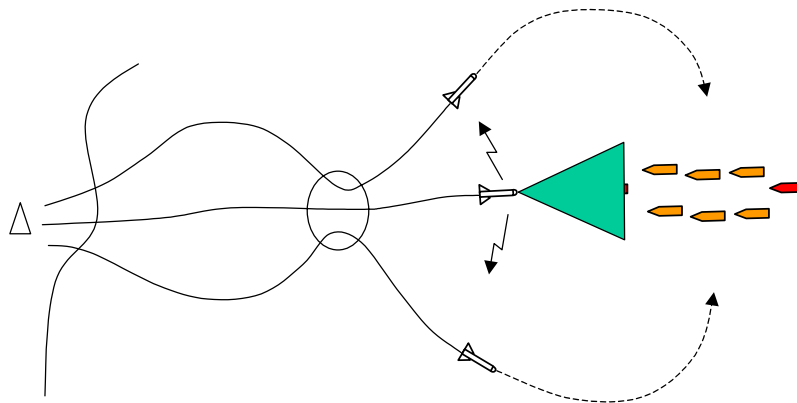

Figure 6. Communication between the anti-ship missiles in a salvo enables a tactic where only one missile activates its seeker while the others receive target data from the active missile and stay silent until the final approach. (From Alvå et al., 2000)

# Technologies for Future Precision Strike Missile Systems - Missile Aeromechanics Technology

**Eugene L. Fleeman**

Aerospace Systems Design Laboratory  
School of Aerospace Engineering  
Georgia Institute of Technology  
Atlanta, Georgia 30332-0150, United States  
[Eugene.Fleeman@asdl.gatech.edu](mailto:Eugene.Fleeman@asdl.gatech.edu)

## Abstract/Executive Summary

This paper provides an assessment of the state-of-the-art of new aeromechanics technologies for future precision strike missile systems. The aeromechanics technologies are grouped into specific discussion areas of aerodynamics, propulsion, and airframe materials technologies. Technologies that are addressed in this paper are:

- **Missile aerodynamics technologies.** Assessments include aerodynamic configuration shaping, lattice tail control, split canard control, forward swept surfaces, bank-to-turn maneuvering, and flight trajectory shaping.
- **Missile propulsion technologies.** Assessments include supersonic air breathing propulsion, high temperature combustors, low drag ramjet inlets, ramjet inlet/airframe integration, higher density fuels, rocket motor thrust magnitude control, high thrust motor, and reaction jet control.
- **Missile airframe materials technologies.** Assessments include hypersonic structure materials, composite structure materials, hypersonic insulation materials, multi-spectral domes, and reduced parts count structure.

## Introduction

Missile aeromechanics technologies have benefits that include enhanced flight performance, reduced weight, increased Mach number, reduced cost, higher reliability, and reduced observables. Figure 1 summarizes new aeromechanics technologies for precision strike missiles. Most of the technologies in the figure are covered in this paper, however there was not sufficient time to address them all. A summary of other new aeromechanics technologies is presented in the Introduction/Overview paper of this lecture series.

## Missile Aerodynamics Technologies

This assessment of missile aerodynamics technologies addresses six new enabling technologies. These are aerodynamic configuration shaping, lattice tail control, split canard control, forward swept surfaces, bank-to-turn maneuvering, and flight trajectory shaping.

**Aerodynamic Configuration Shaping.** Figure 2 illustrates aerodynamic configurations that are highly tailored, using aerodynamic shaping of lifting body configurations. An advantage of a tailored lifting body missile is higher aerodynamic efficiency (lift-to-drag ratio) for extended range cruise performance and enhanced maneuverability. Also shown in Figure 2 is the synergy of tailored missiles with reduced radar cross section. Tailored missiles are also synergistic with ramjets for areas such as inlet integration and liquid hydrocarbon fuel packaging. Disadvantages of tailored missiles include their relative inefficiency for solid subsystems packaging and an adverse impact on launch platform integration, due to a larger span. Improved methods and tests are required for the prediction of the aerodynamics and the structural loads of non-axisymmetric weapons. This includes more extensive wind tunnel tests, computational fluid dynamics (CFD) predictions, and finite element modeling (FEM) of structural integrity.

**Lattice Tail Control.** Another example of new aeromechanics technology is lattice tail control. Lattice fins have advantages of lower hinge moment and higher control effectiveness at supersonic Mach number. Figure 3 shows a comparison of lattice tail control with two conventional approaches to tail control - all movable control and flap control. Except for radar cross section, lattice tail control has good-to-superior performance for supersonic missiles. Also shown in the figure are examples of supersonic missiles with tail control alternatives of lattice tail control (Adder AA-12), all movable tail control (ASRAAM AIM-132), and flap tail control (Hellfire AGM-114). The smaller chord length of the lattice has less variation in the center of pressure, resulting in lower hinge moment for lattice tail control. Lattice fins are most appropriate for either subsonic or high supersonic missiles. At subsonic Mach number the drag of lattice fins is comparable to that of traditional flight control. At transonic Mach number, lattice fins have higher drag and lower control effectiveness than traditional flight control. At a low transonic free stream Mach number less than 1, the local flow through the lattice accelerates to Mach 1, choking the flow (see Figure 4). For a transonic free stream Mach number slightly greater than 1, the flow through the lattice remains choked. A detached, normal shock wave in front of the lattice spills excess air around the lattice. The lattice remains choked until the supersonic Mach number is sufficiently high to allow the lattice to swallow the shock. An oblique shock is then formed on the leading edge of each surface of the lattice. At low supersonic Mach number the oblique shock angle is large. Each oblique shock is reflected downstream, off an adjacent lattice surface, resulting in increased drag. At higher Mach number the oblique shock angle is smaller, passing through the lattice without intersecting a lattice surface. In summary, lattice fins have their best application at low subsonic and high supersonic Mach number, where they have low drag and high control effectiveness.

**Split Canard Control.** Modern highly maneuverable missiles are using split canards for flight control. Split canard control has a fixed surface in front of the movable canard. Figure 5 is a schematic of the local flow that illustrates the advantage of split canards. The incremental normal force coefficient,  $\Delta C_N$ , in the figure is the difference between the normal force coefficient of the deflected control surface and the normal force coefficient of an undeflected control surface. Note that the forward surface reduces the local effective angle of attack ( $\alpha'$ ). Because the trailing canard control surface has a smaller local angle of attack, it is more effective at higher control surface deflection,  $\delta$ , and higher angle of attack,  $\alpha$ , operating without stall. All modern canard control missiles use split canard control including Kegler AS-12, Archer AA-11, Aphid AA-8, Magic R-550, Python 4, and U-Darter.

**Forward Swept Surfaces.** Forward swept surfaces are an alternative to the traditional aft swept surfaces for missile canards, tails, and wings. Forward swept surfaces are particularly beneficial for missiles that require low radar cross section (RCS) or have small span requirements for aircraft compatibility. A forward swept wing has low frontal RCS because the wing sweep and the attenuation of backscatter bouncing off the adjacent body. Figure 6 is a comparison of a forward swept leading edge surface with conventional planform surfaces that are triangular (delta), trapezoidal with an aft swept leading edge, and rectangular. In addition to a low RCS and smaller span, forward swept surfaces have good-to-superior characteristics of low variation in aerodynamic center, low bending moment, low supersonic drag, and high control effectiveness. An inherent disadvantage of a forward swept surface is increased potential for aeroelastic instability. Composite structure is synergistic with forward swept surfaces because the higher stiffness of composites mitigates aeroelastic instability. Composite material may also be used in radar absorbing structure. The U.S. AGM-129 Advanced Cruise Missile and the Russia AA-10 are examples of missiles with a forward swept wing.

**Bank-to-turn Maneuvering.** Figure 7 compares bank-to-turn maneuvers with maneuver alternatives of skid-to-turn and rolling airframe. Missiles using bank-to-turn will first roll until the wings or the major axis of a lifting body are oriented perpendicular to the target line-of-sight. Following the roll maneuver, the missile then maneuvers in pitch, maintaining the preferred roll orientation. A benefit of bank-to-turn maneuvering is higher maneuverability for a lifting body with noncircular cross section or for a missile with wings. Another benefit is smaller sideslip angle for missiles with inlets. Bank-to-turn is particularly suited for mid-course guidance maneuvers prior to seeker lock-on to the target. A disadvantage of bank-to-turn maneuvering is slower response in terminal maneuvers and larger variation in dome error slope that could degrade guidance accuracy, increasing the missile miss distance. Alternative approaches to alleviate this problem include faster

actuators for roll control, faceted or multi-lens dome, and switching from bank-to-turn maneuvering to skid-to-turn maneuvering for terminal flight.

**Flight Trajectory Shaping.** Figure 8 illustrates the extended range advantage of precision strike missiles that use flight trajectory shaping. Flight trajectory shaping is particularly beneficial for high performance supersonic missiles, which have large propellant or fuel weight fraction. To take advantage of flight trajectory shaping, the missile must rapidly pitch up and climb to an efficient cruise altitude. During the climb, the missile angle-of-attack should be small, to minimize drag. The missile initial thrust-to-weight ratio should be relatively high (~10) for safe separation, followed by a relatively low thrust-to-weight ratio (~2) during climb. A climb thrust-to-weight ratio greater than about two will result in high dynamic pressure, increasing drag. After reaching higher altitude, the missile benefits from cruising at improved lift-to-drag ratio, or aerodynamic efficiency. Dynamic pressure for efficient cruise of a low aspect ratio missile is of the order of 500 to 1,000 pounds per square foot. Following burnout, the missile can also have extended range through glide at a dynamic pressure of about 700 pounds per square foot.

## Missile Propulsion Technologies

The assessment of missile propulsion technologies addresses eight enabling technologies. These are supersonic air breathing propulsion, high temperature combustors, low drag ramjet inlets, ramjet inlet/airframe integration, higher density fuels, rocket motor thrust magnitude control, high thrust motor, and reaction jet control.

**Supersonic Air Breathing Propulsion.** Ramjets, scramjets, and ducted rockets have high payoff for precision strike missiles operating at supersonic/hypersonic Mach number. A comparison of the specific impulse performance of ramjet, scramjet, and ducted rocket propulsion, along with that of solid rocket and turbojet propulsion, is given in Figure 9.

Turbojet and turbofan propulsion is a relatively mature technology for precision strike missiles. Turbojets/turbofans are most suited for subsonic cruise missiles, providing high efficiency to deliver a warhead at long range against non-time-critical targets. The operating regime is to about Mach 3. However, beyond Mach 2, increasingly complex inlet systems are required to match delivered inlet airflow to compressor capacity, and expensive cooling is required to avoid exceeding material temperature limit at the turbine inlet.

Solid rockets are capable of providing thrust across the entire Mach number range. Although the specific impulse of tactical rockets is relatively low, of the order of 250 seconds, rockets have an advantage of much higher acceleration capability than air-breathing propulsion. Solid rocket boosters are used to boost ramjets to their take-over Mach number of about 2.5, for transition to air-breathing propulsion.

The maximum specific impulse of a liquid hydrocarbon fuel ramjet is about 1,500 seconds, much higher than the specific impulse of a solid rocket. An efficient cruise condition for a ramjet is about Mach 4, 80K feet altitude. Above Mach 5, the combustor material maximum temperature limits the achievable exit velocity and thrust. Also, the deceleration of the inlet airflow to subsonic velocity results in chemical dissociation of the air, which absorbs heat and negates a portion of the energy output of the combustor. Liquid fuel ramjets are synergistic with noncircular, lifting body airframes because ramjet fuel can be stored in noncircular tanks. Liquid fuel ramjets can be throttled, for efficient matching of the fuel with the inlet airflow. Throttling provides higher thrust and specific impulse over a broader flight envelope of Mach number and altitude. A rocket booster is required to boost the ramjet up to a speed where the ramjet thrust is greater than the drag of the missile. Ramjet takeover speed is about Mach 2.5.

Above Mach 6, a supersonic combustion ramjet (scramjet) provides higher performance than a ramjet. The minimum sustained flight Mach number of a scramjet, based on providing sufficient thrust to overcome missile drag, is greater than about Mach 4.0. The maximum Mach number, based on engine material temperature limit, is about Mach 8 to 9. An efficient cruise condition for a scramjet is about Mach 6, 100K feet altitude. A key technical challenge is fuel mixing for efficient supersonic combustion. There are

extremely short residence times for supersonic combustion. An enabling technology to enhance supersonic combustion is endothermic fuels. Endothermic fuels decompose at high temperature into lighter weight molecular products that burn more readily, providing higher specific impulse and permitting shorter combustor length. An endothermic fuel also acts as a heat sink, cooling the adjacent structure. Like the ramjet, the scramjet is rocket boosted to a supersonic takeover speed. Takeover speed of a scramjet is higher than a ramjet, about Mach 4.5, requiring a larger booster. For a weight-limited system, a hypersonic scramjet missile will have less available fuel than a supersonic ramjet missile.

Referring again to Figure 9, note that the maximum specific impulse of ducted rocket propulsion is about 800 seconds, intermediate that of a solid rocket and a liquid fuel ramjet. Ducted rockets are most efficient for a Mach number range from about 2.5-4.0. Ducted rockets have advantages of higher acceleration capability (higher thrust) than liquid fuel ramjets and generally have longer range capability (higher specific impulse) than solid rockets. A ducted rocket is particularly suited for the suppression of long range, high performance SAMs. The acceleration and fast response to Mach 3+ provides a short response time for an anti-SAM engagement. Ducted rockets utilize a gas generator to provide fuel-rich products to the combustor. The gas generator flow rate can be controlled, providing a throttle capability for thrust magnitude control. Air from the inlet mixes with the fuel-rich products from the gas generator, providing additional burning. The relatively high acceleration capability of the ducted rocket is due to the momentum of the gases from the gas generator. A disadvantage of the ducted rocket is lower specific impulse than a liquid fuel ramjet. Because the gas generator includes an oxidizer, the total energy stored in the gas generator is less than that of a ramjet or scramjet fuel tank of the same volume. In addition to a relatively high thrust capability of a ducted rocket compared to a ramjet or scramjet, a solid ducted rocket has advantages of lower maintenance requirements and better shipboard compatibility than a ramjet or scramjet.

Figure 10 shows a history of the state-of-the-art advancement for supersonic/hypersonic air breathing missiles over the last fifty years. A number of liquid fuel ramjet demonstrations have been conducted over the years. As shown in the figure, the cruise Mach number demonstrations have provided higher confidence in the capability for efficient hypersonic cruise. Ramjets have demonstrated supersonic and hypersonic cruise up to Mach 4.5. A future flight demonstration of a scramjet plans to demonstrate Mach 6.5 cruise in the year 2004 time frame.

**High Temperature Combustors.** Higher combustion temperature has payoff in improving the specific impulse and thrust of ramjet missiles, enabling flight at higher Mach number. Figure 11 shows the ideal combustion temperature for maximum specific impulse and thrust of an ideal ramjet as a function of Mach number. Results are based on an assumption of isentropic flow and nozzle expansion to atmospheric pressure. As an example, assume that a ramjet baseline missile is operating at 80,000 feet altitude with a combustion temperature of 4,000 degrees Rankine and a fuel-to-air ratio of 0.02. The ratio of the combustion temperature to the free stream temperature is 10.2 and the ratio of specific heat is 1.29. As shown in the figure, for a combustion temperature of 4,000 degrees Rankine, maximum specific impulse for a ramjet is produced at a Mach number of about 4.2. Also shown is the Mach number for maximum thrust per unit frontal area. The maximum thrust per unit frontal area for a combustion temperature of 4,000 degrees Rankine is produced at a Mach number of about 4.5. Improvement in the technology for maximum allowable temperature of insulated combustor materials allows ramjets to operate at higher Mach number. Also shown in the figure are examples of the ideal Mach number at a specific heat ratio of  $\gamma = 1.4$ , corresponding to a low value of the combustion temperature. The ideal Mach numbers are lower for a low combustion temperature with  $\gamma \approx 1.4$ .

**Low Drag Ramjet Inlets.** Examples of low drag inlet alternatives for ramjets are shown in Figure 12. Current operational ramjets have either a nose inlet (United Kingdom Sea Dart) or aft axisymmetric inlets (France ANS and ASMP, Russia AS-17/Kh-31, Kh-41, SS-N-22/3M80, and SA-6). A nose inlet has an advantage of lower drag, while aft axisymmetric inlets have advantages of lighter weight, lower volume, and they do not shroud/degrade warhead effectiveness.

**Ramjet Inlet/Airframe Integration.** Because ramjet combustion is subsonic, there must be a normal shock in the inlet to provide subsonic flow into the combustor. Small oblique shocks prior to the normal shock alleviate the problem of total (stagnation) pressure loss across the normal shock. Figure 13 compares a single,



normal shock total pressure recovery with that of one, two, and three oblique shocks prior to the normal shock. Note that three oblique shocks prior to the normal shock provide a relatively high stagnation pressure recovery. Ramjet inlet/airframe integration through external forebody compression (such as a chin inlet), an optimized inlet cowl lip angle, and internal turning provide higher specific impulse and higher thrust. At hypersonic Mach number a mixed compression inlet (external compression from oblique shock(s) on the forebody, followed by internal oblique shock(s) inside the inlet) is often required. A mixed compression inlet may be desirable to avoid excessive flow turning away from the axial direction. An example is shown of a chin inlet ramjet, which has mixed compression consisting of three oblique shocks. There are two external oblique shocks (from a conical forebody half angle of 17.7 degrees and an inlet ramp angle of 8.36 degrees) plus an internal oblique shock of 8.24 degrees. As shown in the example, the stagnation pressure recovery ratio at Mach 3.5 is 83 percent if there are three oblique shocks. This stagnation pressure recovery is much higher than that for the case of one oblique shock prior to the normal shock or for the case of a single normal shock. Ramjet inlet/airframe integration through forebody compression (such as a chin inlet) and an optimized inlet cowl lip angle provides higher specific impulse and higher thrust.

**High Density Fuels.** Another area of new propulsion advancement is that of higher density fuel. Higher density fuels provide high volumetric performance for volume limited missiles (Figure 14). Current fuels for turbines such as JP-5, JP-7, and JP-10 have relatively low density, of the order of 0.028 pounds per cubic inch, and low volumetric performance, of the order of 559 BTU per cubic inch. Liquid fuel ramjet hydrocarbon fuels such as RJ-4, RJ-5, RJ-6, and RJ-7 have somewhat higher density and higher volumetric performance. Slurry fuels, such as JP-10 with carbon slurry, and solid hydrocarbon fuels have much higher volumetric performance, at the expense of somewhat higher visual observables. Even better performance is achievable with high density, solid metal fuels such as magnesium, aluminum, and boron. For example, solid boron fuel, with a theoretical solids loading of 100%, would provide over three times the volumetric performance of a liquid hydrocarbon fuel. However, disadvantages of solid metal fuels are high visual observables from their plumes and reduced volumetric efficiency from the hollow center grain core that is required for the inlet airflow.

**Rocket Motor Thrust Magnitude Control.** An approach to energy management for a solid rocket is thrust magnitude control. Alternatives include pulsed and pintle motors (Figure 15). The solid pulsed motor uses thermal or mechanical barriers to separate two or more pulses. The time delay between pulses can be controlled to optimize the flight trajectory profile. As a result, a boost-coast-boost-coast pulsed motor can have longer range and reduced aerodynamic heating compared to conventional single burn boost-coast or boost-sustain-coast motors. The second approach to thrust magnitude control, a solid pintle motor, has a pintle plug that is moved in and out of the throat area. Moving the pintle into the throat area provides increased chamber pressure and higher thrust, while moving the pintle out of the throat area decreases the chamber pressure and thrust. Pintle motors have demonstrated maximum-to-minimum thrust ratios of up to ten-to-one. However, larger thrust ratio is at the expense of reduced specific impulse. A third potential alternative for thrust magnitude control is a gel propellant motor. Gel propellants have not yet been accepted for tactical missile applications, particularly for naval platforms, due to concerns of toxicity.

**High Thrust Motor and Reaction Jet Control.** Photographs of the US Army Line-of-Sight Anti-Tank (LOSAT) kinetic kill precision missile are shown in Figure 16. Shown are launches from the Bradley Infantry Fighting Vehicle (IFV) and the High Mobility Multipurpose Wheeled Vehicle (HMMWV). LOSAT has no warhead charge - the kinetic energy of the hypersonic missile provides the kill mechanism. LOSAT provides kinetic energy on target that exceeds that of a tank round, without requiring the heavy weight of a tank gun. It is particularly suitable for rapidly deployed, light forces. The LOSAT system can be deployed using a C-130 aircraft, while an M-1 tank cannot be carried on a C-130 aircraft. Aeromechanics technologies include high thrust motor and reaction jet control. Rapid acceleration to hypersonic speed is provided by a high thrust motor, which has rapid burn propellant. Hit-to-kill accuracy is provided by the launch platform projecting a narrow beam laser spot on the target, laser beam rider guidance, and reaction jet control.

## Missile Airframe Materials Technologies

The assessment of missile airframe materials technologies addresses five new enabling technologies. These are hypersonic structure materials, composite structure materials, hypersonic insulation materials, multi-spectral domes, and reduced parts count structure.

**Hypersonic Structure Materials.** Examples of structure materials that are cost effective for precision strike missiles are shown in Figure 17. The materials are based on consideration of weight, cost, and maximum temperature capability. Composite materials are a new technology that will find increased use in new missile airframe structure. High temperature composites have particular benefits for hypersonic missiles, providing weight reduction. Titanium alloy technology also enables lighter weight missiles in a hypersonic, high temperature flight environment.

As shown in the figure, at subsonic and low supersonic Mach number, graphite epoxy and aluminum or aluminum alloys are attractive choices for lighter weight structure. Graphite epoxy and aluminum alloys have high strength-to-weight ratio, are easily fabricated, have good corrosion resistance, and are low in cost. For higher Mach number, graphite polyimide composite structure has an advantage of high structure efficiency at higher temperature for short duration flight Mach numbers to about Mach 4. For flight at about Mach 4.5, without external insulation, titanium structure and its alloys are preferred. A disadvantage of a titanium structure is higher material and machining cost. However, the cost to cast a part made of titanium is comparable to the cost to cast an aluminum part. At Mach 5, although it is heavy, a steel structure would probably be used. Up to Mach 5.7 without external insulation (about 2,000 degrees Fahrenheit), super nickel alloys such as Inconel, Rene, Hastelloy, and Haynes must be used. Above Mach 5.7 the super alloys require either external insulation or active cooling. The Mach number and temperature application relationships are somewhat dependent upon the temperature recovery factor. At a stagnation region, such as the nose or leading edges, the recovery factor is about 1, resulting in the highest (stagnation) temperature. A turbulent or laminar boundary layer downstream of the nose or leading edge will have temperature recovery factors of about 0.9 and 0.8 respectively, with local temperatures less than stagnation.

**Composite Structure Materials.** The strength-to-weight capability of advanced composites is very high. For example, as shown in Figure 18, the unidirectional tensile strength of a small diameter graphite (carbon) fiber is more than 400,000 pounds per square inch. In addition to small diameter fibers, advanced composite structures have long, continuous fibers and a fiber/matrix ratio that is greater than 50% fibers by volume. Fibers can be graphite (carbon), kevlar, glass, boron, ceramic, silicon carbide, quartz, polyethylene, and others. As an example of strength at the structure level, 50% volume graphite composite structure can have a strength in a tailored laminate that is above 200,000 pounds per square inch, much greater than that of aluminum, or even steel. Also the low density of composites further reduces the weight compared to metals. Graphite fiber composite materials have extremely high modulus of elasticity, resulting in low strain and deflection compared to metals. However, a note of caution, unlike metals that generally yield gracefully before ultimate failure, composite fibers generally fail suddenly without yield.

Figure 19 shows the structural efficiency advantage of composites compared to conventional materials. For short duration temperatures up to about 400 degrees Fahrenheit, graphite epoxy is a good candidate material, based on its characteristics of high strength and low density. Graphite polyimide can be used at even higher temperatures, up to about 1,100 degrees Fahrenheit short duration temperature. Above 1,100 degrees Fahrenheit, titanium and steel are the best materials based on strength-to-weight ratio.

**Hypersonic Insulation Materials.** An area of enabling capability for hypersonic precision strike missiles is short duration insulation technology. Because hypersonic precision strike missiles have stringent volume and weight constraints, higher density external airframe and internal insulation materials are in development. Higher density insulation materials permit more fuel/propellant, resulting in longer range. Thermal insulators are used to provide short duration protection of structural materials from either the aerodynamic heating of a hypersonic free stream or from propulsion heating of the combustion chamber and exhaust gases of the nozzle. Figure 20 shows the maximum temperature and short duration insulation efficiency of candidate insulation materials.

Note that composite materials are good candidates for lighter weight insulation. For high-speed precision strike missiles, medium density plastic composites, such as fiberglass reinforced phenolic resins containing nylon, silica, graphite, or carbon are often used. These have good resistance to erosion, allow high surface temperatures (over 5,000 degrees Rankine) and exhibit good insulation performance. Medium density plastic composite materials char at high temperature, but generally maintain their thickness and aerodynamic shape. They are usually fabricated by wrapping fiberglass tape over a metal form mandrel, so that the grain of the finished unit is oriented for minimum erosion. Cross flow orientation, or other grain directional orientation, is optimized to minimize the amount of the material that is required. After winding, the tape is cured, machined as necessary, and assembled with other components using adhesives and sealants. Another example of a good insulator at somewhat lower temperatures is lower density composites. Lower density composites such as quartz beads/paint, glass cork epoxy or silicone rubber may be used for temperatures up to about 3,000 degrees Rankine. Quartz beads/paint is a spray-on insulation of about 0.015 inch per coat. A third approach based on lower density plastics is rarely used for hypersonic missiles. A disadvantage of low density plastics is that at high temperatures they decompose into gases and sublime, resulting in decreased thickness and changes in the aerodynamic shape. Lower density plastics are also relatively soft, requiring periodic maintenance touch-up.

Ceramic refractory materials and graphite materials are also candidate insulators for high speed airframes, engines, and motor cases. Although ceramic refractory materials and graphites have high temperature capability, the insulation efficiency for a given weight of material is not as good as that of plastic composite materials. An example of a porous ceramic, with a maximum temperature up to about 3,500 degrees Rankine, is resin impregnated carbon-silicon carbide. At high temperatures the resin melts, providing cooling for the structure. Examples of bulk ceramics are zirconium ceramic and hafnium ceramic. Bulk ceramics are capable of withstanding temperatures up to 5,000 degrees Rankine, but like porous ceramics, they have relatively poor insulation efficiency. Finally, graphite insulators provide the highest temperature capability. Graphites are capable of withstanding temperatures greater than 5,000 degrees Rankine. However, graphites have relatively poor insulation efficiency.

Airframe structure/insulation trades include hot structure/internal insulation versus external insulation/“cold” structure versus a one-piece self-insulating composite structure. A consideration for a volume-limited missile is the total thickness of the airframe/insulation. Large thickness means less volume for fuel, resulting in less range.

**Multi-spectral Domes.** Shown in Figure 21 is a comparison of alternative dome materials for missile seekers. The dome materials are grouped based on their best applicability to multi-mode (RF/IR), RF-only, and mid-wave IR-only seekers. Measures of merit are dielectric constant, combined mid-wave/long wave infrared bandpass, transverse strength, thermal expansion, erosion resistance, and maximum short duration temperature. Dome materials that are especially suited for combined radar and infrared seekers are zinc sulfide and zinc selenide. Zinc sulfide has advantages in dielectric constant, transverse strength, and rain erosion. Zinc sulfide is generally the multi-mode dome material of choice for Mach numbers up to 3. For Mach number greater than 3, new materials are required for multi-mode seekers. Candidate materials include spinel/sapphire, quartz/fused silicon, and silicon nitride. These materials are more expensive than zinc sulfide and zinc selenide. A new candidate dome material that is under development for missile defense applications is diamond. Obviously cost is very high for a diamond dome. In addition to high material cost, diamond dome assembly cost is high. Diamond domes must be assembled as a built-up mosaic because the present manufacturing processes produce relatively small size diamonds.

For RF-only seekers, two popular radome materials are pyroceram and polyimide. Pyroceram is commonly used in supersonic missiles. Polyimide radomes are used on relatively low speed, low cost missiles such as the millimeter wave (mmW) Brimstone. Polyimide radomes have excellent dielectric characteristics. For MWIR-only seekers, additional dome materials include magnesium fluoride and Alon. Although both are suitable for supersonic missiles, Alon is less susceptible to rain and dust erosion and is capable of operating at higher Mach number. Multi-spectral dome materials may also be used for MWIR-only and RF-only seekers. Zinc sulfide is suitable for MWIR seekers at supersonic Mach number. Spinel or sapphire domes may be used

with MWIR seekers at high supersonic/low hypersonic Mach numbers. Silicon nitride is suitable for RF and mmW seekers at low hypersonic Mach number.

**Reduced Parts Count Structure.** Airframe cost and producibility are important considerations for precision strike missiles. New airframe technology is in development that will reduce the cost of precision strike weapons. Examples of recent precision strike weapons that include low cost technologies include JDAM and JASSM. Technologies to reduce cost are also being introduced into existing weapons, with large savings. An example is Tactical Tomahawk. It has a simple low cost airframe with extruded wings. It also uses low cost commercial parts for G&C and propulsion. The current Tomahawk has 11,500 parts, 2,500 fasteners, 45 circuit cards, 160 connectors, and requires 610 assembly/test hours. Tactical Tomahawk will have 35% fewer parts, 68% fewer fasteners, 51% fewer circuit cards, 72% fewer connectors, and 68% fewer assembly/test hours – resulting in a 50% reduction in cost (Figure 22). Tactical Tomahawk also has superior flexibility (e.g., shorter mission planning time, capability for in-flight targeting, capability for battle damage indication/battle damage assessment, modular payload) and higher reliability at the same launch weight as the current Tomahawk.

Examples of manufacturing processes that reduce the parts count include vacuum assisted resin transfer molding (RTM), filament winding, pultrusion, casting, vacuum bag/autoclave forming, metal forming, strip laminate, and compression molding. Examples of low cost manufacturing process that are particularly applicable to complex shapes are precision casting, vacuum assisted RTM, filament winding, and pultrusion. Precision casting is particularly suitable. It has high payoff for reducing the cost of high temperature metal airframes with complex shape. A historical limitation in applying castings to complex configurations is the tight manufacturing tolerances required for the complex configurations. However, new technology such as ceramic tooling allows low cost precision castings suitable for complex airframe configurations such as ramjets. Castings reduce the parts count, with a resulting cost savings. Large precision cast structures are in development for complex missile shapes, such as ramjets. A one-piece cast airframe design integrates all of the secondary structure to minimize parts count. Precision casting minimizes subsequent machine and hand finishing of mating surfaces, by achieving a precision surface finish “as-cast.” Fuel cells can be an integral part of the structure and not require bladders. Structural attachment points (e.g., ejector attachments, payload supports, booster attachments) and self-indexing/aligning features can be integral to the structure. This minimizes or eliminates mating/alignment/assembly tooling and test/inspection requirements. Precision castings have been demonstrated for missile aluminum, titanium, and steel airframes, motor cases, and combustors.

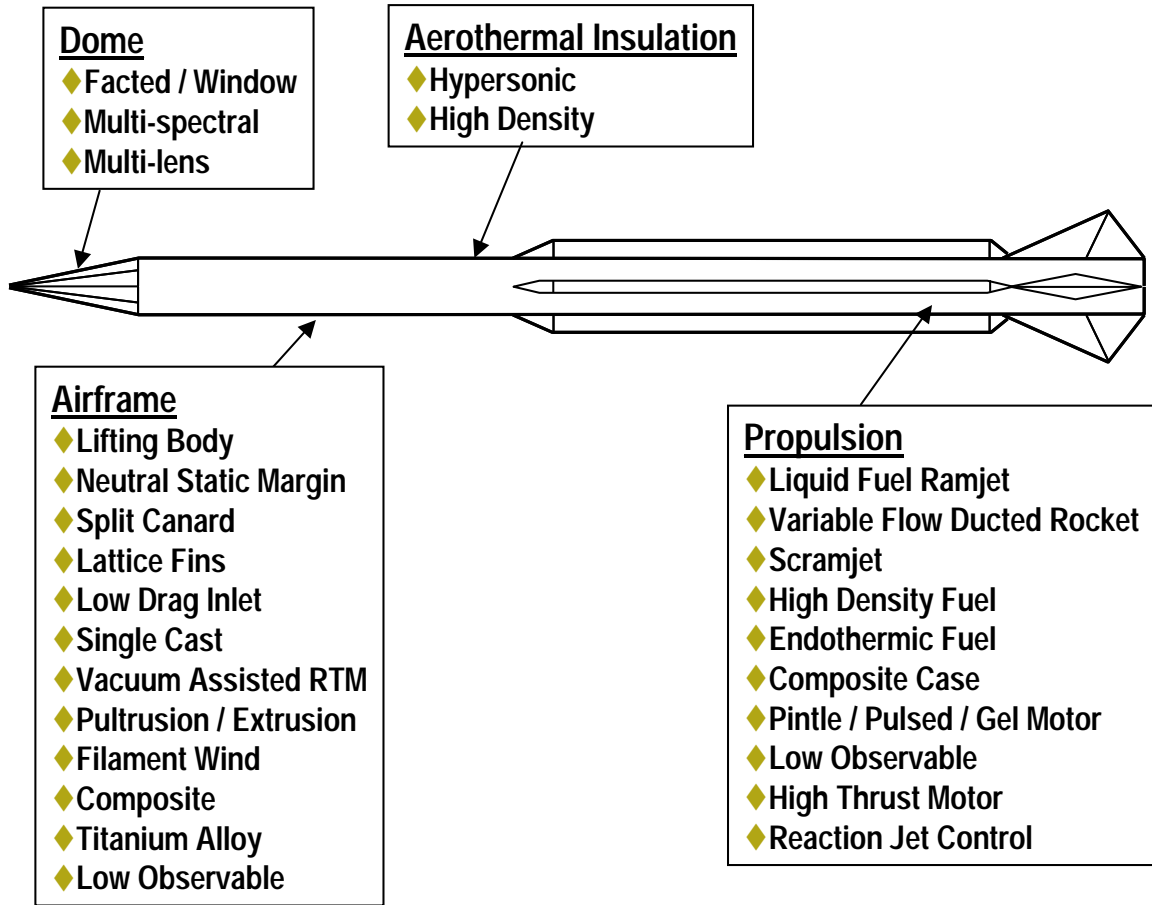

Figure 1. New Aeromechanics Technologies for Precision Strike Missiles.

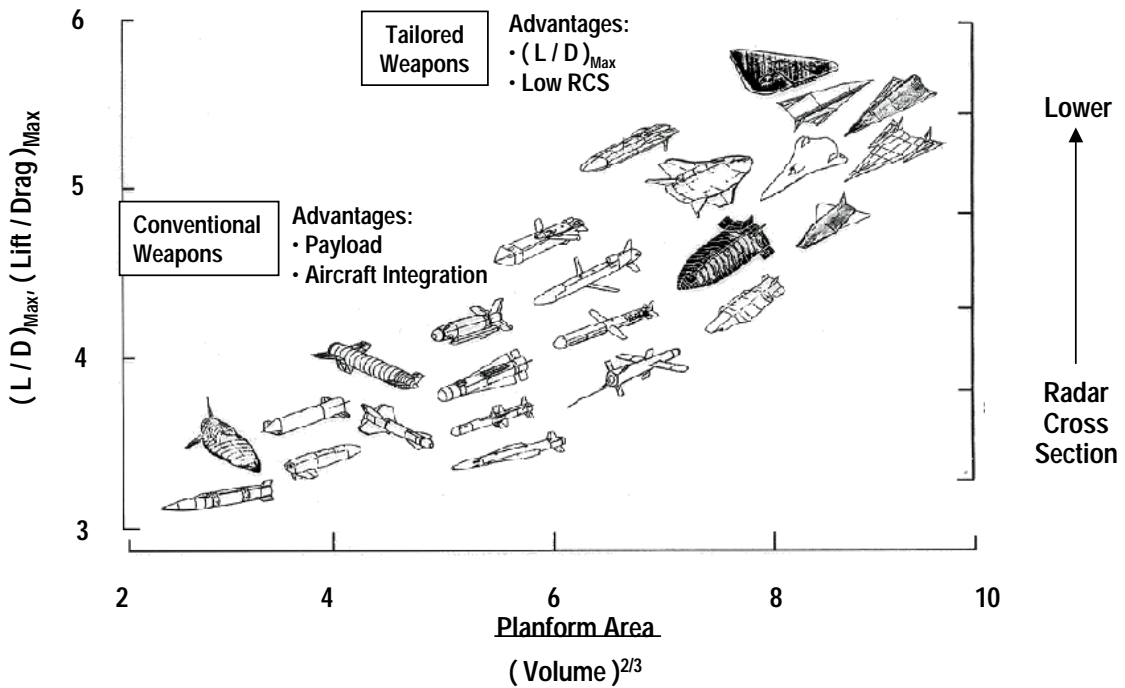

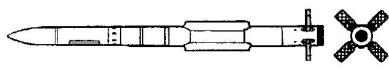

Figure 2. Aerodynamic Shaping Provides Reduced Observables and Higher  $(L/D)_{Max}$ .

Type of Tail Control	Control		Hinge	
	Effectiveness	Drag	Moment	RCS
◆ All Movable ( Example: ASRAAM AIM-132 ) 	●	●	●	●
◆ Flap ( Example: Hellfire AGM-114 ) 	○	●	-	●
◆ Lattice ( Example: Adder AA-12 ) 	●	●	●	-

Note: ● Superior    ● Good    ○ Average    - Poor

Figure 3. Lattice Tail Control Provides High Control Effectiveness and Low Hinge Moment.

◆ Advantages

- ◆ High control effectiveness at low subsonic and high supersonic Mach number
- ◆ Low hinge moment
- ◆ Short chord length

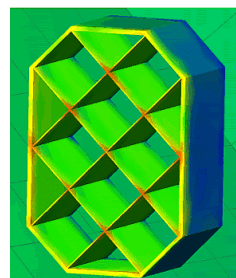

◆ Disadvantages

- ◆ High RCS
- ◆ High drag at transonic Mach number ( choked flow )

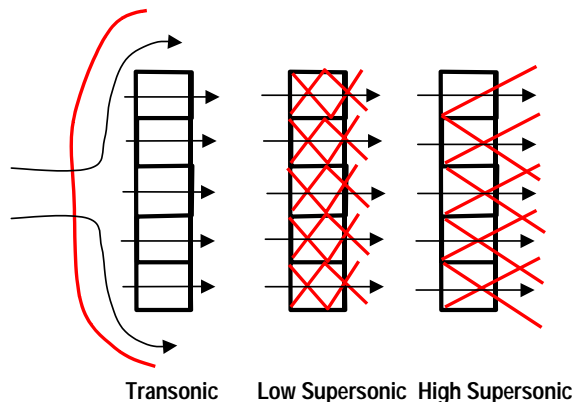
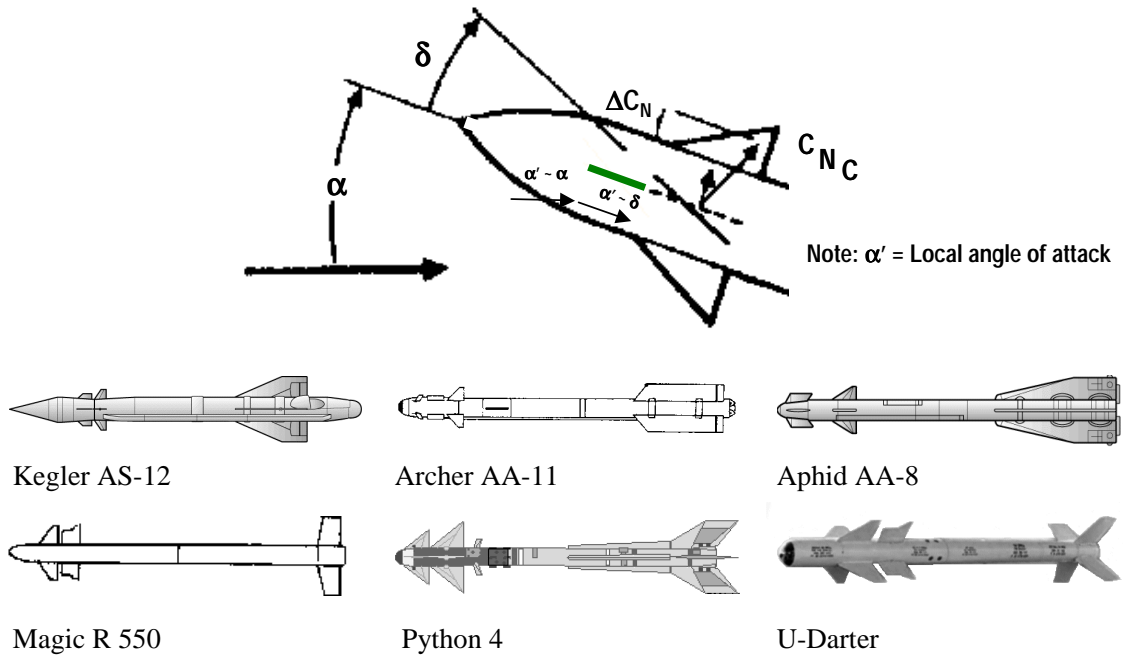

Figure 4. Lattice Fins Have Advantages for Low Subsonic and High Supersonic Missiles.



Note: Forward fixed surface reduces local angle-of-attack for movable canard, providing higher stall angle of attack. Python 4 has free-to-roll tails to alleviate induced roll at high  $\alpha$ .

Figure 5. Split Canards Provide Enhanced Maneuverability at High Angles of Attack.

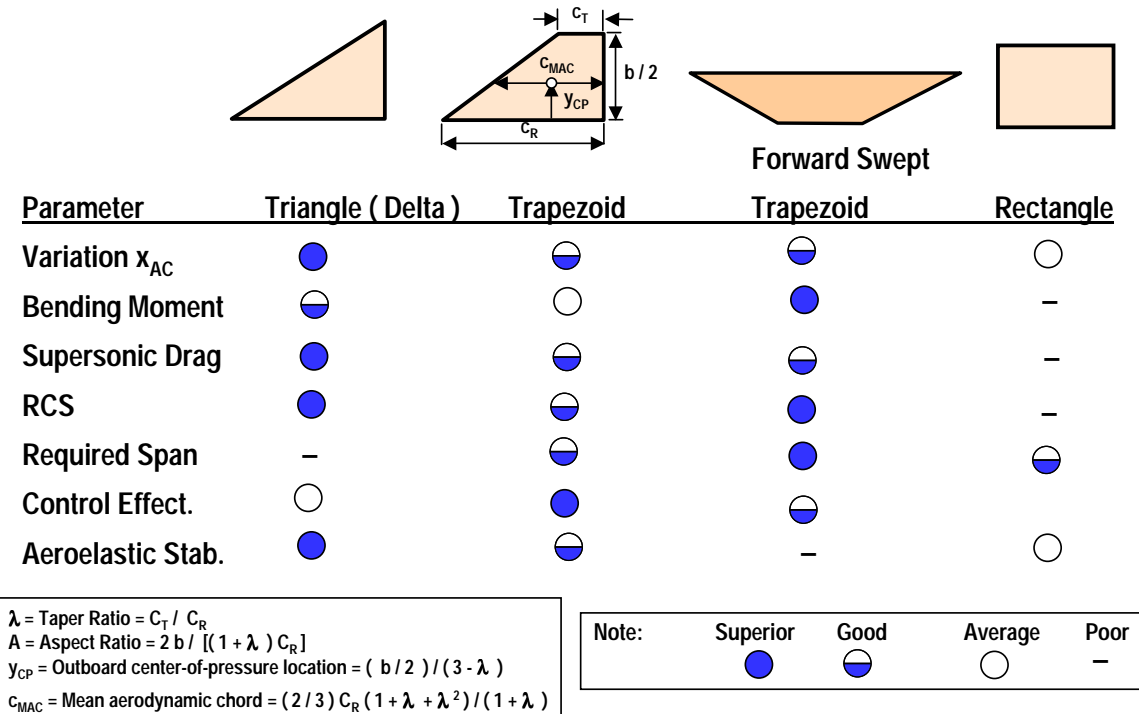

Figure 6. Forward Swept Surfaces Allow Small Span, Have Low RCS, and Have Low Bending Moment.

- ◆ **Skid-To-Turn ( STT )**
  - Advantage: Fast response
  - Features
    - No roll commands from autopilot
    - Works best for axisymmetric cruciform missiles
- ◆ **Bank-To-Turn ( BTT )**
  - Advantage: Provides higher maneuverability for wings, noncircular / lifting bodies, and airbreathers
  - Disadvantages
    - Time to roll
    - Requires fast roll rate
    - May have higher dome error slope
  - Features
    - Roll attitude commands from autopilot
    - Small sideslip
- ◆ **Rolling airframe ( RA )**
  - Advantage: Requires only two sets of gyros / accelerometers / actuators
  - Disadvantages
    - Reduced maneuverability
    - Potential for roll resonance
  - Features
    - Aileron bias / constant roll rate command from auto pilot
    - Can use impulse steering
    - Compensates for thrust offset

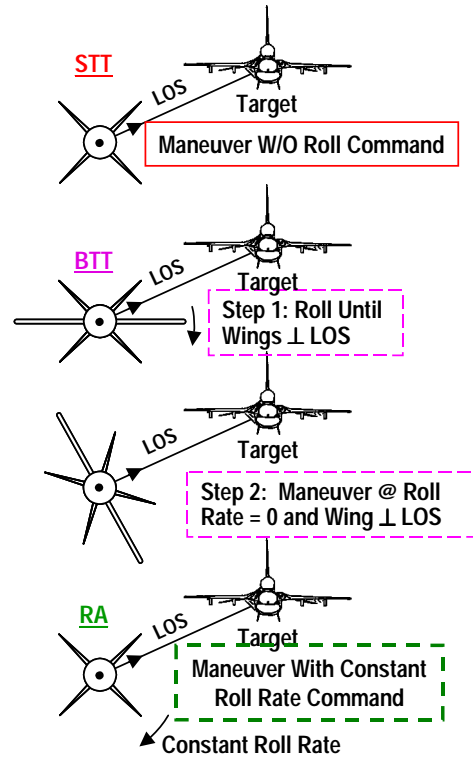
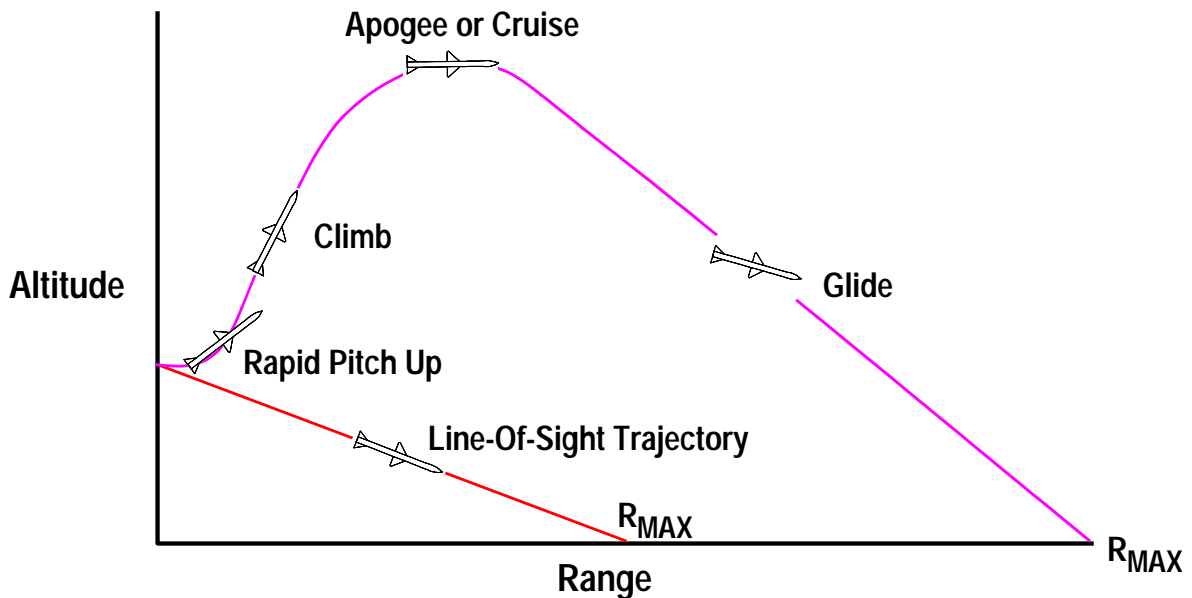

Figure 7. Bank-to-Turn Provides Higher Maneuverability



**Design Guidelines for Horizontal Launch:**

- High thrust-to-weight  $\approx 10$  for safe separation
- Rapid pitch up minimizes time / propellant to reach efficient altitude
- Climb at a  $\approx 0$  deg with thrust-to-weight  $\approx 2$  and  $q \approx 700$  psf minimizes drag / propellant to reach efficient cruise altitude for  $(L/D)_{MAX}$
- High altitude cruise at  $(L/D)_{MAX}$  and  $q \approx 700$  psf to maximizes range
- Glide from high altitude at  $(L/D)_{MAX}$  and  $q \approx 700$  psf provides extended range

Figure 8. Flight Trajectory Shaping Provides Extended Range.



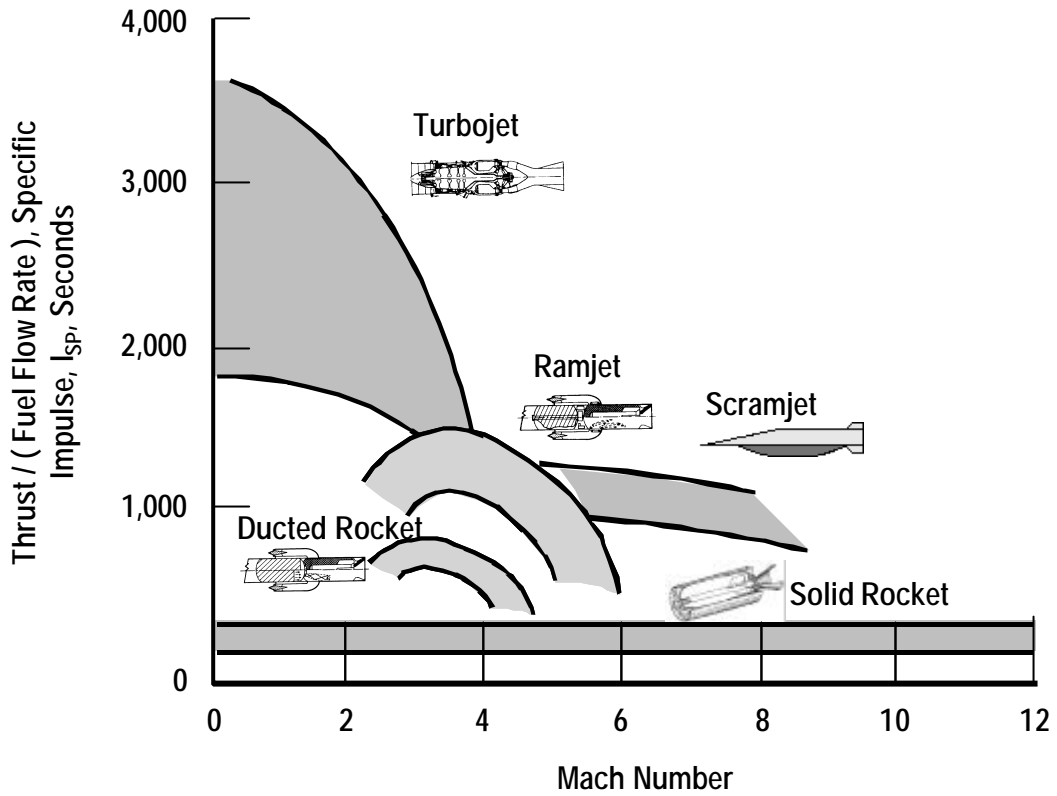

Figure 9. Ramjets and Scramjets Have High Payoff at Supersonic/Hypersonic Mach Number.

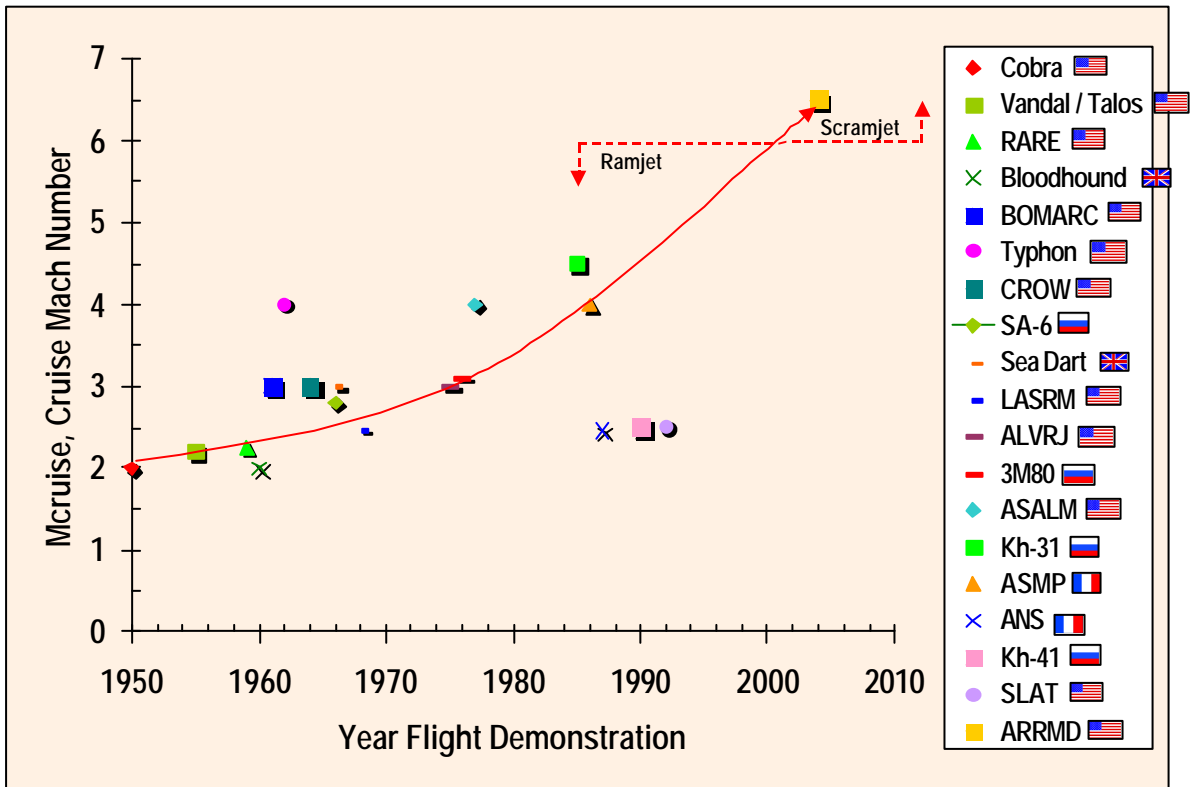

Figure 10. State-of-the-Art Evolution in Supersonic/Hypersonic Air Breathing Missiles.

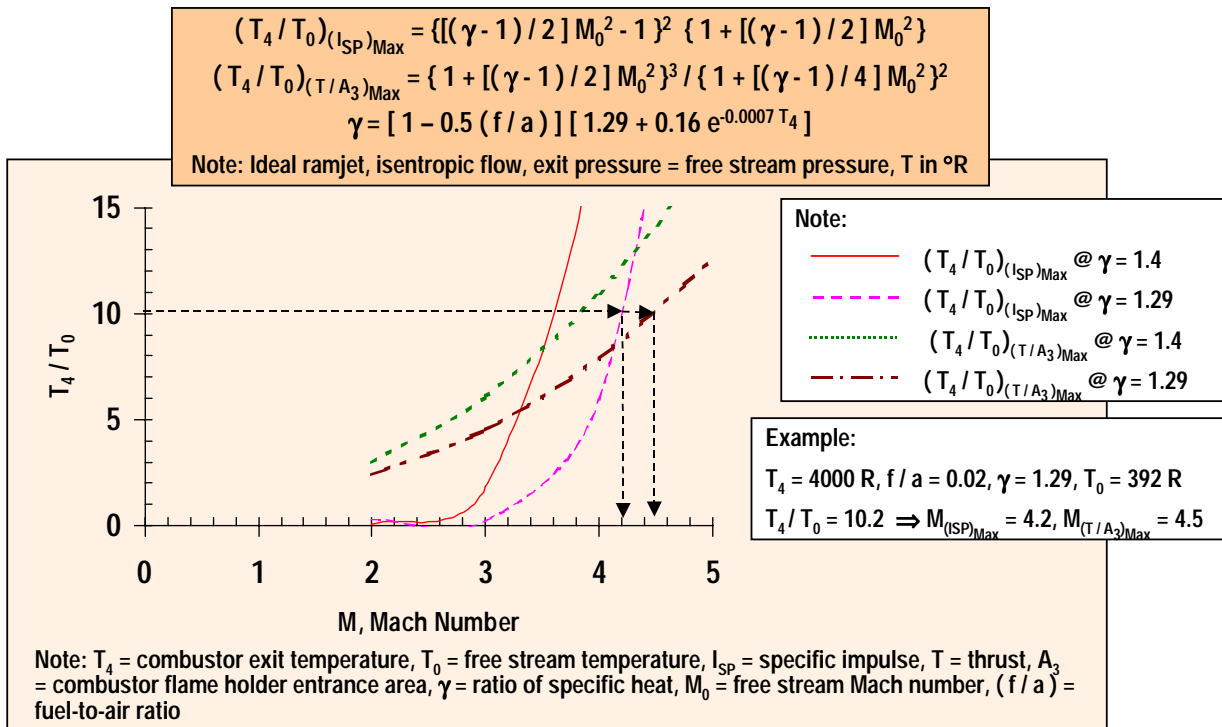
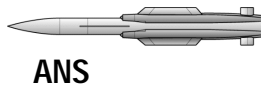

Figure 11. High Combustor Temperature Has High Payoff at Hypersonic Mach Number.

◆ United Kingdom



◆ France



◆ Russia

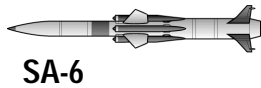
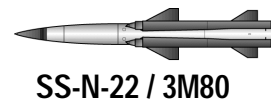
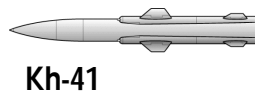
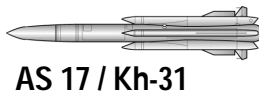

Aft Inlets versus nose inlet:

- ◆ Aft inlets have lower inlet volume and enhanced warhead lethality.
- ◆ Nose Inlet has higher pressure recovery, smaller carriage envelope, and lower drag.

Figure 12. Current Ramjet Inlets Are Either Nose Inlet or Aft Axisymmetric Inlets.

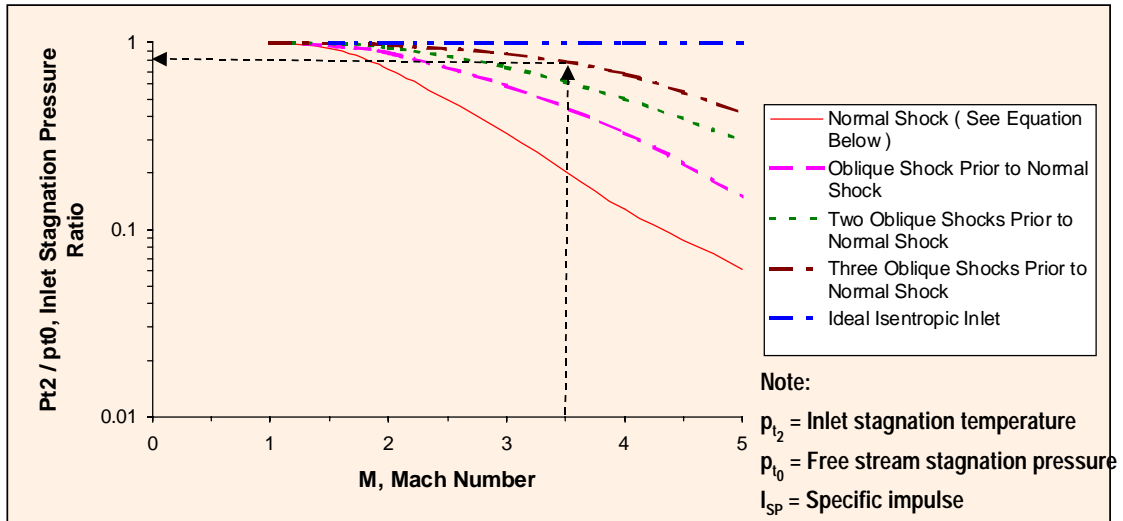

Example for Chin Inlet Ramjet: 

Three oblique shocks ( conical forebody half angle = 17.7 deg, inlet ramp angle = 8.36 deg, internal turning = 8.24 deg )

Mach 3.5,  $p_{t2} / p_{t0} = 0.83$ ,  $I_{SP} = ( p_{t2} / p_{t0} ) I_{SP,PerfectInlet} = 0.83 ( 1457 ) = 1209$  sec

Mach 3.5, 60K ft altitude, stoichiometric thrust,  $T = ( p_{t2} / p_{t0} ) T_{PerfectInlet} = 0.83 ( 4347 ) = 3608$  lb

Note: For Normal Shock Inlet,  $p_{t2} / p_{t0} = \{ \frac{(\gamma + 1) M_0^2}{2 + (\gamma - 1) M_0^2} \}^{\gamma / (\gamma - 1)} / \{ 1 + [ 2 \gamma / (\gamma + 1) ] [ ( M_0^2 - 1 ) ] \}^{1 / (\gamma - 1)}$

Source: Oswatitsch, K., "Pressure Recovery for Missiles with Reaction Propulsion at High Supersonic Speeds", NACA TM - 1140, 1948.

Figure 13. Ramjet Inlet/Airframe Integration Has Payoff.

Type	Volumetric Performance, BTU / in <sup>3</sup>	Low Observables
Turbine ( JP-5, JP-7, JP-10 ), $\rho \sim 0.028$ lb / in <sup>3</sup>	○ 559	●
Liquid Ramjet ( RJ-4, RJ-5, RJ-6, RJ-7 ), $\rho \sim 0.040$ lb / in <sup>3</sup>	○ 581	●
Slurry ( 40% JP-10 / 60% carbon ), $\rho \sim 0.049$ lb / in <sup>3</sup>	◐ 801	○
Solid Hydrocarbon, $\rho \sim 0.075$ lb / in <sup>3</sup>	● 1132	○
Slurry ( 40% JP-10 / 60% aluminum ), $\rho \sim 0.072$ lb / in <sup>3</sup>	◐ 866	-
Slurry ( 40% JP-10 / 60% boron carbide ), $\rho \sim 0.050$ lb / in <sup>3</sup>	● 1191	-
Solid Mg, $\rho \sim 0.068$ lb / in <sup>3</sup>	● 1300	-
Solid Al, $\rho \sim 0.10$ lb / in <sup>3</sup>	● 1300	-
Solid Boron, $\rho \sim 0.082$ lb / in <sup>3</sup>	● 2040	-

● Superior   
 ◐ Above average   
 ○ Average   
 - Below average

Figure 14. High Density Fuels Provide Higher Volumetric Performance.

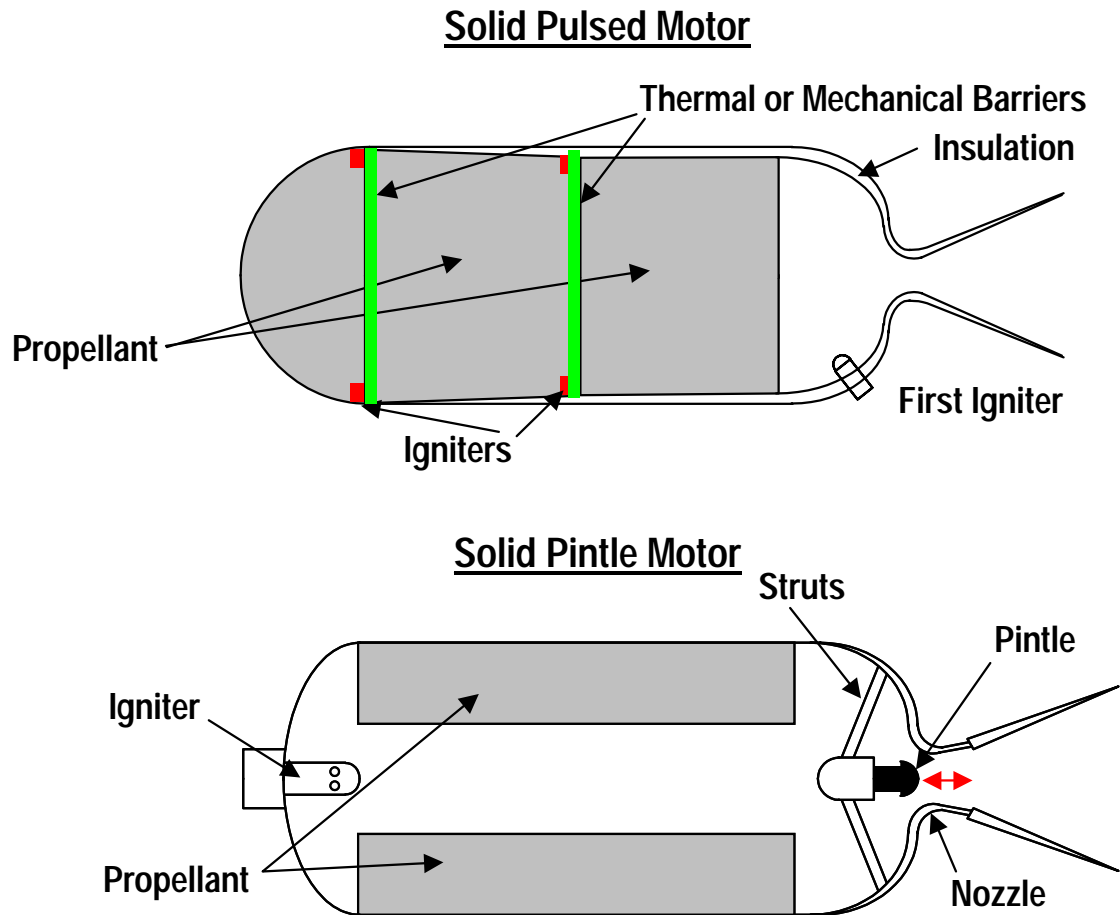

Figure 15. Thrust Magnitude Control Provides Efficient Thrust Management.



LOSAT Launch from Bradley Armored Combat Vehicle



LOSAT Launch from HMMWV



LOSAT Launch from HMMWV



LOSAT Loadout on HMMWV

Figure 16. Enabling Technologies for Hypersonic Precision Strike Kinetic Kill Missiles Include High Acceleration Motor and Reaction Jet Control.

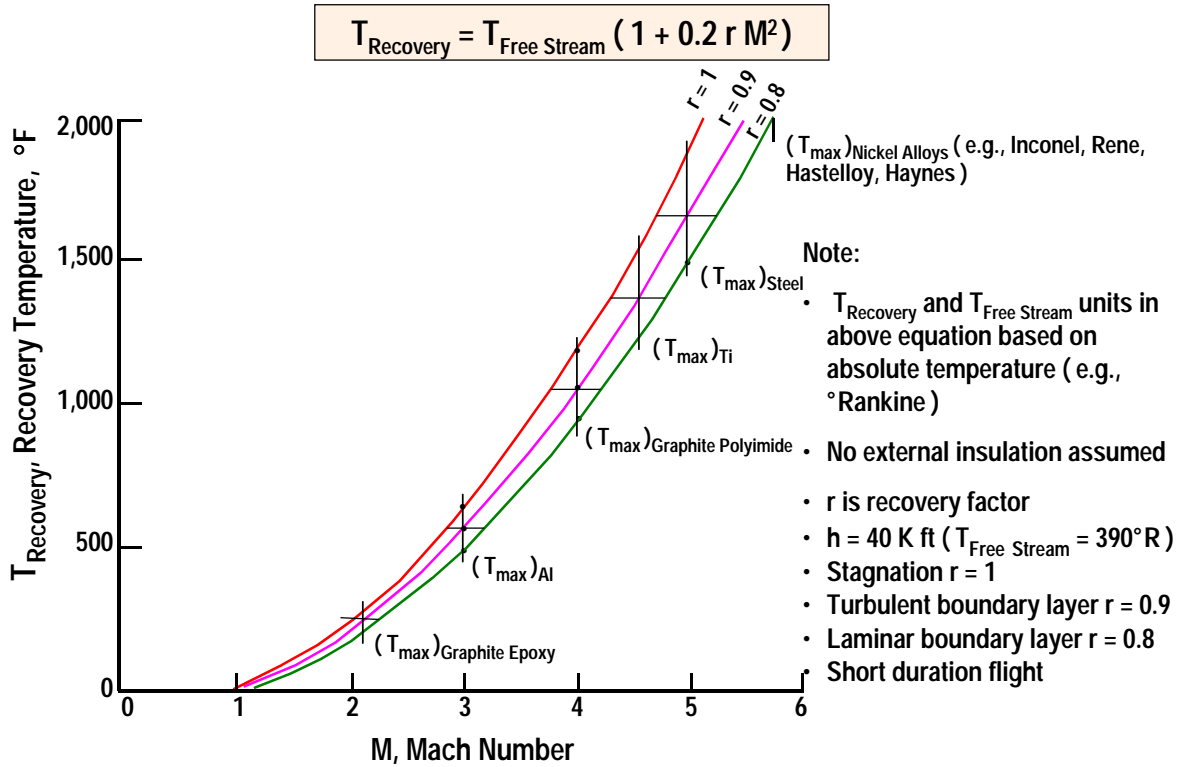

Figure 17. Hypersonic Missiles Require High Temperature Structure.

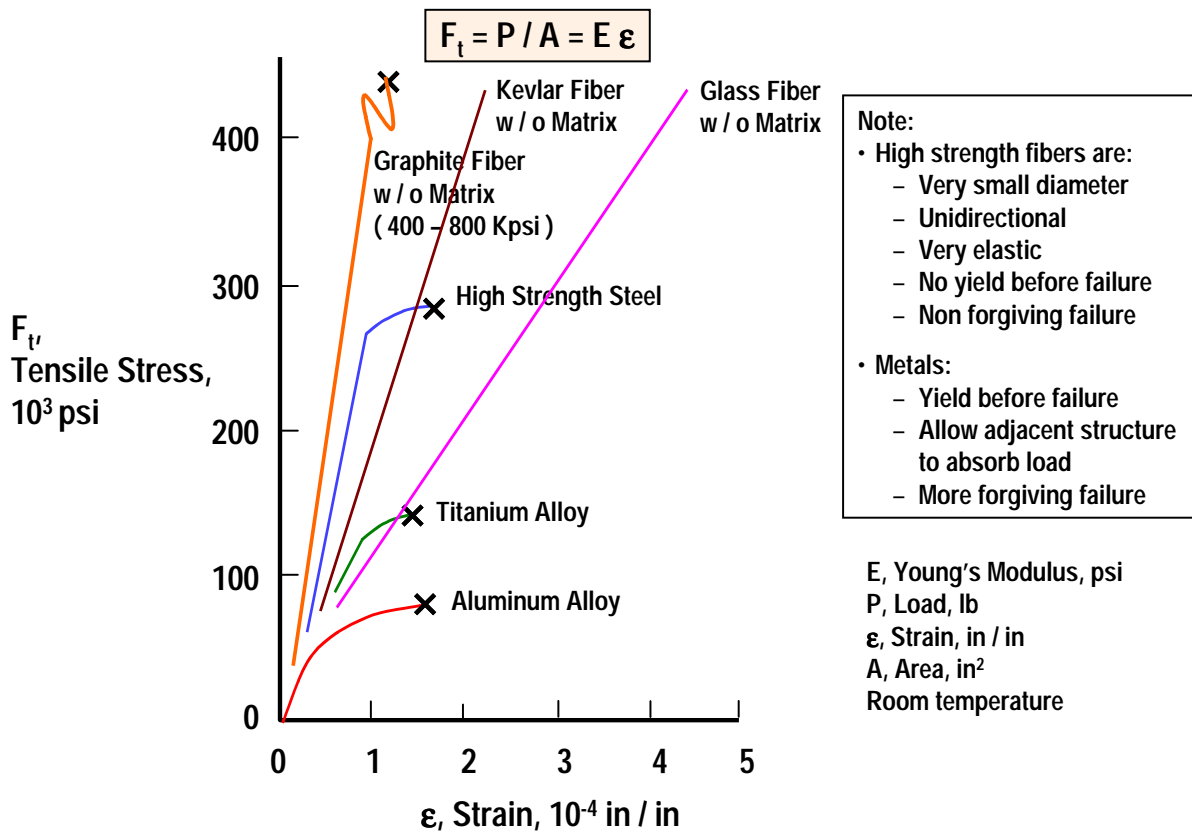

Figure 18. Composites Have High Strength.

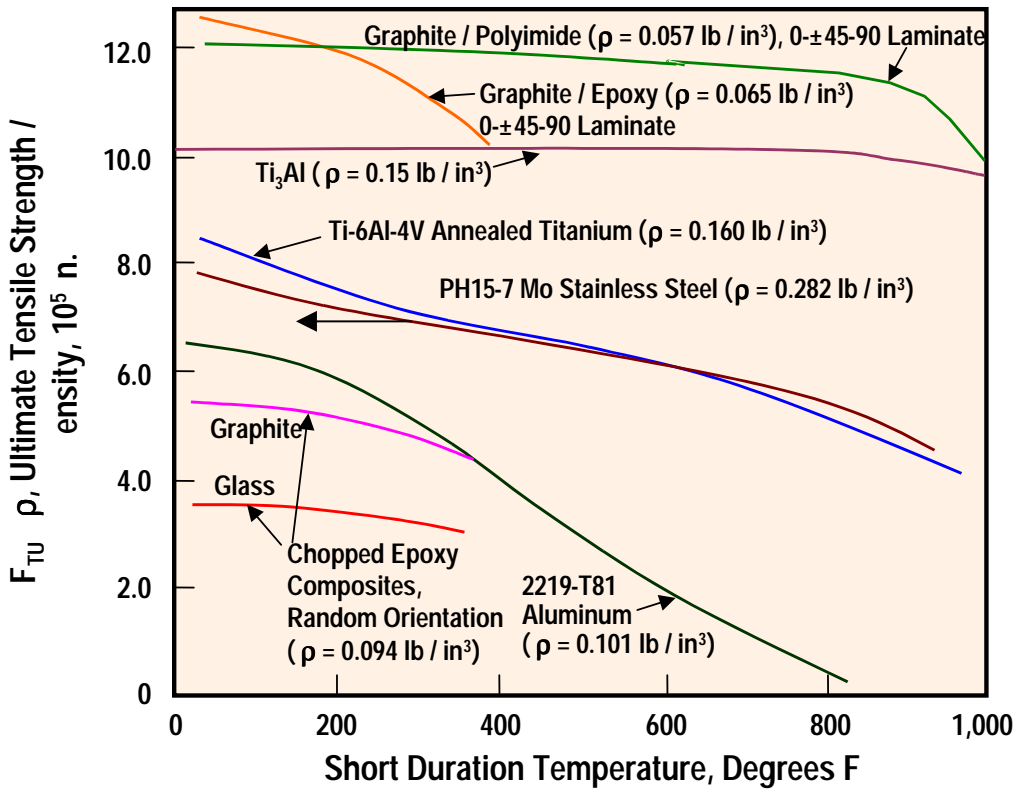
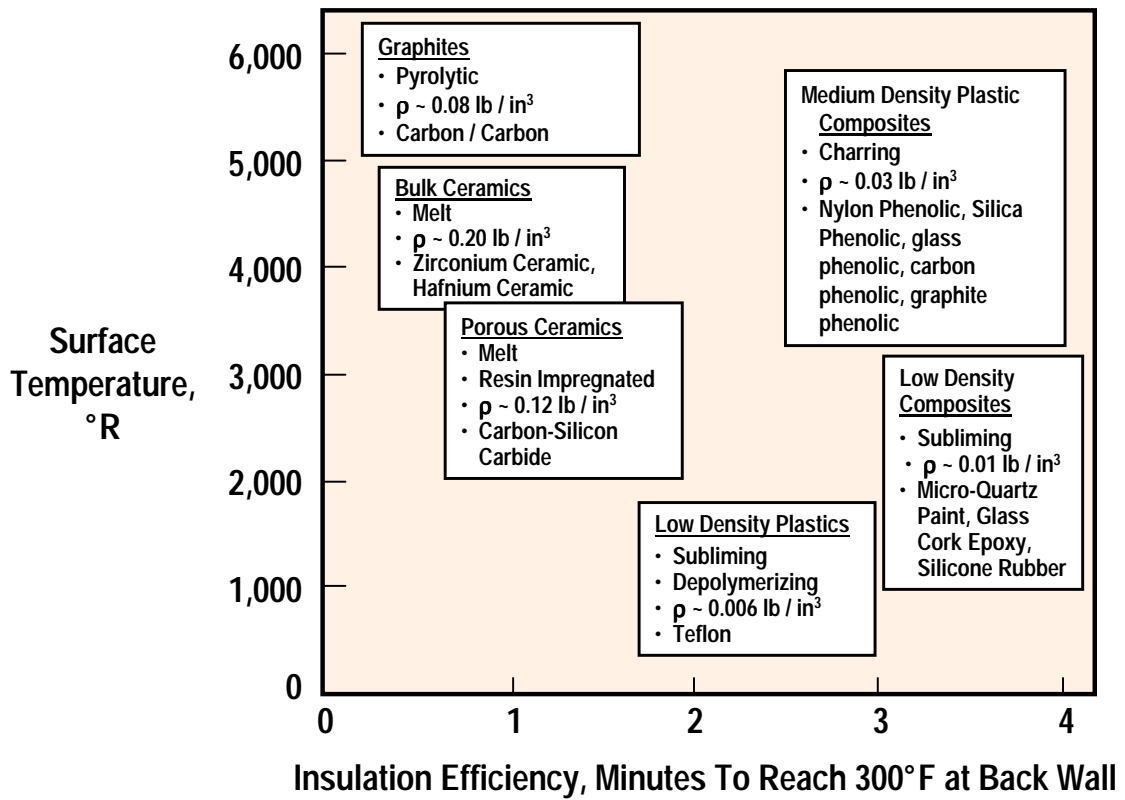

Figure 19. Composites Have High Structural Efficiency.



Note: Assumed Weight Per Unit Area of Insulator / Ablator = 1 lb / ft<sup>2</sup>

Figure 20. Composites Provide Light Weight Insulation.

Seeker Dome Material	Density (gm / cm <sup>3</sup> )	Dielectric Constant	MWIR / LWIR Bandpass	Transverse Strength (psi)	Thermal Expansion (10 <sup>-6</sup> / °F)	Erosion, Knoop (kg / mm <sup>2</sup> )	Max Short-Duration Temp (°F)
<b>RF / IR</b>							
Zinc Sulfide (ZnS)	4.05	○ 8.4	●	○ 18	○ 4	○ 350	○ 700
Zinc Selenide (ZnSe)	5.16	☾ 9.0	●	☾ 8	○ 4	○ 150	○ 600
Spinel (MgAl <sub>2</sub> O <sub>4</sub> )	3.68	○ 8.5	◐	○ 28	○ 3	● 1650	● 1800
Quartz / Fused Silicon (SiO <sub>2</sub> )	2.20	● 3.7	○	☾ 8	● 0.3	◐ 600	● 2000
Silicon Nitride (Si <sub>3</sub> N <sub>4</sub> )	3.18	◐ 6.1	☾	● 90	◐ 2	● 2200	● 2700
Diamond (C)	3.52	◐ 5.6	☾	● 400	● 1	● 8800	● 3500
<b>RF Only</b>							
Pyroceram	2.55	◐ 5.8	☾	○ 25	○ 3	◐ 700	● 2200
Polyimide	1.54	● 3.2	☾	○ 17	☾ 40	☾ 70	☾ 200
<b>MWIR Only</b>							
Mag. Fluoride (MgF <sub>2</sub> )	3.18	◐ 5.5	●	☾ 7	☾ 6	◐ 420	◐ 1000
Alon (Al <sub>23</sub> O <sub>27</sub> N <sub>5</sub> )	3.67	☾ 9.3	◐	◐ 44	○ 3	● 1900	● 1800

● Superior ◐ Above Average ○ Average ☾ Below Average

Figure 21. Broad Bandpass Domes Support Multi-Mode/Multi-Spectral Seekers.

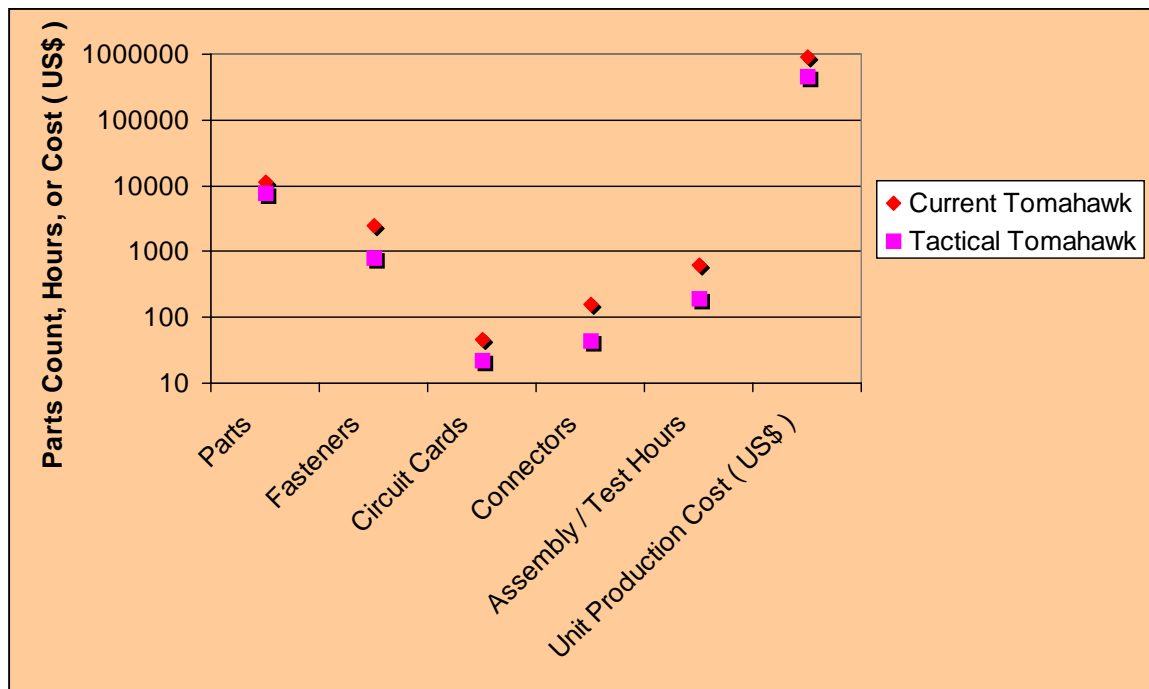

Note: Tactical Tomahawk has superior flexibility (e.g., shorter mission planning, in-flight retargeting, BDI / BDA, modular payload) at lower parts count / cost and higher reliability. Enabling technologies for low parts count include: casting, pultrusion / extrusion, centralized electronics, and COTS.

Figure 22. Low Parts Count Reduces Missile Cost.

**This page has been deliberately left blank**



**Page intentionnellement blanche**



# Guidance and Control Technology

**Erik Berglund**

Swedish Defence Research Agency  
172 90 Stockholm, Sweden  
eberglund@foi.se

## Summary

The fundamental ideas and the basic mathematics of the most common missile guidance laws are outlined. Rules of thumb for the required lateral acceleration for the different guidance laws are given.

A brief summary of flight mechanics is given. The pitch axis control is treated and the dynamic properties are identified. Design of the autopilot for the inner loop using modern methods of controller design is briefly outlined.

## Introduction

Precision guided weapons have played an increasingly important role in recent conflicts and much media attention has been focused on the surgical precision provided by modern high-tech weapons. However, the concepts behind today's guided weapons date back to the Second World War and in some cases even to the First World War. It is, however, clear that the technological progress has only recently made it possible to fully exploit the concept of guided weapons.

*Guidance* can be defined as the strategy for how to steer the missile to intercept, while *control* can be defined as the tactics of using the missile control actuators to implement the strategy.

Guidance has normally been divided into:

- Target related guidance, where target tracking data are provided in real time from a sensor, which can be on-board or off-board.
- Non-target related guidance, where the missile navigates to some predetermined point, which can be the target or the point where target related guidance can begin.

As the integration sensor-to-shooter improves and near real time targeting data can be obtained from sensors not tied to the missile system, this distinction becomes less clear. It must also be noted that the performance of affordable navigational systems (integrated GPS/INS) offers precision in the order of meters. Weapons using non-target related guidance, such as JDAM, can hence compete with traditional homing missiles.

## Mid-course guidance and trajectory optimisation

A case of partially target related guidance is mid-course guidance, where the missile is guided to the vicinity of the target using target data from an external sensor. Most long range weapons designed against mobile targets employ mid-course guidance. Examples of this are air-to-air missiles such as AMRAAM.

Air-to-air missiles often employ trajectory optimisation during the mid-course. The main reason for this is to exploit the lower drag at higher altitude. Optimisation can be used to obtain minimal time of flight, maximal range, maximal terminal velocity etc.

Trajectory optimisation can also be used for air-to-surface weapons to obtain a favourable angle of impact, no angle of attack at impact etc. The performance of penetrating warheads can be greatly improved by terminal trajectory optimisation.

A further use for trajectory optimisation can also be route planning, where the missile's flight path is planned to avoid obstacles, maximise survivability, maximise the probability of target acquisition etc. This planning is normally done prior to launch, but re-planning can be done in flight by the missile.

Advances in computational power and optimisation algorithms have now made it possible to use real time optimisation in flight.

## Guidance Laws

The most fundamental, and also most commonly used, guidance laws are:

- Velocity Pursuit
- Proportional Navigation
- Command-to-Line-of-Sight
- Beam Riding

All of these guidance laws date back to the very first guided missiles developed in the 1940's and 1950's. The reasons that they have been so successful are mainly that they are simple to implement and that they give robust performance.

Velocity pursuit is used mainly in the first generations of laser guided bombs, e.g. Paveway I and II. Proportional navigation is used in almost all homing missiles. Command-to-line-of-sight is used in short to medium range missiles without seekers, e.g. most anti-tank missiles and many surface-to-air missiles. Beam-riding is not so common, but it is found in surface-to-air missiles such as RBS70 and ADATS.

The presentation in this paper is mainly based on Assarsson. For further reading on missile guidance there are several good textbooks, e.g. Blakelock, Garnell, Lee, and Zarchan.

## Velocity Pursuit

The conceptual idea behind velocity pursuit guidance is that the missile should always head for the target's current position. Provided that the missile's velocity is greater than the target's, this strategy will result in an intercept.

The required information for velocity pursuit is limited to the bearing to the target, which can be obtained from a simple seeker, and the direction of the missile's velocity. Velocity pursuit is usually implemented in laser guided bombs, where a simple seeker is mounted on a vane, which automatically aligns with the missile's velocity vector relative to the wind. The mission of the guidance and control system thus becomes to steer the bomb such that the target is centred in the seeker.

Using a target fixed polar coordinate system, see figure 1, the equations describing the kinematics of velocity pursuit are

$$\begin{aligned}\dot{r} &= v_T \cdot \cos \phi - v_M \\ r \cdot \dot{\phi} &= -v_T \cdot \sin \phi\end{aligned}$$

Integration gives

$$r = r_0 \cdot \frac{(1 + \cos \phi_0)^{\frac{v_M}{v_T}}}{(\sin \phi_0)^{\frac{v_M}{v_T}}} \cdot \frac{(\sin \phi)^{\frac{v_M}{v_T}-1}}{(1 + \cos \phi)^{\frac{v_M}{v_T}}}$$

where index 0 denotes the initial condition.

An observation from the above equation is that intercept (when  $r$  approaches zero) occurs at either  $\phi=0$  or  $\phi=\pi$ , i.e. tail-chase or head-on. As the head-on case proves to be unstable, the only feasible case is the tail-chase intercept.

The velocity pursuit guidance law results in high demanded lateral acceleration, in most cases infinite at the final phase of the intercept. As the missile cannot perform infinite acceleration, the result is a finite miss distance.

Velocity pursuit is thus sensitive to target velocity and also to disturbances such as wind. The velocity pursuit guidance law is not suitable for meter precision.

## Proportional Navigation

The conceptual idea behind proportional navigation is that the missile should keep a constant bearing to the target at all time. As most sailors know this strategy will result in an eventual impact.

The guidance law that is used to implement this concept is

$$\dot{\gamma} = c \cdot \dot{\phi}$$

where  $\gamma$  is the direction of the missile's velocity vector,  $\phi$  is the bearing missile to target, and  $c$  is a constant. Both of the angles  $\gamma$  and  $\phi$  are measured relative to some fixed reference.

With angles as defined in figure 4 and using polar coordinates the following kinematic equations in the 2D case can be obtained:

$$\begin{aligned} r\dot{\phi} &= v_M \cdot \sin(\phi - \gamma) - v_T \cdot \sin \phi \\ \dot{r} &= -v_M \cdot \cos(\phi - \gamma) + v_T \cdot \cos \phi \\ \dot{\gamma} &= c \cdot \dot{\phi} \end{aligned}$$

A linearised model of the kinematics can be obtained by considering deviations denoted by  $\Delta$  from the ideal collision triangle denoted by index 0.

$$\begin{aligned} \phi &= \phi_0 + \Delta\phi \\ \gamma &= \gamma_0 + \Delta\gamma \\ \gamma_T &= \gamma_{T0} + \Delta\gamma_T \end{aligned}$$

where  $\gamma_T$  is the direction of the target's velocity vector relative to the reference.

The equations for the disturbances thus become:

$$\begin{aligned} \frac{d}{dt}(\Delta\phi \cdot r) &= -v_M \cdot \cos(\phi_0 - \gamma_0) \cdot \Delta\gamma + \\ &+ v_T \cdot \cos(\phi_0 - \gamma_{T0}) \cdot \Delta\gamma_T \\ \dot{r} &= -v_M \cdot \cos(\phi_0 - \gamma_0) + v_T \cdot \cos(\phi_0 - \gamma_{T0}) \approx -v_C \\ \frac{d}{dt}(\Delta\gamma) &= c \cdot \frac{d}{dt}(\Delta\phi) \end{aligned}$$

where the closing velocity  $v_C$  has been introduced.

The time-to-go,  $\tau$ , is introduced as

$$\tau = \frac{r}{v_c}.$$

From the equations can be observed that

$$\dot{\gamma} = -\frac{c \cdot v_M \cdot \cos \phi_0}{\tau \cdot v_c} \cdot \gamma + \dots$$

It can be concluded that the factor

$$\frac{c \cdot v_M \cdot \cos \phi_0}{\tau \cdot v_c}$$

is of significant importance to the performance of the guidance law.

So far the guidance law has been formulated with the rotation of the velocity vector as the variable to be controlled. However, a more natural variable to control is the missile's lateral acceleration. As the closing velocity, which is found in the loop gain above, varies greatly with the geometry of the intercept, altitude, target type etc, it is desirable to include the closing velocity in the guidance law.

Hence

$$n_M = \alpha \cdot v_c \cdot \dot{\phi}$$

The parameter  $\alpha$  is called the navigation constant and should be between 3 and 4 (maybe up to 5) to ensure good dynamic performance. A value of  $\alpha$  greater than 2 is required for the missile to intercept manoeuvring targets.

This formulation requires a measurement or an estimate of the closing velocity. If the missile uses active radar homing, a measurement of the closing velocity can be obtained using Doppler technology. In most other cases a rough estimate can be obtained from the geometry of the engagement and the altitude.

From the equations above an expression for the required missile acceleration to intercept a manoeuvring target can be derived as:

$$\frac{n_M}{n_T} = \frac{\cos \phi_0}{\cos(\phi_0 - \gamma_0)} \cdot \frac{\alpha}{\alpha - 2} \cdot \left[ 1 - \left( \frac{\tau}{\tau_0} \right)^{\alpha - 2} \right]$$

Where  $\tau_0$  has been introduced as the total time of flight and  $n_T$  is the target load factor. In the head on or tail chase scenarios this can be simplified and especially if the endgame, where  $\tau$  approaches zero, is considered, the following expression is obtained:

$$\left| \frac{n_M}{n_T} \right| = \frac{\alpha}{\alpha - 2}$$

As  $\alpha$  normally is between 3 and 4, this rule of thumb gives that a homing missile should be designed to perform three times the target's possible lateral acceleration.

## Augmented Proportional Navigation

The proportional navigation guidance law gives the missile good performance against targets moving with constant velocity. If the target acceleration can be measured, it is possible to augment the PN guidance law by adding a term to compensate for the target acceleration. The Augmented Proportional Navigation (APN) guidance law thus becomes

$$n_M = \alpha \cdot \left( v_c \cdot \dot{\phi} + \frac{1}{2} \cdot n_T \right)$$

For APN the required lateral acceleration of the missile given by a target manoeuvre can be derived as

$$\frac{n_M}{n_T} = \frac{1}{2} \cdot \alpha \left( \frac{\tau}{\tau_0} \right)^{\alpha-2}$$

The maximal acceleration thus becomes

$$\frac{n_M}{n_T} = \frac{1}{2} \cdot \alpha$$

Or, as  $\alpha$  is between 3 and 5, about twice the target load factor. It can furthermore be observed that the maximal acceleration occurs at the initiation of the evasive manoeuvre, while for the PN law it occurs at the more critical final phase of the intercept.

However, before declaring the augmented proportional navigation law as superior to PN, the dynamic performance and the robustness relative to disturbances have to be considered.

The missile is here assumed to be a third order system, i.e.

$$\frac{n_M}{n_c} = \frac{1}{(1+sT) \cdot \left( 1 + \frac{2\zeta s}{\omega} + \frac{s^2}{\omega^2} \right)}$$

with the following numerical values:

$$\begin{aligned} \omega &= 10 \text{ rad / s} \\ \zeta &= 0.7 \\ T &= 0.5 \text{ s} \end{aligned}$$

The missile furthermore has a navigational constant of 3 and the target manoeuvres with a load factor of 3g. Then the miss distance as function of time to go at the initiation of the target manoeuvre and of the accuracy with which the target's acceleration can be estimated is shown in figure 5.

The conclusion from the dynamic analysis of the APN law is that the superior performance relative to PN is clearly sensitive to errors in the estimation of the target manoeuvre. It can also be noted that it is especially bad to over estimate the target acceleration. This sensitivity is certainly a reason for the limitations faced by APN in practical use.

## Command-to-Line-of-Sight and Beam Riding

Both Command-to-Line-of-Sight (CLOS) and Beam Riding (BR) use the same fundamental idea, i.e. that the missile should be on the straight line between the launcher and the target throughout the trajectory. That guidance law can be called line-of-sight guidance or three point guidance.

With terminology according to figure 6 and with  $r_M$  and  $r_T$  the distances from the missile fire unit to the missile and to the target respectively, the equations describing line-of-sight guidance can be expressed in polar coordinates as:

$$\begin{aligned} r_M \cdot \dot{\phi}_M &= -v_M \cdot \sin(\phi_M - \gamma_M) \\ \dot{r}_M &= v_M \cdot \cos(\phi_M - \gamma_M) \end{aligned}$$

If the first equation is derived with respect to the time and divided by the second, the following equation is obtained:

$$\dot{\gamma}_M = \left( 2 - \frac{\dot{v}_M}{v_M} \cdot \frac{r_M}{\dot{r}_M} \right) \cdot \dot{\phi}_M + \frac{r_M}{\dot{r}_M} \cdot \ddot{\phi}_M$$

The equation for the target can be expressed similarly as

$$\dot{\gamma}_T = \left( 2 - \frac{\dot{v}_T}{v_T} \cdot \frac{r_T}{\dot{r}_T} \right) \cdot \dot{\phi}_T + \frac{r_T}{\dot{r}_T} \cdot \ddot{\phi}_T$$

Ideal line-of-sight guidance implies that

$$\phi_M \equiv \phi_T$$

The missile equation can thus be written as

$$\dot{\gamma}_M = \left( 2 - \frac{\dot{v}_M}{v_M} \cdot \frac{r_M}{\dot{r}_M} \right) \cdot \dot{\phi}_T + \frac{r_M}{\dot{r}_M} \cdot \left[ \frac{\dot{r}_T}{r_T} \cdot \dot{\gamma}_T - \left( 2 \frac{\dot{r}_T}{r_T} - \frac{\dot{v}_T}{v_T} \right) \cdot \dot{\phi}_T \right]$$

If

$$\begin{aligned} \dot{v}_T &= 0 \\ \dot{v}_M &= 0 \end{aligned}$$

i.e. constant velocity is assumed for both missile and target, the equation becomes

$$\dot{\gamma}_M = \left( 2 - \frac{r_M}{\dot{r}_M} \cdot \frac{\dot{r}_T}{r_T} \right) \cdot \dot{\phi}_T + \frac{r_M}{\dot{r}_M} \cdot \frac{\dot{r}_T}{r_T} \cdot \dot{\gamma}_T$$

The first term in this equation gives the manoeuvre required for the missile to keep up with the rotation of the line-of-sight, while the second term gives the manoeuvre required to counter a target manoeuvre. An analysis of the second term, using the facts that the missile generally is between the launcher and the target and also generally moving away from the launcher with greater velocity than the target, i.e.

$$\begin{aligned} r_M &< r_T \\ \dot{r}_M &> \dot{r}_T \end{aligned}$$

shows that the manoeuvrability requirement generated by target manoeuvres is less than the target load factor and that it increases closer to intercept. This is in contrast to the manoeuvre requirement for proportional navigation which is about three times the target load factor.

The dominating manoeuvrability requirement on line-of-sight guided missiles is usually not generated by target manoeuvres but by target velocity. The requirement for a short inner limit to the launch zone is often the driving requirement.

The required lateral acceleration can be expressed as

$$n_M = 2 \frac{v_M \cdot v_T}{d} \beta$$

where  $\beta$  is an acceleration factor obtained from the diagram in figure 8.  $d$  is the crossrange, i.e. the minimal perpendicular distance between the target's trajectory and the fire unit, and  $\varphi$  is angle between the line-of-sight and the missile velocity vector.

Both CLOS and BR rely on a tracking sensor in connection to the launcher to track the target continuously during the intercept. In a CLOS system the tracking sensor tracks both the target and the missile and measures the angular difference between the two objects. Control commands are then calculated based on the desire to drive the angular difference between the missile and the target to zero, and these commands are subsequently transmitted to the missile.

In a beamrider system the fire unit projects a beam that continuously tracks the target. This beam can be generated by a laser or by an RF transmitter. The missile has a sensor in its rear, that measures the deviation from the centre of the beam and the missile flight control system seeks to minimise that deviation.

Although the guidance law is the same for CLOS and BR, the former implementation enjoys an advantage as the calculation of the command signals can use more information than just the present deviation from the line-of-sight. The use of the rotation of the line-of-sight as a feed-forward term can significantly decrease the miss distance.

Both CLOS and BR are limited in range, as the target tracking errors, which are the results of angular measurements at the launch site, generate miss distances proportional to the range.

## Characteristics of the Guidance Laws

The characteristics of the treated guidance laws are summarised in the table below.

Guid.law	Acc due to target velocity	Acc due to target acceleration	Required measurement
VP	infinite	infinite	Angle between target bearing and velocity vector
PN	Zero	$3 * n_T$	Rotation of bearing to target
APN	Zero	$2 * n_T$	Rotation of bearing to target and target acceleration
CLOS	High at short range	$< n_T$	Angular deviation from line-of-sight
BR	High at short range	$< n_T$	Angular deviation from line-of-sight

## Control

An autopilot is a function that improves the flight performance of the vehicle by using feed-back of some of the state variables, such as angular velocities and accelerations, obtained from rate gyros and accelerometers respectively.

The mission of the control system in the missile autopilot is to ensure stability, high performance, and that the missile flies in accordance to the demands from the guidance law. The most important objective is to design the control system such that the miss distance is minimised given relevant disturbances such as target evasive manoeuvres, measurement noise, jamming, wind etc.

The missile dynamics to be controlled are given by Newton's equation for a rigid body in 6 degrees of freedom:

$$\sum \mathbf{F} = \frac{d}{dt}(m\mathbf{v})$$

$$\sum \mathbf{M} = \frac{d\mathbf{H}}{dt}$$

Or explicitly as six equations, and with the assumption of constant mass:

$$F_x = m(\dot{u} + wq - vr)$$

$$F_y = m(\dot{v} + ur - wp)$$

$$F_z = m(\dot{w} + vp - uq)$$

$$M_x = \dot{p}I_{xx} - \dot{r}I_{xz} + qr(I_z - I_y) - pqI_{xz}$$

$$M_y = \dot{q}I_{yy} + pr(I_{xx} - I_{zz}) + (p^2 - r^2)I_{xz}$$

$$M_z = \dot{r}I_z - \dot{p}I_{xz} + pq(I_{yy} - I_{xx}) + qrI_{xz}$$

Where

$\mathbf{F}=(F_x, F_y, F_z)$  is the external force vector  
 $\mathbf{v}=(U, v, w)^T$  is the velocity vector  
 $\mathbf{M}=(M_x, M_y, M_z)$  is the moment vector  
 $\mathbf{H}$  is the angular momentum vector  
 $\omega=(p, q, r)$  is the angular velocity vector  
 $\mathbf{I}$  is the inertia matrix

The external forces and moment are those generated by the aerodynamic forces, including control surfaces, the propulsion, including control thrusters, and by gravity. The six equations of motion given above are non-linear and coupled. This is further complicated by the fact that the aerodynamic forces are highly non-linear, especially at high angles of attack, and coupled.

The control problem of employing the control actuators in a suitable way to achieve good performance and stability thus becomes a non-linear multivariable control problem. The classical approach to this problem is to linearise around an operating point and then study the control of one variable at a time. There are at least two very severe restrictions to this approach: a missile rarely flies at a trimmed equilibrium, and the states of a missile are normally coupled to each other.

Flight mechanics and controls are treated in many textbooks, e.g. Blakelock. A simplified example of missile control in a 2D, pitch direction case is given in Figure 9.



Nomenclature:

$m$	Missile mass
$u$	Missile velocity
$q$	Dynamic pressure
$d$	Body diameter
$S$	Cross section area
$I$	Moment of inertia
$\ell_0$	Distance between centre of pressure and centre of gravity
$\ell_t$	Distance between tail rudder and centre of gravity
$C_{N\alpha}$	Aerodynamic derivative, normal force per unit of angle of attack
$C_{N\delta}$	Aerodynamic derivative, normal force per unit of elevator deflection
$C_{mq}$	Aerodynamic derivative, moment per unit of body rotation rate
$C_{m\alpha}$	Aerodynamic derivative, moment per unit of angle of attack

With variables defined in figure 9 the linearised equations of motion become:

$$\begin{aligned}\ddot{\theta} &= \frac{qS}{I} \left( -\ell_0 C_{N\alpha} \alpha - \ell_t C_{N\delta} \delta + \frac{d^2}{2u} C_{mq} \dot{\theta} \right) \\ \dot{\gamma} &= \frac{qS}{mu} (C_{N\alpha} + C_{N\delta} \delta) \\ \dot{\alpha} &= \dot{\theta} - \dot{\gamma}\end{aligned}$$

The transfer function between velocity vector rotation rate and elevator angle becomes

$$\frac{\dot{\gamma}}{\delta} = k_0 \frac{(1 + \tau_1 s)(1 + \tau_2 s)}{1 + 2\zeta_0 s / \omega_0 + s^2 / \omega^2}$$

With the following values of gain  $k_0$ , eigenfrequency  $\omega_0$  and damping  $\zeta_0$ .

$$\begin{aligned}k_0 &\approx -\frac{qSC_{N\delta}}{mu} \frac{\ell_t - \ell_0}{\ell_0} \\ \omega_0 &\approx \sqrt{\frac{\ell_0 qSC_{N\alpha}}{I}} \\ \zeta_0 &\approx \frac{1}{2u} \left( \frac{I}{m} - \frac{d^2 C_{mq}}{2C_{N\alpha}} \right) \sqrt{\frac{qSC_{N\alpha}}{I\ell_0}}\end{aligned}$$

where it has been assumed that

$$\frac{qSd^2 C_{mq}}{2mu^2 \ell_0} \ll 1$$

These equations show that the fundamental dynamic properties of the missile can vary greatly with velocity, altitude, mass, inertia etc.

The control system should be designed to give the missile sufficient stability and responsiveness for all relevant flight conditions. To design a single controller for all flight conditions is normally not possible. As a consequence many missile controllers use gain scheduling, where a set of operating points are chosen from the set of possible flight conditions. For each of these points the non-linear missile dynamics is linearised and a controller is designed. A scheme for choosing between the controllers, i.e. the gain scheduling, based on some varying parameters such as dynamic pressure and angle of attack is then formulated.

Recent advances in controller design have, however, made it possible to design the controller for all flight conditions at the same time. The currently most promising technique for this is Linear parameter varying (LPV) design, where the plant is assumed to have the form

$$\begin{aligned}\dot{x}(t) &= A(\theta(t))x(t) + B(\theta(t))u(t) \\ y(t) &= C(\theta(t))x(t) + D(\theta(t))u(t)\end{aligned}$$

where  $x$  is the state variable vector,  $y$  is the output,  $u$  is the control input and  $\theta$  is a vector of measured variables. An overview of current issues in missile controller design is found in Ridgely and McFarland.

## Bank-to-turn

Most missiles are roll stabilised in an X or + configuration and use the control actuators to achieve the desired direction of the lateral acceleration. There are, however, missiles where the roll channel has to be given close consideration.

Bank-to-turn guidance requires the missile to manoeuvre with the lateral acceleration in a single body fixed direction. In order to manoeuvre, the missile first has to bank to align the body with the desired direction. Bank-to-turn guidance can be used to decrease the number of control surfaces, and consequently the drag, and can also be required by the propulsion system. Air breathing propulsion such as ramjets can normally only operate under limited variations of angle of attack and can also be sensitive to side slip.

## Trends

Advances in algorithms and computational power will provide missiles with greater manoeuvrability, particularly at high angles of attack, and improved capabilities to optimise the trajectory.

However, the most important trends in the field of guidance and control can be all be described under the label of “integration”:

- Integrated inertial and satellite navigation will provide all sorts of guided weapons with high precision at low cost. Important aspects are the development of small solid state inertial components for use in the automotive industry, and the continuous improvement of the GPS system.
- Integration between guidance and control offers a potential to improve performance. The established division between slower, outer loop guidance and faster, inner loop control can be dissolved using more advanced algorithms.
- Integration between the missile and overall C<sup>4</sup>ISR system will become tighter. High precision targeting can be provided almost in real time. This will enable low cost weapons using precision navigation to attack many targets without using an expensive seeker.

## References

Assarsson A (ed.), *Robotkurs*, Defence Research Establishment, Stockholm, Sweden, 1996. (In Swedish)

Blakelock J H, *Automatic Control of Aircraft and Missiles*, New York: John Wiley and Sons, 1991.

Garnell, P., *Guided Weapon control systems*, Pergamon Press, 1980

Lee, R.G, *Guided Weapons*, London: Brassey's Defence Publishers, 1988.

Ridgely D B and McFarland M B, “Tailoring Theory to Practice in Tactical Missile Control”, *IEEE Control Systems*, December 1999.

Zarchan P, *Tactical and Strategic Missile Guidance*, Washington, DC: American Institute of Aeronautics and Astronautics, 1994.

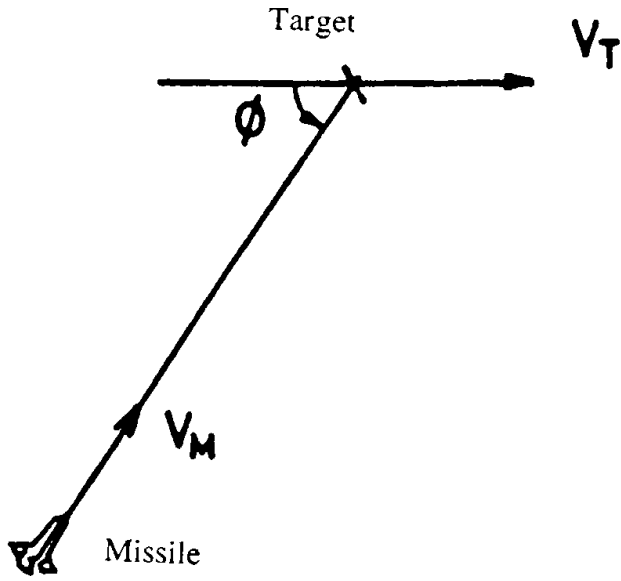

Figure 1. Velocity pursuit kinematics.

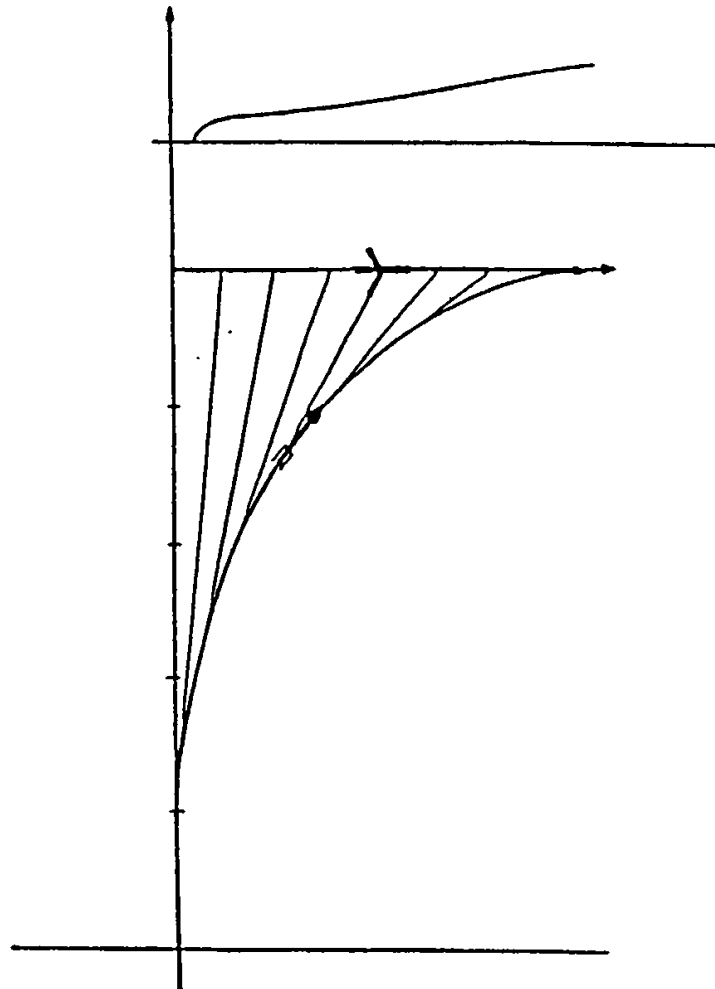

Figure 2. Trajectory and required lateral acceleration for a velocity pursuit missile.  $v_M = 2v_T$ .

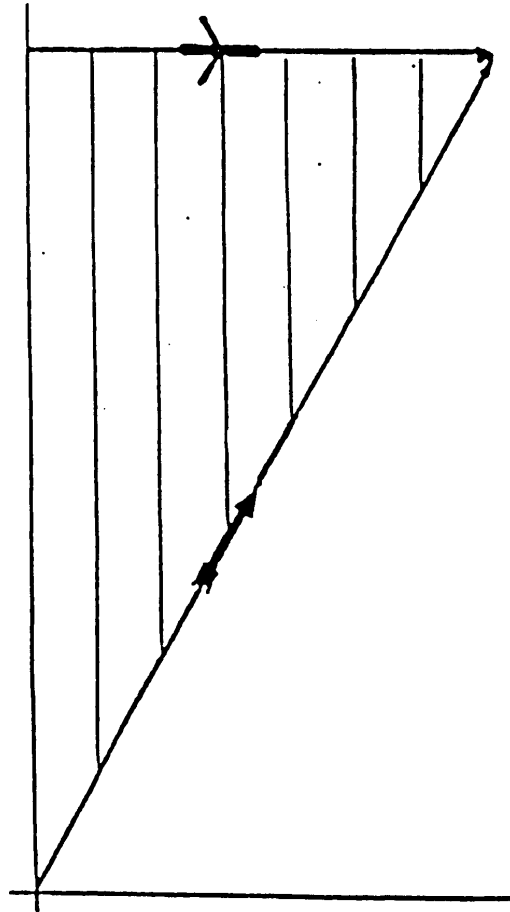

Figure 3. In the ideal collision triangle both the target and the missile move with constant velocity and the bearing to the target is constant throughout the trajectory.

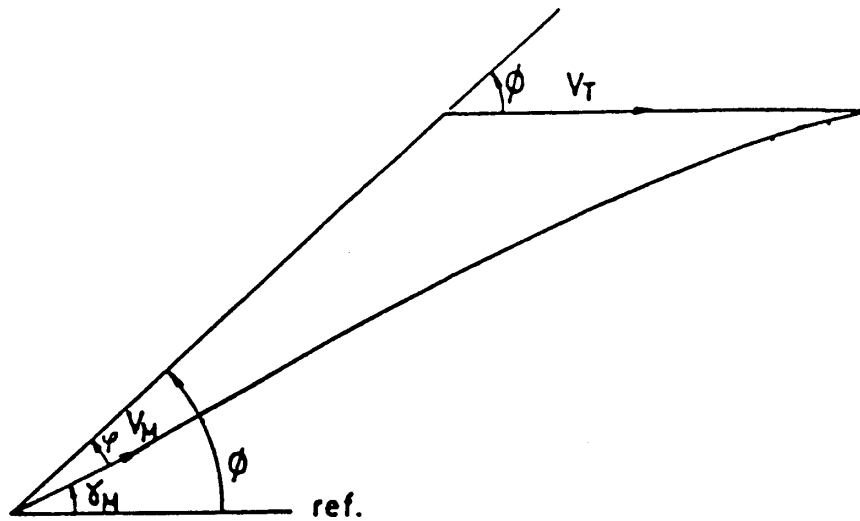

Figure 4. Proportional navigation, kinematics and definition of angles.

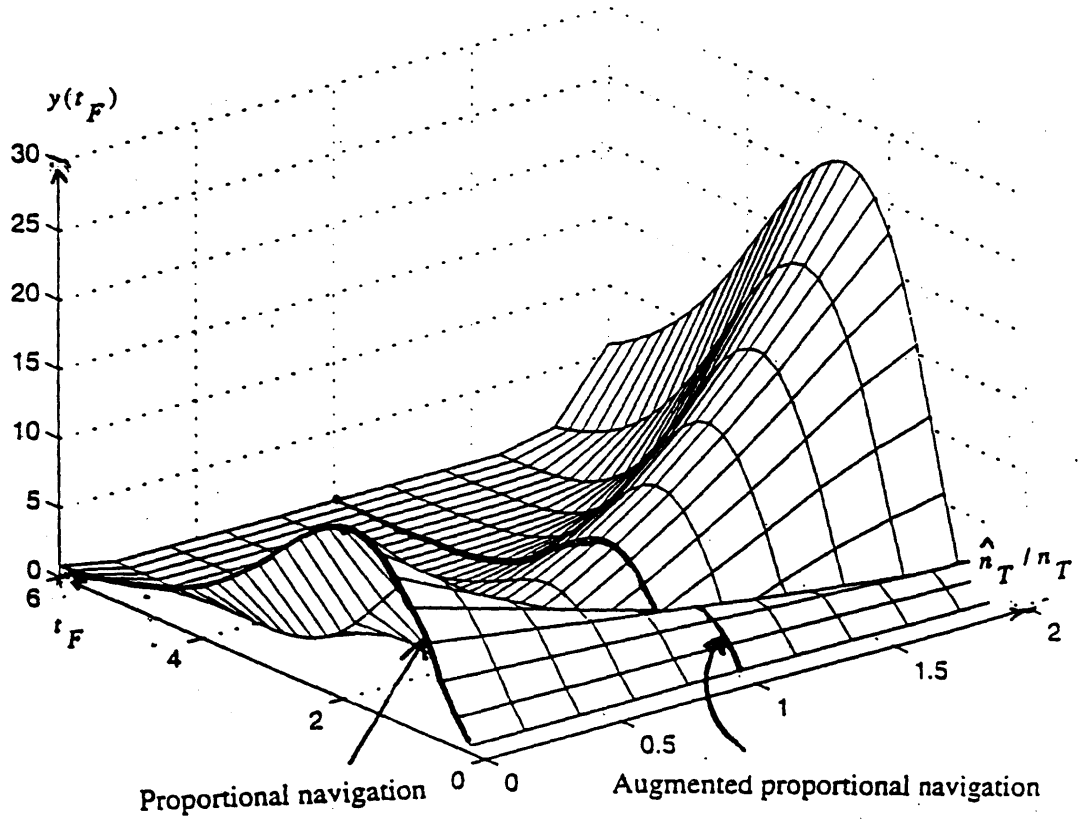

Figure 5. Miss distance in meters as function of time to go at the initiation of the target manoeuvre ( $t_F$ ) and ratio between the estimated target acceleration and the actual acceleration.

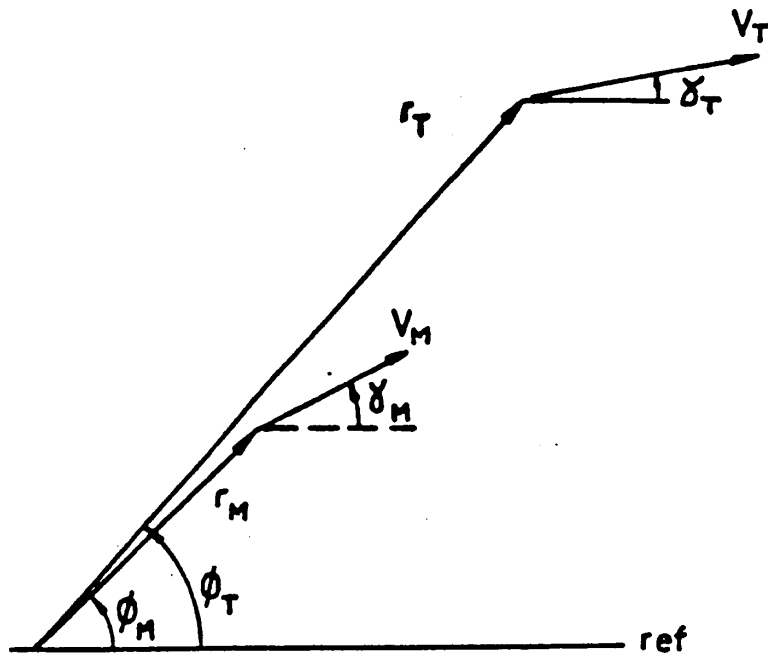

Figure 6. The kinematics of line-of-sight guidance.

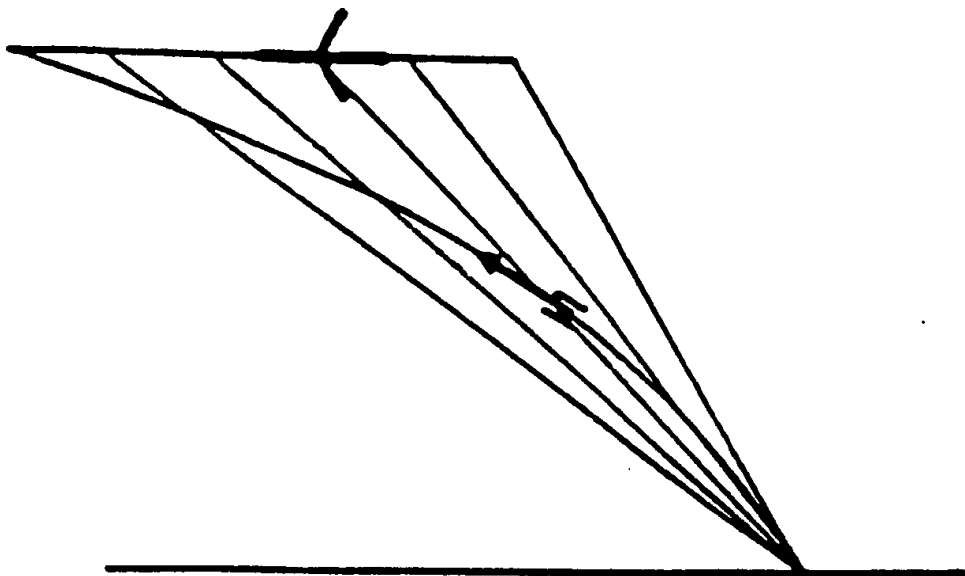

Figure 7. Trajectory of a line-of-sight guided missile.

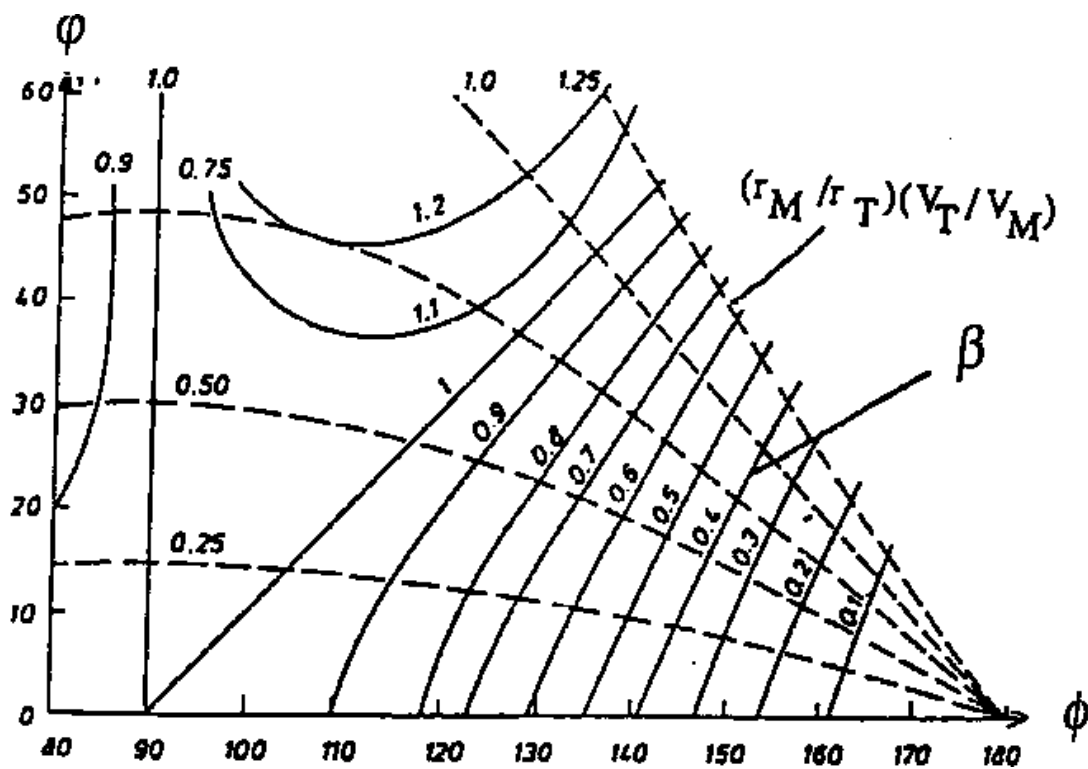

Figure 8. Diagram giving  $\beta$ .

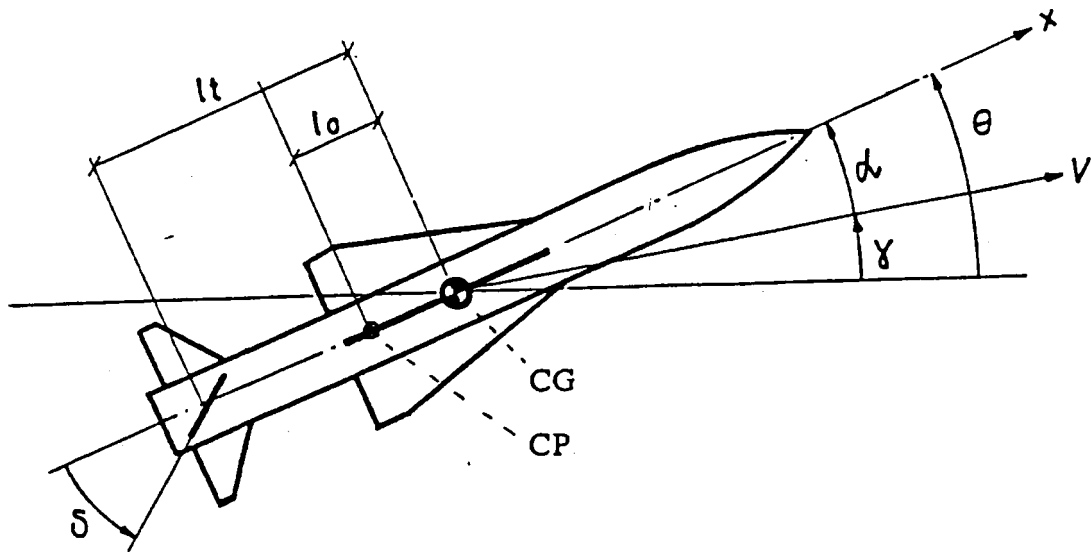

Figure 9. Definitions of variables for the pitch control problem.

**This page has been deliberately left blank**



**Page intentionnellement blanche**



# INS/GPS for Strike Warfare Beyond the Year 2000

**William H. Licata**

Senior Principal Systems Engineer  
3590 New Heritage Drive  
Alpharetta, Ga 30022 US  
[770-475-2318/protono@ieee.org](mailto:770-475-2318/protono@ieee.org)

## Abstract

This paper presents a review of Inertial Navigation Systems (INS) and the Global Positioning System (GPS) as a key technology for Strike Warfare beyond the Year 2000. The paper reviews the functionality that INS/GPS provides the Missile Guidance, Navigation and Control (GNC) designer plus the requirements associated with this functionality. Existing systems on the market are reviewed and new systems that can be expected to enter the market in the 2000 to 2010 time frame are discussed. System issues associated with the use of this hardware and trends in system integration methods are reviewed. The paper concludes with a discussion of the likely future uses of INS/GPS in precision strike missiles.

## Applications of INS/GPS in Strike Warfare

Two primary uses of INS/GPS in Strike Warfare are low cost guidance tailkits for dumb bombs and midcourse guidance for long range precision strike missiles. Tailkits such as JDAM that include an integrated INS/GPS can be attached to dumb bombs and reduce the dispersion of the bombs to the inherent accuracy of the GPS system (15 Meter CEP). These inexpensive guidance kits which do not require a seeker provide a precision strike capability at a much lower cost than weapons requiring a terminal seeker. These INS/GPS guided weapon are only useful for a portion of the fixed targets of interest to Strike Warfare but they provide a very valuable operational capability.

INS/GPS also provides accurate midcourse guidance for long range standoff weapons attacking fixed targets. The INS/GPS midcourse guidance system can guide the weapon accurately enough that when the seeker turns on, the target will be within the field of view of the seeker. There is no need to scan the seeker back and forth to locate the target. The seeker turns on and expects to find the target within the current seeker field-of-view (FOV). After the seeker turns on, acquires and tracks the target, the INS/GPS tracks the target location between target updates. In the presence of cloud cover, INS/GPS guides the weapon through the clouds until the seeker has a clear view of the target. In this scenario, the INS/GPS is viewed as providing a through the clouds attack capability.

## Engageable Threats

The target types that lend themselves to being attacked by INS/GPS guided weapons are primarily stationary targets. Fixed targets can be located and surveyed using reconnaissance assets. The coordinates of these fixed targets can be loaded into the weapon computer and the onboard INS/GPS can guide to the target coordinates.

Special types of fixed targets that cannot be easily surveyed prior to the mission can also be attacked with INS/GPS. An antiradiation missile can use INS/GPS to guide to the last computed target coordinate should the antiradiation seeker lose the target. This can provide an important operational capability to deal with the loss of a threat signal during the missile terminal guidance phase.

Moving or relocatable targets cannot be attacked with a weapon guided solely by INS/GPS. These targets require a seeker to correct for target location uncertainty. However, INS/GPS can help reduce the complexity of the relocatable target acquisition problem for the seeker of choice.

## Response Time

Missile response time from power up to ready for launch can be impacted by the presence of an INS/GPS system. The inertial navigation system must go through an alignment process to find local level and north that can take several minutes. GPS must acquire the satellite signal and decode the signals that can take minutes to accomplish. An integrated INS/GPS can, therefore, become a limiting factor in missile response time.

Two distinct types of alignment scenarios exist for tactical missiles depending on the missile system approach taken to handling this requirement. The INS/GPS system can be aligned on the runway prior to the aircraft taking off. Alignment in this case is easier because the aircraft is stationary, but once aligned, power must remain on the weapon through the aircraft flight. The second approach is in-air alignment that requires aligning the weapon INS/GPS system to the aircraft INS/GPS system. This second approach assumes a modern digital interface to the weapon store location and many older aircraft lack this digital bus. Newer aircraft include a digital bus to the weapon and in-air alignment will grow in popularity in the future.

When performing in-air alignment, the accuracy of the alignment is enhanced by aircraft maneuvers during the alignment process but this approach is unpopular with pilots and could be totally unacceptable in the case of stealth aircraft. Ultimately the in-air alignment accuracy is limited by flexure of the aircraft structure between the aircraft INS/GPS and the weapon INS/GPS. Since GPS acts as a separate external alignment device for the INS, this structural flexure problem is more of a concern when using free inertial systems that do not include GPS.

## Type of Inertial Products

Inertial products come in various configurations. At the lowest level are the inertial instruments that measure the actual missile motion. Angular motion is measured using a gyroscope whose digital output is a linear function of the rotation rate about its input axis. Each gyroscope measures one axis of rotation so three gyroscopes are required to measure the 3 dimensional rotation rate vector of the missile (pitch, yaw and roll). Translational motion is measured using accelerometers whose output is a linear function of the translational acceleration along its input axis. Three accelerometers are required to measure the 3 dimensional acceleration vector of the missile. Older missiles used gyroscopes and/or accelerometers in the missile autopilot to maintain stable missile flight characteristics. Gyroscopes were also used to stabilize the seeker optics or antenna. Figure 1 illustrates the difference between an IMU (Figure 1a) that is a cluster of 3 gyroscopes and 3 accelerometers required to measure the complete missile rotation and acceleration vectors and an INS (Figure 1b) that computes location on the earth using IMU outputs. A missile can use an IMU for autopilot functions and seeker stabilization without adding the computer necessary to compute location on the earth. The trend is towards integrated INS/GPS systems. GPS requires a complete navigation system to maintain synchronization with the satellite signals and the INS needs GPS to keep the navigation error from growing without bound as illustrated in Figure 1b.

## Types of INS Systems

Figure 2 shows pictures of a typical aircraft integrated INS/GPS system and a typical tactical missile INS. There is obviously a significant size difference. The aircraft INS has a larger IMU and this translates into more accurate inertial sensors. The aircraft INS must provide significantly more functionality since an aircraft has many missions and mission packages with a complex set of INS requirements. The aircraft INS holds more electronic circuit cards and often uses temperature stabilization for the inertial measurement cluster. In contrast with the aircraft INS, the missile INS is more limited in its functionality and scope. It uses smaller sensor and smaller electronics. The loss of navigation accuracy with time in the absence of GPS is an order of magnitude higher in the tactical missile INS than the aircraft INS. Since the INS includes an IMU a tactical missile INS can provide the signals required by the missile autopilot, the seeker optics/antenna stabilization, midcourse navigation and terminal guidance requirements.

One trend in tactical missiles that will help reduce the size and cost of tactical INS is to avoid redundant hardware and software through a system architecture that emphasizes a high degree of system integration.

Modern missiles will use one central power supply or one central processor eliminating the need for the INS to have a separate power supply or processor.

### **Example of Current Inertial Products**

Figure 3 shows several pictures of inertial products found at various websites on the internet. Many systems use laser gyroscopes that were developed over a 20 year time frame. The laser gyroscope on the left of figure 3 is the world largest and helps give a better view of the gyroscopes structure. A laser gyroscope uses two counter rotating laser beams that interfere with each other when they meet at one corner of the cube. The degree in interference is a function of the rotation rate about an axis normal to the laser gyroscope. A smaller tactical missile grade laser gyroscope is also shown in figure 3. Figure 3 also shows a more traditional spun rotor gyroscope using a rotating mass driven by a motor. Accelerometers are still primarily the force balance or mass on a spring design. A triad of accelerometers is shown on the bottom right of figure 3. Figure 3 includes one example of an inertial cluster including three orthogonal gyroscopes and three orthogonal accelerometers.

### **Trends in Inertial Sensors**

There are new types of inertial sensors being developed that are expected to enter the market place in the next 5 - 10 years. This includes a fiber optic gyroscope similar to a laser gyroscope but capable of achieving a longer path length by using a spool of fiber optic cable. A fiber optic gyroscope can achieve the same sensitivity as a laser gyroscope but in a much smaller package. A newer technology that has significant commercial market potential is the Micro-Electro-Mechanical Systems (MEMS). MEMS is the integration of mechanical elements, sensors, actuators, and electronics on a common silicon substrate through the utilization of microfabrication technology. These MEMS sensors can be packaged in very small sizes and have the potential for high rate/low cost production. A key factor in the ability of tactical INS manufacturers to build lower cost products will depend on the success of MEMS technology and the development of a commercial market for inertial sensors.

Initially the newer inertial sensors will lack the accuracy of the older sensor designs, but since GPS can work with lower accuracy inertial systems, this will not limit the introduction of these new sensors. As the manufacturing processes for these newer sensors mature, they will reach and perhaps surpass the performance of the current inertial sensors.

### **Missile Guidance Functionality Impacted by INS Performance**

An INS can support many different parts of an integrated missile guidance, navigation and control (GNC) design. This includes:

- source of autopilot measurements of missile short term motion
  - missile rotational rate about the weapon center of gravity and acceleration through the weapon center of pressure
- source of midcourse guidance information on missile location relative to the expected target location
- source of seeker measurements of missile motion required to support
  - sensor compensation
    - imaging sensor
  - image motion stabilization
    - radar
      - range and/or velocity to scene center
    - synthetic aperture radar - image formation
      - short term missile motion
  - sensor cueing
    - point where the target is expected to be - sets search area

- ATR cueing
  - fixed target approach angles plus range to target
- multisensor fusion
  - change in missile aspect between different sensor collection times
- source of guidance commands between sensor updates
  - guides after sensor goes blind

All these GNC functions have different requirements that must be integrated into the total design requirement for the integrated INS/GPS. Balancing these different design requirements without growth in the cost of the INS/GPS system is a very challenging design problem.

### **Missile INS Need Statement**

A missile needs an INS/GPS primarily to guide the missile to the target area when the launch range is beyond lock-on before launch ranges or the missile does not contain a seeker. The missile also needs an INS/GPS system to keep the missile seeker pointed at the target during missile maneuvers. As already mentioned to guide a weapon over long ranges with a tactical grade INS would require a very expensive INS with low drift rate or GPS as a navigation update device. Many new sensors also have short acquisition range so there isn't much time for the seeker to scan around and search for the target. An accurate INS/GPS system can often guide the missile to the target to sufficient accuracy that the target will be in the sensor field-of-view at sensor turn-on.

A secondary missile need for an INS in the case of fixed targets is providing the automatic target recognition (ATR) system information on the target viewing angles and range to the target at sensor turn-on. This information significantly reduces the complexity of the ATR problem for fixed targets. This need for an INS/GPS to reduce ATR complexity is not as well understood by missile designers today nor is it understood how to exploit INS/GPS to reduce the complexity of the moving or relocatable target ATR problem.

### **Missile Performance Metrics Impacted by INS/GPS Performance Metrics**

The performance of the integrated INS/GPS system impacts several important missile level performance metrics. The most obvious metric that is impacted is the missile circular error probability (CEP). This is especially the case for missiles that are totally guided using an INS/GPS. In the case of INS/GPS guidance the CEP is limited by a combination of GPS accuracy and target location accuracy. Normally the CEP of an INS/GPS guided weapon is on the order of 15 meters.

INS/GPS performance also impacts the maximum weapon range. This is especially the case when GPS is not used and midcourse guidance is free inertial. In the case of INS/GPS the impact is only seen if the missile operational scenario includes a GPS jammer in the target area. GPS has made it easier to fly longer midcourse navigation ranges prior to seeker turn-on.

INS/GPS can provide a degree of adverse weather performance. INS/GPS weapons can attack fixed targets through the clouds. Laser guided weapons or optical guided weapon cannot penetrate cloud cover and must acquire the target after penetrating the cloud cover. INS/GPS also helps to hold the missile on the target when the seeker line of sight to the target is interrupted for any reason or the seeker temporarily locks onto a false target.

INS/GPS performance impacts the type of target that can be attacked. Fixed targets are very compatible with INS/GPS guidance. Relocatable or moving targets require a seeker but INS/GPS can reduce the seeker search area. Therefore, the INS/GPS performance will impact the performance of the missile across the total mission target set.

INS/GPS performance impacts warhead effectiveness. The INS/GPS makes it easier to achieve the terminal impact condition required for maximum warhead effectiveness. This includes the impact angle and angle of attack of the missile at target impact.

## INS Error Model

Figure 4 shows a simple error model for the INS system. Since the inertial measurement devices measure rotational rate and translational acceleration, the computer in the INS must integrate these measurements to obtain missile attitude, translation velocity and position. The block diagram shown in figure 4 is made up of several integrators. The errors associated with the different inertial sensors pass through a different number of integrators. The more integrators the errors pass through, the faster the associated position error grows with time. For example, gyro bias is integrated to create a tilt error that multiplies gravity to create an acceleration bias. The acceleration bias associated with the gyro bias induced tilt error is double integrated to create a position error that grows with the third power of time. The velocity bias error only passes through one integrate and grows with the first power of time.

It is possible to misinterpret these different errors and their impact on position error as a function of time. For short time of flights, the velocity bias dominates even though it grows only linearly with time. Gyro drift dominates for long times of flight since it grows with the cube of time. One reason is that velocity bias is usually larger than the acceleration bias and it is usually larger than the gyro bias.

All the INS errors can in general be approximated as an error of the form  $kt^n$  where  $k$  is a constant including the error term,  $t$  is time and  $n$  is the power 0, 1, 2 or 3. These simple error models are very compatible with computing INS errors using a handheld calculator or a spreadsheet. Computing the errors when GPS is used to update the INS is even simpler since the position and velocity errors are fixed by GPS in the steady state and that is normally the phase of interest to the missile designer.

Figure 5 shows the position error growth as a function of time caused by acceleration bias and gyro drift starting from a perfect alignment. Note that for the short term, there is little difference between these INS units. In the long term, the curves diverge considerably because of the difference in gyro drift rates. This long term drift is only important for missile designs that do not include GPS or in the case of GPS jamming.

## Missile Motion and INS Performance

So far, all the discussions about the INS/GPS system has dealt with very low frequency motion which can be represented by powers of time. Navigation systems traditionally are concerned with low frequency motion measurement as illustrated in figure 6. Imaging sensors such as synthetic aperture require the measurement of motion frequencies higher than frequencies traditionally of interest to navigation designers. These sensors need an accurate measurement of short term motion and even require measurement of missile vibration that might be induced by the propulsion system or actuator motion. As figure 6 illustrated, vibration can extend far beyond traditional motion frequencies. Accurately measuring this high frequency motion is a new requirement for INS designers and not yet fully understood by many.

As figure 7 illustrates, measuring the higher frequency motion of a missile requires a higher sampling rate and falls more into the area of expertise of the digital signal processing designer than the navigation designer. This high frequency motion measurement must concern itself with small changes in position on the order of a radar wavelength. A need exists to balance the INS design between the needs of the midcourse navigation system and the imaging seeker needs.

## New Tactical Grade INS Systems

Figure 8 shows a sample of new or proposed tactical grade INS units based on emerging technologies. Perhaps only one of these new units will reach high rate production. These units will probably not fill all the needs of future tactical missiles. The missile GNC designer will have to develop design architectures that fit

these new INS units at costs consistent with new procurement guidelines. There will be many challenging design problems but these products will help reduce the cost of future tactical missiles.

### Integrated INS/GPS Cost

Since cost is very important in the current military acquisition approach for tactical missiles, it is necessary to point out that cost includes not only the selling price but also the warranty cost and repair cost. It is not unusual today for the military to require a warranty on new missile and require the supplier to maintain and repair the weapon. Inertial products developed for the commercial market place may not be compatible with a 10, 15 or 20 year warranty. Validating a warranty may take a sizeable investment and require some redesign of units currently under development.

Tied to cost is risk management. There are many risks associated with phasing a new INS into a production missile. The trend is to go with an INS that is already in production so new INS system will first be introduced for those applications that have strong needs such as small package sizes below those currently produced.

### Summary and Conclusion

In summary, integrated INS/GPS systems are a key technology for tactical missiles and will provide increasing levels of functionality as missiles include advanced imaging seekers and seekers incorporate automatic target recognition. This trend towards increased use of integrated INS/GPS systems is supported by the development of small tactical grade INS units using MEMS and fiber optic technology. INS designers have to increase their understanding of new INS requirement created by imaging infrared and radar sensors.

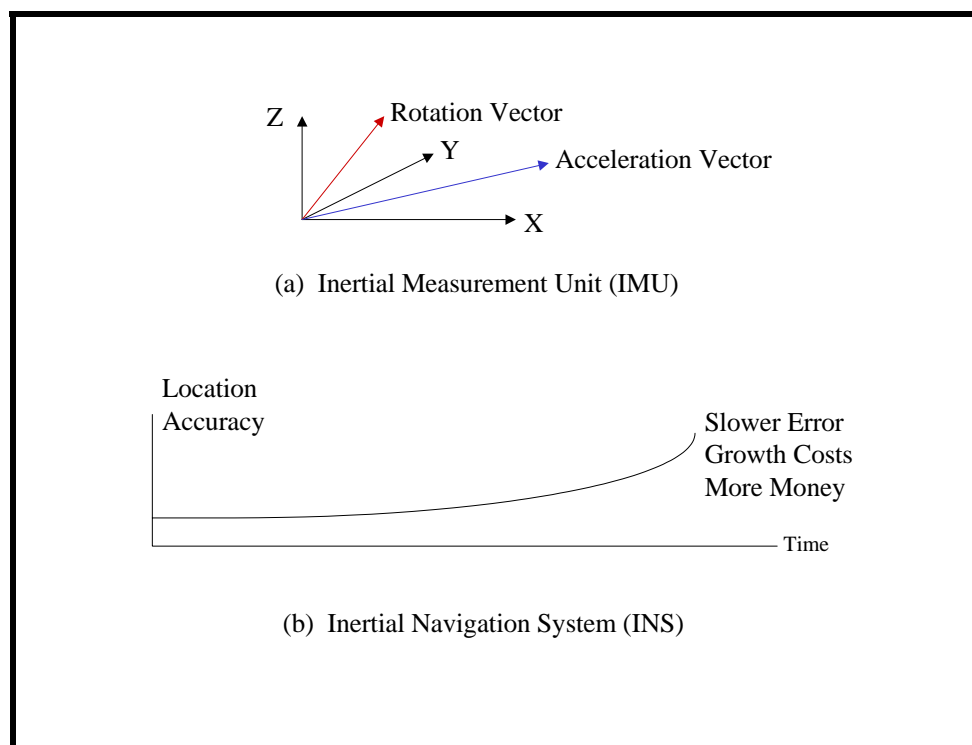

Figure 1. IMU versus INS



(a) Aircraft Grade INS



(b) Tactical Grade INS

**Figure 2. Size Variation in INS Systems**

Worlds Largest Laser Gyro

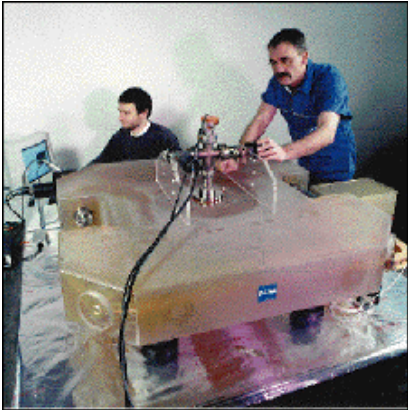

Measure Rotation of Earth



Laser Gyro



Strategic Missile Accelerometer



Inertial Cluster



Accelerometer Triad

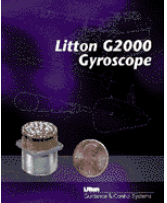

Litton G2000 Gyroscope

**Figure 3. Sampling of Inertial Products**

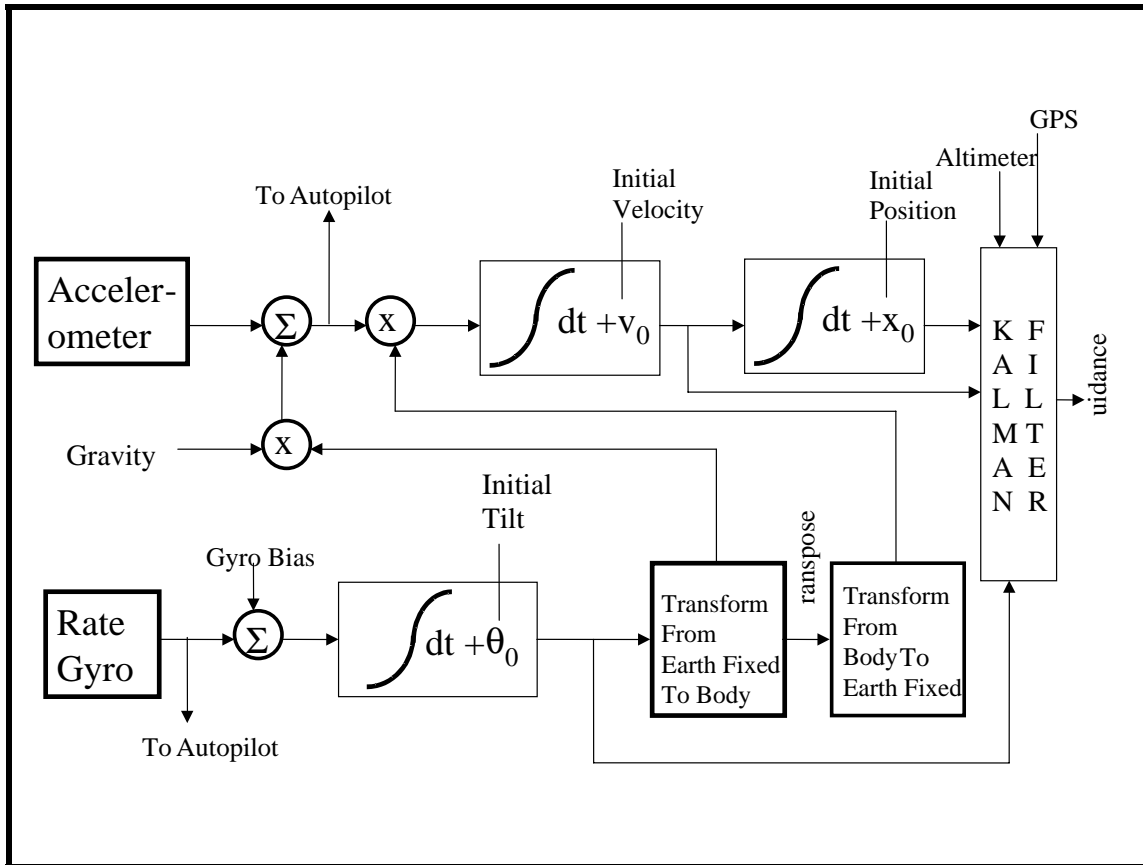

Figure 4. INS Error Model

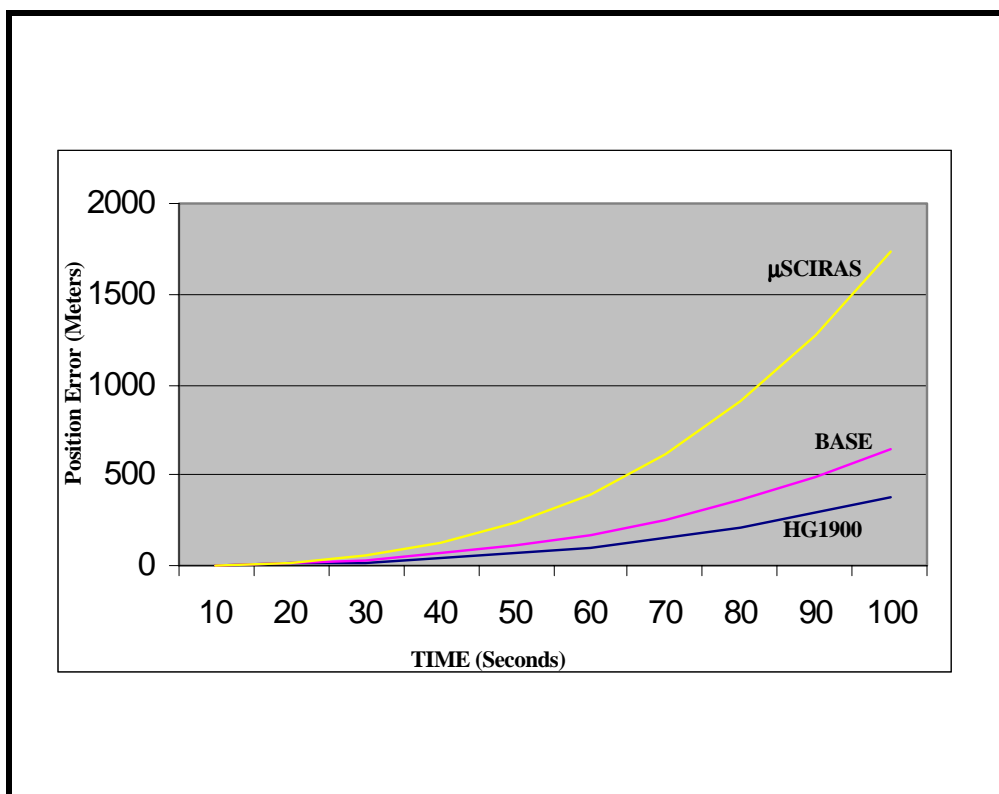

Figure 5. Representative Tactical Grade INS Position Growths



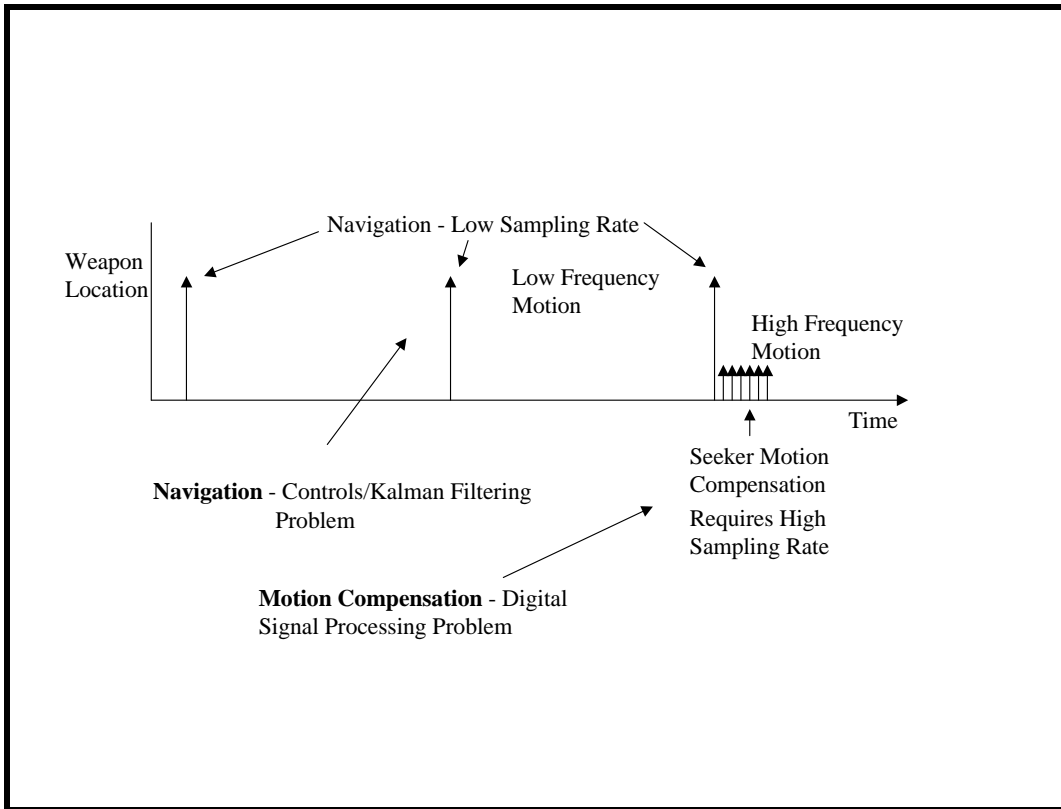

Figure 6. Motion Signal Processing Design

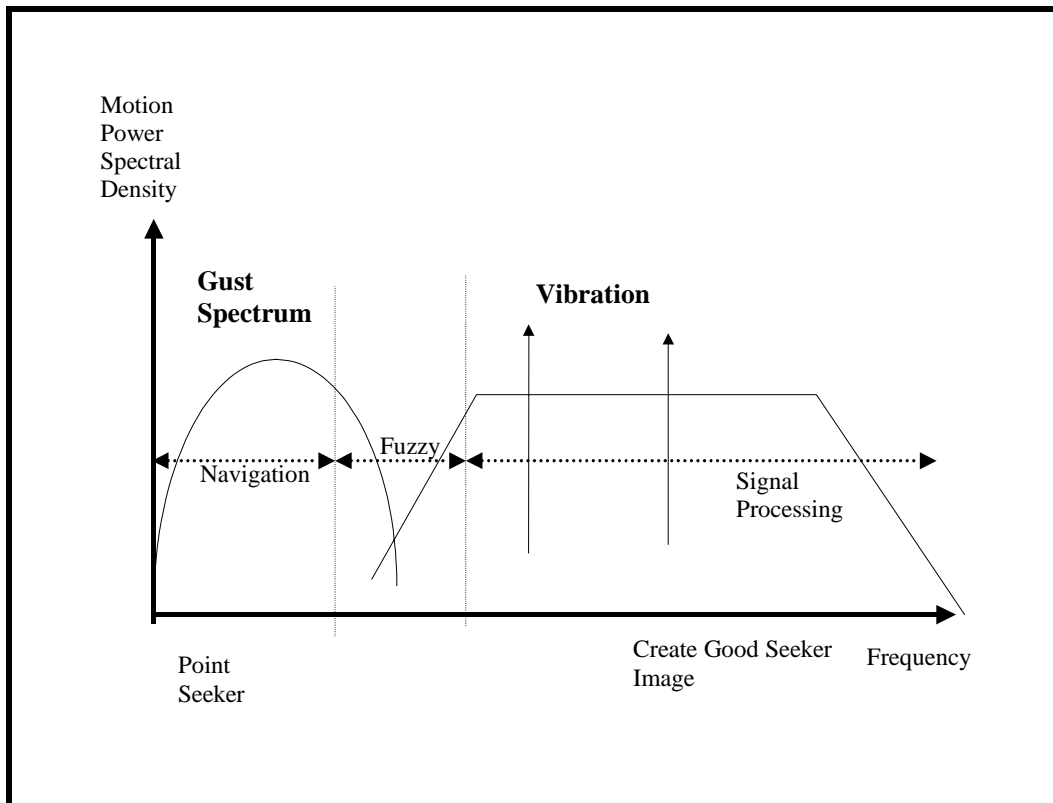

Figure 7. Missile Motion Bandwidth and INS Function



**Figure 8. Sampling of New or Proposed Tactical Grade INS Systems**

# **Technologies for Future Precision Strike Missile Systems - Missile Design Technology**

**Eugene L. Fleeman**

Aerospace Systems Design Laboratory  
School of Aerospace Engineering  
Georgia Institute of Technology  
Atlanta, Georgia 30332-0150, United States  
[Eugene.Fleeman@asdl.gatech.edu](mailto:Eugene.Fleeman@asdl.gatech.edu)

## **Abstract/Executive Summary**

This paper provides an assessment of the state-of-the-art and considerations of missile design technology for future precision strike missile systems. Benefits of missile design technology include new advanced missile concepts, identification of driving parameters, balanced subsystems, incorporation of new technologies, light weight/low cost missiles, and launch platform compatibility. The paper discusses the missile design process, presents examples of simulation and spreadsheet conceptual design computer programs, provides missile configuration design criteria, and lists references that are applicable to missile design technology.

## **Missile Design Process**

Figure 1 shows the relationship of missile design to the development process of research, technology, and acquisition. Conceptual design is most often conducted during the exploratory development phase of missile development. A primary objective of exploratory development is to investigate and evaluate technology alternatives. The advanced technology development phase of missile development is intended to mature the enabling technologies of key subsystems. Although conceptual design may also be conducted during advanced development, preliminary design methods are usually more appropriate. Preliminary design continues during advanced development demonstration of the prototype missile. Following successful demonstration of a prototype, the program moves into engineering and manufacturing development (EMD). At this point more detail design methods are appropriate for the operational missile. However, the assessment of possible future block upgrades may require the reintroduction of preliminary design and conceptual design activities.

Conceptual design and sensitivity studies should be conducted early in the exploratory development process, and continued into advanced development. Many of the cost and performance drivers may be locked in during the conceptual design phase. It is important to quickly evaluate a large number of alternatives that cover the feasible design solution space.

An indicator of design maturity is the number of drawings that are required to describe the design. Conceptual design may be characterized by approximately five drawings for each concept, describing perhaps five subsystems. A large number of alternative concepts, perhaps ten, are in evaluation during conceptual design. Conceptual design drawings include the missile overall dimensions, major subsystems layout, and may also list the major subsystems mass properties. The next step is preliminary design. Preliminary design drawings of a prototype missile are usually characterized by up to 100 drawings, with greater detail and showing up to 100 components. Preliminary design drawings have fully dimensioned subsystems, inboard layouts showing the subsystems, individual subsystem and component drawings, and dimension tolerances. A fewer number of alternative missile concepts, perhaps four, are under evaluation during preliminary design. Following preliminary design, the next step is detail design. Detail design for EMD usually requires more than 100 drawings and often has more than 1,000 drawings. EMD drawings have even greater detail, including drawings of each part, detailed work assembly instructions and descriptions of the manufacturing processes. During EMD there is usually only one concept by a sole source contractor.

Figure 2 shows a typical missile conceptual design process. Conceptual design is an iterative process, requiring a balance of emphasis from the diverse inputs and outputs. The major tasks of conceptual design are 1) mission/scenario definition; 2) weapon requirements, trade studies and sensitivity analysis; 3) physical integration of the missile with the launch platform; 4) weapon concept design synthesis; and 5) technology assessment and technology development roadmap documentation. The initial design process begins with a general definition of the mission/scenario. Mission/scenario definition can have one or more updates during the design process. The initial input is a “requirements pull” desired capability from the military customer. It is evaluated against the “technology push” potential technology availability provided by the technical community. The weapon requirements, trade studies, and sensitivity analysis task provides the high level requirements on the missile such as range, time to target, and other measures of merit. This task is oriented towards an operations analysis of a system-of-systems, including targeting. The high level requirements may be derived from campaign, raid, or engagement models. In a campaign model many different types of systems are interacting over a simulated time interval from days to weeks. A raid model has multiple platforms engaging multiple targets. An engagement model may be that of a single launch platform and missile engaging a single target or threat. The third task, physical integration of the missile with the launch platform, provides constraints such as length, span, and weight. This task is oriented towards systems integration. The fourth task, weapon concept design synthesis, is the most iterative and arguably the most creative. Characteristics such as the aerodynamic shape, propellant or fuel type and weight, flight trajectory range, time to intercept, maneuverability, seeker detection range, accuracy, lethality, and cost are evaluated; and the missile is resized and reconfigured in an iterative process. As the design matures and becomes better defined through iteration, the number of alternative solutions is reduced from a broad range of possibilities to a smaller set of preferred candidates. More in-depth information is provided for the design subsystems as the design matures. Finally, a technology assessment task further defines the subsystems and selects the best technology from the candidate approaches. The technology trades lead to a set of preferred, enabling technologies. A technology roadmap documents the development plan for maturing the enabling technologies.

A typical duration for a conceptual design activity is three to nine months. The products of the missile design activity include refined mission/scenario definitions, system-of-systems definition of the missile requirements, launch platform compatibility compliance, advanced missile concepts, identification of the enabling technologies, and a technology roadmap. Conceptual design is an opportunity to harmonize diverse inputs early in the development process. The military customer has the lead in providing the “requirements pull” initial input for the mission/scenario definition task. The mission/scenario definition may be modified later as a result of the “technology push” of available capability. The system-of-systems weapon requirements, trade studies, and sensitivity analysis is usually conducted by operations analysis personnel. System integration engineers usually lead the task to integrate the missile with the launch platform. Missile design engineers lead the task to synthesize missile concepts. Finally, technical specialists provide the lead input for the “technology push” of potentially available technical capability and the technology development roadmap.

Examples of design alternatives for lightweight, air-launched multi-purpose precision strike weapons and their system considerations are shown in Figure 3. The selected examples are relatively lightweight air-launched missiles, because of the importance of firepower. Firepower is especially important for lightweight fighter aircraft, helicopters, and UCAVs, which may have a firepower limitation due to a store weight limit. Current operational air-launched precision strike missiles that are relatively lightweight include AGM-65 Maverick, Small Smart Bomb, AGM-88 HARM, Brimstone/Longbow/Hellfire, and LOCAAS. Measures of merit shown are the effectiveness against fixed surface targets, effectiveness against moving targets, effectiveness against time critical targets, effectiveness against buried targets, effectiveness in adverse weather, and the firepower loadout on the launch aircraft. Note that no one operational missile is superior in all areas. Small Smart Bomb has good effectiveness against fixed surface targets, has good effectiveness against buried targets, is capable of operation in adverse weather, and is relatively light weight (100, 250, and 500 pounds), providing high firepower. However Small Smart Bomb is relatively ineffective against moving targets and time critical targets. A new lightweight precision strike missile that combines the attributes of a small smart

bomb with the capability to handle moving targets and time critical targets would be more robust. Examples of technologies that provide robustness to handle a broad range of targets include:

- GPS/INS precision guidance
- SAR or imaging millimeter wave seeker for adverse weather homing
- Ducted rocket propulsion for higher speed and longer range
- Low drag airframe for higher average speed and longer range
- Multi-mode kinetic energy/blast fragmentation warhead
- Light weight subsystems for a lighter weight missile

Figure 4 shows the iterative process used for conceptual design synthesis. Based on mission requirements, an initial baseline from an existing missile with similar propulsion is established. It is used as a starting point to expedite the design convergence. Advantages of a baseline missile include the prior consideration of balanced system engineering for the subsystems and the use of an accurate benchmark based on existing test data (e.g., wind tunnel data). Changes are made in the baseline missile aerodynamics, propulsion, weight, and flight trajectory to reflect the new requirements of the new missile concept. The new conceptual design is evaluated against its flight performance requirements (e.g., range, time to target, maneuver footprint). The aerodynamics portion of the conceptual design process is an investigation of alternatives in configuration geometry. The output of the aerodynamics calculation is then inputted to the propulsion system design to size the propulsion system. Propulsion sizing includes providing sufficient propellant or fuel to meet the range and time-to-target requirements. The next step is to estimate the weight of the new missile with its modified aerodynamics and propulsion. Much of this activity is focussed on structural design, which is sensitive to changes in flight performance. Following the weight sizing, flight trajectories are computed for the new missile. The range, terminal velocity, maneuverability, and other flight performance parameters are then compared with the mission flight performance requirements. If the missile does not meet the flight performance requirements, it is resized and reiterated. After completing a sufficient number of iterations to meet the flight performance requirements, the next step is evaluating the new missile against the other measures of merit and constraint requirements. If the missile does not meet the requirements, the design is changed (alternative configuration, subsystems, technologies) and resized for the next iteration and evaluation.

A synthesized missile will differ from the starting point baseline in several respects. For example, the wing area may have been resized to meet the maneuverability requirement. The tail area may have been resized to meet static margin and maximum trim angle of attack requirements. The rocket motor or the ramjet engine may have been modified to improve its efficiency at the selected design altitude or Mach number. Additionally, the length of the propulsion system may have been changed to accommodate additional propellant/fuel necessary to satisfy flight range requirements. The design changes are reflected in revisions to the mass properties, configuration geometry, thrust profile, and flight trajectory for the missile. Typically, three to six design iterations are required before a synthesized missile converges to meet the flight performance requirements.

Figure 5 is an example of baseline data that is used in conceptual design sizing. The example is based on a chin inlet, integral rocket ramjet. Other examples could be based on the precision strike missiles shown in Figure 4. In the upper left of the figure is an illustration of a configuration drawing of the baseline missile. The configuration drawing is a dimensioned layout, with an inboard profile showing the major subsystems (guidance, warhead, fuel, booster/engine, and flight control surfaces). In the upper center of the figure are examples of tables for a missile weight statement and geometry data. Missile weight and center-of-gravity location are provided for launch, booster burnout, and engine burnout flight conditions. Weight and geometry data are also provided for the major subsystems. The upper right corner of the figure is an illustration of a description of ramjet internal flow path geometry. The internal flow path geometry data includes the inlet design capture area and the internal areas of the inlet throat, diffuser exit, flame holder plane, combustor exit, nozzle throat, and nozzle exit. Examples of aerodynamic data plots are illustrated in the left center section of the figure. Aerodynamic data for the ramjet baseline covers angles of attack up to 16 degrees and Mach numbers up to 4.0. Aerodynamic coefficients and derivatives include zero-lift drag coefficient ( $C_{D0}$ ), normal force coefficient ( $C_N$ ), pitching moment coefficient ( $C_m$ ), pitching moment coefficient control effectiveness derivative ( $C_{m\delta}$ ), and normal force coefficient control effectiveness derivative ( $C_{N\delta}$ ). Examples of ramjet

propulsion thrust ( $T$ ) and the ramjet specific impulse ( $I_{SP}$ ) are shown in the center of the figure. Thrust and specific impulse are functions of Mach number and fuel-to-air ratio. Rocket booster propulsion thrust, boost range and burnout Mach number are illustrated in the right center of the figure as a function of launch Mach number and altitude. The left bottom section of the figure shows the maximum flight range of the ramjet baseline. Maximum flight range is a function of launch Mach number, launch altitude, cruise Mach number, and cruise altitude. Finally, the right bottom section of the figure is an example of the sensitivity of design parameters on maximum flight range. Sensitivity parameters include inert weight, fuel weight, zero-lift drag coefficient, lift-curve-slope derivative ( $C_{L\alpha}$ ), ramjet thrust, and ramjet specific impulse. The sensitivity study in the example was conducted for cruise flight conditions ranging from Mach 2.4, sea level to Mach 3.0, 60K feet altitude.

Figure 6 is a summary of the aerodynamic configuration sizing parameters for precision strike missiles. *Flight condition* parameters that are most important in the design of tactical missiles are angle of attack ( $\alpha$ ), Mach number ( $M$ ), and altitude ( $h$ ). For the aerodynamic configuration, the missile *diameter* and *length* have a first order effect on characteristics such as missile drag, subsystem packaging available volume, launch platform integration, seeker and warhead effectiveness, and body bending. Another configuration driver is *nose fineness*, an important contributor to missile drag for supersonic missiles. Also, nose fineness affects seeker performance, available propellant length, and missile observables. Another example is missile *propellant/fuel* type and weight, which drive flight performance range and velocity. The aerodynamic configuration *wing geometry and size* are often set by maneuverability requirements. *Stabilizer geometry and size* are often established by static margin requirements. In the flight control area, the *geometry and size of the flight control surfaces* determine the maximum achievable angle of attack and the resulting maneuverability. Finally, the *thrust profile* determines the missile velocity time history.

The flight trajectory evaluation activity under missile concept synthesis requires consideration of the degrees of freedom to be simulated. Figure 7 compares the simulation modeling degrees of freedom that are usually used in conceptual design with the degrees of freedom that are appropriate for preliminary design. As discussed previously, conceptual design is the rapid evaluation of a large range of alternatives. It requires that the design methods be fast, easy to use, and have a broad range of applicability. The simplest model, often acceptable for the conceptual design of high-speed missiles, is one degree of freedom. One degree of freedom modeling requires only the zero-lift drag coefficient, thrust, and weight. Analytical equations can be used to model a one-degree-of-freedom simulation. Other models used for conceptual design are two degrees of freedom point mass modeling, three degrees of freedom point mass modeling, three degrees of freedom pitch modeling and four degrees of freedom roll modeling. In the 4DOF roll modeling the normal force, axial force, pitching moment, rolling moment, thrust, and weight are modeled for a rolling airframe missile. Finally, missile simulation during preliminary design is usually modeled in six degrees of freedom (6DOF). The 6DOF simulation includes three forces (normal, axial, side), three moments (pitch, roll, yaw), thrust, and weight. Missile degrees of freedom greater than 6DOF describe the structure bending modes. Because most tactical missiles are relatively stiff, modeling at greater than 6DOF is usually not required for aerodynamic control missiles but may be required for impulse reaction jet control missiles.

It is instructive to examine the equations of motion for missile design drivers. Figure 8 shows the equations of motion for three degrees of freedom with pitch modeling. The figure shows the missile angular acceleration ( $\ddot{\theta}$ ), rate of change in the flight path angle ( $\dot{\gamma}$ ), and the rate of change in the velocity ( $\dot{V}$ ). The configuration sizing implication from examining the angular acceleration equation shows the importance of control effectiveness. High control effectiveness is provided by high pitching moment control effectiveness ( $C_{m\delta}$ ), low static stability ( $C_{m\alpha}$ ), small moment of inertia ( $I_y$ ), and large dynamic pressure ( $q$ ). A small moment of inertia is a characteristic of a lightweight missile. The second equation shows the design drivers for missile maneuverability. High maneuverability is the capability to make large and rapid changes in the flight path angle. This occurs for large normal force coefficient ( $C_N$ ), lightweight ( $W$ ), and large dynamic pressure ( $q$ ). Large  $C_N$  is achievable through large values of  $C_{N\alpha}$ ,  $\alpha$ ,  $C_{N\delta}$ , and  $\delta$ . Implications of the third equation are missile speed and range. High-speed and long-range are provided by large total impulse, or the integral of thrust for the burn time duration ( $\int T dt$ ). There is also payoff for flight range in using higher density propellant/fuel. Higher density propellant/fuel increases the total impulse of a volume limited propulsion

system. The third equation also shows that low axial force coefficient ( $C_A$ ) and low dynamic pressure provide longer range. Axial force coefficient is approximately equal to the zero-lift drag coefficient ( $C_{D_0}$ ).

## Examples of Missile Conceptual Design Simulation Programs

Two fundamental requirements for computer programs used in conceptual design are fast turnaround time and ease of use. Fast turnaround is necessary to search a broad solution space with a sufficient number of iterations for design convergence. A good design code connects the missile physical parameters directly to a trajectory code that calculates flight performance. The conceptual design methods should be simple physics-based methods, incorporating only the most important, driving parameters. Baseline missile data should be imbedded in the code, to facilitate startup. More detailed computational methods are used later in preliminary design, when the number of alternative geometric, subsystem, and flight parameters has been reduced to a smaller set of alternatives. As an example, it is inappropriate to use computational fluid dynamics (CFD) in conceptual design. The mathematical considerations of CFD (e.g., mesh size, time interval, numerical stability, turbulence modeling, smoothing) are impediments to the fast turnaround time that is required for conceptual design. Similarly, a 6DOF trajectory simulation is inappropriate during conceptual design for the convenient evaluation of guided flight. The development of the required autopilot for 6DOF guided flight is time consuming, diverting emphasis from other more appropriate considerations. Similarly, missile optimization codes are generally inappropriate for conceptual design. Optimization in conceptual design is best left to the creativity and the intuition of the designer. Optimization codes work best when there is a continuous smooth variation in parameters, which is usually not the case in conceptual design. For example, optimization codes do not work well in comparing ramjet propulsion versus rocket propulsion. The CFD, 6DOF guided flight trajectory simulations, and optimization codes have seductive "precision." However more often than not their accuracy in conceptual design is worse than simpler methods. Simpler aerodynamic and simulation methods, combined with a well defined baseline missile and the designer's creativity and intuition are a preferable approach for alternatives selection, sizing, and optimization. They are invariably more accurate and robust.

## Advanced Design of Aerodynamic Missiles (ADAM).

The following discussion of the ADAM missile simulation program is provided as an example of a computer program that generally meets the conceptual design criteria of fast turnaround, ease of use, and applicable to a broad range of configurations and flight conditions. ADAM is a DOS code that runs on a PC. ADAM may have compatibility problems with higher speed computers. It may require a compatible timing hardware emulation setting, to reduce the rate at which the computer's timer sends timing. The ADAM aerodynamics predictions are based on slender body theory and linear wing theory. The aerodynamic methods cover subsonic to hypersonic Mach numbers and angles of attack up to 180 degrees. The ADAM aerodynamics module calculates force and moment coefficients, static and dynamic stability derivatives, trim conditions, control effectiveness, and center of pressure location. Modeling of the equations of motion can be in three, four, five, or even six degrees of freedom (unguided flight). The three degrees of freedom flight trajectory model runs faster than real time. A thirty-second time of flight requires about eight seconds of run time. The 6DOF flight trajectory simulation is used to analyze the nutation/precession modes of missiles during their unguided portion of flight, as well as unguided bombs and unguided projectiles. It requires longer run time. For homing missiles, proportional guidance is used as well as other guidance laws. The input to the ADAM flight trajectory module is provided automatically by the aerodynamics module, simplifying the user input. The benchmark missiles used in the aerodynamics module have corrected coefficients and derivatives based on wind tunnel data. Greater than fifty input parameters are available. The input default is the baseline missile parameters, simplifying the input data preparation.

The baseline missiles in ADAM include air-to-air (e.g., Archer), surface-to-air (e.g., Patriot), air-to-surface (e.g., Hellfire), and surface-to-surface (e.g., ATACMS) missiles. The aerodynamic modeling of the body includes the diameter, nose configuration (geometry, fineness, bluntness), body bulge, boattail, and length. The body cross section may be circular or elliptical. Up to three surfaces (stabilizers, wings, and controls) can be specified. The geometric modeling of each surface includes: the location, leading edge root and tip station, span, trailing edge root and tip station, thickness, control surface deflection limit, and the number of surfaces.

The program models the missile center-of-gravity variation from launch to burnout. For propulsion, the thrust is modeled as a two value thrust profile, of a given time duration. The propellant weight of each thrust-time phase can also be specified. The target can be fixed or moving. Down range and cross range of the target are specified, as well as the target altitude and velocity. Launch conditions for the missile are specified, including altitude, velocity, launch angle, and the guidance law. The output of the three degrees of freedom pitch simulation modeling includes a drawing of the missile geometry with dimensions, aerodynamic coefficients and derivatives, center of pressure location, flight performance parameters (velocity, trim angle of attack, acceleration, range, trim control surface deflection) versus time, and missile miss distance.

### **Tactical Missile Design (TMD) Spreadsheet.**

Another computer technique suitable for conceptual design is spreadsheet analysis. Figure 9 shows the design parameters of the Tactical Missile Design (TMD) Spreadsheet. The TMD Spreadsheet runs in Windows on a PC. It has modules that follow the conceptual missile design tasks outlined in the figure. Based on external mission requirements (e.g., maximum range, minimum range, average velocity, measures of merit, and constraints), a baseline design is selected from the baseline missile spreadsheet module. Currently there are two possible baselines: a rocket powered missile, similar to the Sparrow AIM-7 missile, and a ramjet missile. The configuration, subsystem, and flight performance characteristics of the ramjet missile baseline were illustrated previously in Figure 5. The rocket missile baseline has a similar level of detail in its configuration, subsystem, and flight performance data.

Following the definition of mission requirements and the selection of a baseline configuration in the baseline spreadsheet module, the aerodynamics spreadsheet module is exercised. The aerodynamics spreadsheet module calculates zero-lift drag coefficient, normal force coefficient, aerodynamic center location, pitching moment control effectiveness, lift-to-drag ratio, and the required tail stabilizer surface area. The output data from the aerodynamics spreadsheet module, along with other default data from the baseline missile, are input into a propulsion spreadsheet module. The methodology used to calculate the aerodynamics of a missile body are based on slender body theory for the linear low angle of attack contribution and blended with cross flow theory at high angles of attack. It is applicable for all angles of attack, from zero to 180 degrees. The method used in calculating aerodynamics of missile fixed surfaces (e.g., wings, strakes, stabilizers) and movable surfaces (e.g., canards, tails) is based on linear wing and slender wing theory at low angle of attack and blended with Newtonian impact theory at high angles of attack.

The propulsion spreadsheet module provides an estimate of powered range, velocity, thrust, and specific impulse. For a ramjet, the output also includes total pressure recovery in the inlet. Rocket motor thrust and specific impulse are based on the isentropic flow equations, adjusted for the change in specific heat ratio with temperature. Incremental velocity and range are based on the one-degree of freedom equation of motion. The ramjet thrust and specific impulse predictions include the forebody and cowl oblique shocks and the inlet normal shock losses in total pressure.

After redesigning the aerodynamic configuration and propulsion system, a weight spreadsheet is used to revise the missile weight. The weight spreadsheet module includes an estimate of aerodynamic heating, surface temperature versus time, required airframe and motor case thickness, buckling stress, bending moment, motor case stress, and the density/weight of subsystems. Missile system weight scaling is provided by the density relationship, diameter, and length. Scaling of the weights of subsystems is provided by the density and volume relationships. Material data (e.g., density, stress-strain versus temperature) are also provided. Predictions are made of aerodynamic heating and surface temperature rate. Finally, missile body buckling stresses due to bending moment and axial loads, motor case stress, and required motor case thickness are calculated.

The flight trajectory spreadsheet module has analytical expressions for one degree and two degrees of freedom trajectories. The output includes flight range, thrust required for steady flight, steady climb velocity, steady dive velocity, turn radius, velocity and range at the end of boost, velocity and range at the end of coast, seeker lead angle for proportional homing guidance, required launch range, missile time of flight, and F-pole range. Flight trajectory methods are based on closed-form analytical methods. Cruise range prediction is based on



the Breguet range equation. Thrust required is estimated for steady cruise, steady climb, and steady dive. Turn radius, boost and coast velocity, boost and coast range, missile homing lead angle, launch range, and F-pole range (relative range between the launch platform and the target when the missile impacts the target) are also calculated.

Finally, the designer compares the output of the flight trajectory spreadsheet module against mission flight performance requirements. If the missile design does not meet the flight performance requirements, the process is repeated until the requirements are satisfied. The modularity of the spreadsheet and the default baseline missile data allow the designer to easily modify the input for the next iteration.

Once flight performance requirements are met, the measures of merit and constraints are then evaluated. The measures of merit spreadsheet module calculates parameters for warhead lethality, miss distance, survivability, and cost. Output parameters for the warhead lethality include warhead blast pressure, kill probability, number of warhead fragments impacting the target, warhead fragment velocity, kinetic energy warhead penetration, and missile kinetic energy impacting the target for hit-to-kill missiles. Output parameters for the missile miss distance include missile time constant, missile miss distance due to heading error, and missile miss distance due to a maneuvering target. Output parameters for the missile survivability include detection range. Finally, the output parameters for missile cost include missile production cost due to weight and missile production cost due to the learning curve.

Again, the missile design is iterated until the measures of merit and constraints (such as launch platform integration) are satisfied.

Verification of the TMD Spreadsheet was based on comparing the source code with the equations from the Tactical Missile Design textbook, comparing results with the ADAM code, and also comparing the results with the examples in the Tactical Missile Design textbook. The rocket and ramjet baselines, which are based on test data, were used in the verification of the TMD Spreadsheet.

## **Configuration Conceptual Design Sizing Criteria**

Table 1 shows conceptual design configuration sizing criteria. The table has fourteen configuration design criteria related to the areas of flight performance and guidance & control. Configuration design criteria related to flight performance include missile body fineness ratio, nose fineness ratio, boattail ratio, cruise dynamic pressure, missile homing velocity, ramjet combustion temperature, oblique shocks prior to the inlet normal shock, and inlet spillage. A design criterion for the missile body fineness ratio (length-to-diameter ratio) is that it should be between 5 and 25, to harmonize tradeoffs of drag, subsystem packaging available volume, launch platform integration, seeker and warhead effectiveness, and body bending. The nose fineness (nose length-to-diameter ratio) for supersonic missiles should be approximately two to avoid high drag at high speed without degrading seeker performance. Boattail diameter ratio (boattail diameter-to-maximum missile diameter ratio) should be greater than 0.6 for supersonic missiles to avoid increased drag at high speed. A design criterion for efficient cruise flight is that the dynamic pressure be less than 1,000 pounds per square foot. Missile velocity should be at least 50 percent greater than the target velocity to capture the target. Ramjet combustion temperature should be greater than 4,000 degrees Fahrenheit for high specific impulse and thrust at Mach number greater than 3.5. Efficient inlet integration for supersonic missiles requires at least one oblique shock prior to the inlet normal shock, for good inlet total pressure recovery at Mach numbers greater than 3.0. For Mach numbers greater than 3.5, at least two oblique shocks prior to the inlet normal shock are desirable for inlet total pressure recovery. Finally, the forebody shock wave should impact the inlet cowl lip at the highest Mach number cruise condition, to minimize the spillage drag at lower Mach number.

Configuration design criteria related to guidance & control include the flight control actuator frequency, trim control power, stability & control derivatives cross coupling, airframe time constant, missile maneuverability, and proportional guidance ratio. Body bending frequency in the first mode should be greater than twice the flight control actuator frequency if possible, to avoid the complication and risk of notch filters. Trim control power (trim angle of attack-to-control surface deflection ratio) should be greater than 1 for maneuverability. Stability & control derivatives cross coupling should be less than 30 percent for efficient dynamics. The

missile airframe time constant should be less than 0.2 second for precision accuracy (3 meters). Contributors to a low value of the airframe time constant include high maneuverability capability, neutral static margin, high rate control surface actuators, low dome error slope, and a low noise seeker. Missile maneuverability should be at least three times the target maneuverability, for small miss distance. Finally, the proportional guidance ratio should be between 3 and 5 to minimize miss distance. Values less than 3 result in excessive time to correct heading error, while values greater than 5 make the missile overly sensitive to noise input from the seeker and the dome error slope.

## Summary/Conclusions

Missile design is a creative and iterative process that includes system-of-systems considerations, missile sizing, and flight trajectory evaluation. Because many of the cost and performance drivers may be “locked in” early during the design process, the emphasis of this text has been on conceptual design.

Missile design is an opportunity to harmonize diverse inputs early in the missile development process. The military customer, operations analysts, system integration engineers, conceptual design engineers, technical specialists, and others work together in harmonizing the mission/scenario definition, system-of-systems requirements, launch platform integration, missile concept synthesis, and technology assessment/roadmaps.

Missile conceptual design is a highly integrated process requiring synergistic compromise and tradeoffs of many parameters. The synthesis of an effective compromise requires balanced emphasis in subsystems, unbiased tradeoffs, and the evaluation of many alternatives. It is important to keep track of assumptions to maintain traceable results. Starting with a well-defined baseline that has similar propulsion and performance expedites design convergence and provides a more accurate design.

Conceptual design is an open-ended problem and has no single right answer. The available starting point information is never sufficient to provide only one solution. The design engineer makes assumptions in coming up with candidate concepts, subsystems, and technologies to satisfy mission requirements and cover the solution space. Weighting of the most important measures of merit is required in coming up with a cost-effective solution. The military customer buy-in is important in achieving a consensus weighting of the most important measures of merit. Trade studies are conducted to investigate the impact of design parameters. Sensitivity analyses are also conducted to evaluate the effects of uncertainty in the design and the benefit of new technology. The missile is designed for robustness to handle risk and uncertainty of both a deterministic and a stochastic nature.

Finally, a good conceptual design code is a physics-based code that connects the missile geometric, physical, and subsystem performance parameters directly into a flight trajectory evaluation. Good conceptual design codes do not automatically change the design or resize automatically. It is best that the missile designer make the creative decisions.

## Bibliography of Missile Design Related Reports

### System Design

Fleeman, E.L., *Tactical Missile Design*, American Institute of Aeronautics and Astronautics, Washington D.C., 2001.

Hindes, J.W., “Advanced Design of Aerodynamic Missiles (ADAM),” October 1993.

Bithell, R.A., and Stoner, R.C., “Rapid Approach for Missile Synthesis,” AFWAL TR 81-3022, Vol. I, March 1982.

Jerger, J.J., *Systems Preliminary Design Principles of Guided Missile Design*, D. Van Nostrand Company, Inc., Princeton, New Jersey, 1960.

“Missile.index,” [http://www.index.ne.jp/missile\\_e/](http://www.index.ne.jp/missile_e/).

AIAA Aerospace Design Engineers Guide, American Institute of Aeronautics and Astronautics, 1993.

Chin, S.S., *Missile Configuration Design*, McGraw-Hill Book Company, New York, 1961.

- Kinroth, G.D. and Anderson, W.R., "Ramjet Design Handbook," CPIA Publication 319 and AFWAL TR 80-2003, June 1980.
- Mason, L.A., Devan, L., and Moore, F.G., "Aerodynamic Design Manual for Tactical Weapons," NSWCTR 81-156, 1981.
- Schneider, S.H., *Encyclopedia of Climate and Weather*, Oxford University Press, 1996.
- Klein, L.A., *Millimeter-Wave and Infrared Multisensor Design and Signal Processing*, Artech House, Boston, 1997.
- Nicholas, T. and Rossi, R., "US Missile Data Book, 1996," Data Search Associates, 1996.
- Fleeman, E.L. and Donatelli, G.A., "Conceptual Design Procedure Applied to a Typical Air-Launched Missile," AIAA 81-1688, August 1981.
- Nicolai, L.M., "Designing a Better Engineer," AIAA Aerospace America, April 1992.
- Ashley, H., *Engineering Analysis of Flight Vehicles*, Dover Publications, New York, 1974.
- "Missile System Flight Mechanics," AGARD CP270, May 1979.
- Hogan, J.C., et al., "Missile Automated Design (MAD) Computer Program," AFRPL TR 80-21, March 1980.
- Rapp, G.H., "Performance Improvements With Sidewinder Missile Airframe," AIAA Paper 79-0091, January 1979.
- Nicolai, L.M., *Fundamentals of Aircraft Design*, METS, Inc., San Jose, CA, 1984.
- Lindsey, G.H. and Redman, D.R., "Tactical Missile Design," Naval Postgraduate School, 1986.
- Lee, R. G., et al, *Guided Weapons, Third Edition*, Brassey's, London, 1998.
- Giragosian, P.A., "Rapid Synthesis for Evaluating Missile Maneuverability Parameters," 10th AIAA Applied Aerodynamics Conference, June 1992.
- Fleeman, E.L. "Aeromechanics Technologies for Tactical and Strategic Guided Missiles," AGARD Paper presented at FMP Meeting in London, England, May 1979.
- Raymer, D.P., *Aircraft Design, A Conceptual Approach*, American Institute of Aeronautics and Astronautics, Washington D.C., 1989.
- Ball, R.E., *The Fundamentals of Aircraft Combat Survivability Analysis and Design*, American Institute of Aeronautics and Astronautics, Washington D.C., 1985.
- Eichblatt, E.J., *Test and Evaluation of the Tactical Missile*, American Institute of Aeronautics and Astronautics, Washington D.C., 1989.
- "DoD Index of Specifications and Standards," [http://www.dtic.mil/stinet/str/dodiss4\\_fields.html](http://www.dtic.mil/stinet/str/dodiss4_fields.html).
- "Periscope," <http://www.periscope.usni.com>.
- Defense Technical Information Center, <http://www.dtic.mil/>.
- "Aircraft Stores Interface Manual (ASIM)," <http://www.asim.net>.
- "Advanced Sidewinder Missile AIM-9X Cost Analysis Requirements Description (CARD)," <http://web2.deskbook.osd.mil/valhtml/2/2B/2B4/2B4T01.htm>.

## Aerodynamics

- "Technical Aerodynamics Manual," North American Rockwell Corporation, DTIC AD 723823, June 1970.
- Oswatitsch, K., "Pressure Recovery for Missiles with Reaction Propulsion at High Supersonic Speeds", NACA TM - 1140, 1948.
- Pitts, W.C., Nielsen, J.N., and Kaattari, G.E., "Lift and Center of Pressure of Wing-Body-Tail Combinations at Subsonic, Transonic, and Supersonic Speeds," NACA Report 1307, 1957.
- Jorgensen, L.H., "Prediction of Static Aerodynamic Characteristics for Space-Shuttle-Like, and Other Bodies at Angles of Attack From 0° to 180°," NASA TND 6996, January 1973.
- Hoak, D.E., et al., "USAF Stability and Control Datcom," AFWAL TR-83-3048, Global Engineering Documents, Irvine, CA, 1978.
- "Nielsen Engineering & Research (NEAR) Aerodynamic Software Products," <http://www.nearinc.com/near/software.htm>.
- Briggs, M.M., *Systematic Tactical Missile Design, Tactical Missile Aerodynamics: General Topics*, "AIAA Vol. 141 Progress in Astronautics and Aeronautics," American Institute of Aeronautics, Washington, D.C., 1992.
- Briggs, M.M., et al., "Aeromechanics Survey and Evaluation, Vol. 1-3," NSWC/DL TR-3772, October 1977.
- "Missile Aerodynamics," NATO AGARD LS-98, February 1979.
- "Missile Aerodynamics," NATO AGARD CP-336, February 1983.
- "Missile Aerodynamics," NATO AGARD CP-493, April 1990.
- "Missile Aerodynamics," NATO RTO-MP-5, November 1998.

- Nielsen, J.N., *Missile Aerodynamics*, McGraw-Hill Book Company, New York, 1960.
- Mendenhall, M.R. et al, "Proceedings of NEAR Conference on Missile Aerodynamics," NEAR, Mountain View, CA, 1989.
- Nielsen, J.N., "Missile Aerodynamics – Past, Present, Future," AIAA Paper 79-1818, 1979.
- Dillenius, M.F.E., et al, "Engineering-, Intermediate-, and High-Level Aerodynamic Prediction Methods and Applications," *Journal of Spacecraft and Rockets*, Vol. 36, No. 5, September-October, 1999.
- Nielsen, J.N., and Pitts, W.C., "Wing-Body Interference at Supersonic Speeds with an Application to Combinations with Rectangular Wings," NACA Tech. Note 2677, 1952.
- Burns, K. A., et al, "Viscous Effects on Complex Configurations," WL-TR-95-3060, 1995.
- "A Digital Library for the National Advisory Committee of Aeronautics," <http://naca.larc.gov>.
- Spreiter, J.R., "The Aerodynamic Forces on Slender Plane-and Cruciform-Wing and Body Combinations", NACA Report 962, 1950.
- Bruns, K.D., Moore, M.E., Stoy, S.L., Vukelich, S.R., and Blake, W.B., "Missile Datcom," AFWAL-TR-91-3039, April 1991.
- Moore, F.G., et al, "Application of the 1998 Version of the Aeroprediction Code," *Journal of Spacecraft and Rockets*, Vol. 36, No. 5, September-October 1999.

### Propulsion

- Cox, H.H. "Internal Aerodynamics," North American Aircraft Lecture Course, April 1968.
- Mahoney, J.J., *Inlets for Supersonic Missiles*, American Institute of Aeronautics and Astronautics, Washington, D.C., 1990.
- Sutton, G.P., *Rocket Propulsion Elements*, John Wiley & Sons, New York, 1986.
- Bonney, E.A., et al, "Propulsion, Structures and Design Practice," *Principles of Guided Missile Design*, D. Van Nostrand, Princeton, NJ, 1956.
- "Tri-Service Rocket Motor Trade-off Study, Missile Designer's Rocket Motor handbook," CPIA 322, May 1980.
- Chemical Information Propulsion Agency, <http://www.jhu.edu/~cpia/index.html>.

### Materials

- Budinski, K.G. and Budinski, M.K., *Engineering Materials Properties and Selection*, Prentice Hall, New Jersey, 1999.
- "Matweb's Material Properties Index Page," <http://www.matweb.com>.
- "NASA Ames Research Center Thermal Protection Systems Expert (TPSX) and Material Properties Database", <http://tpsx.arc.nasa.gov/tpsxhome.shtml>.

### Guidance & Control

- Zarchan, P., *Tactical and Strategic Missile Guidance*, "AIAA Vol. 124 Progress in Astronautics and Aeronautics," American Institute of Aeronautics and Astronautics, Washington D.C., 1990.
- "Proceedings of AGARD G&C Panel Conference on Guidance & Control of Tactical Missiles," AGARD LS-52, May 1972.
- Heaston, R.J. and Smoots, C.W., "Precision Guided Munitions," GACIAC Report HB-83-01, May 1983.
- Donatelli, G.A. and Fleeman, E.L., "Methodology for Predicting Miss Distance for Air Launched Missiles," AIAA-82-0364, January 1982.
- Bennett, R.R. and Mathews, W.E., "Analytical Determination of Miss Distances for Linear Homing Navigation Systems," Hughes Tech Memo 260, 31 March 1952.

### Warhead

- US Army Ordnance Pamphlet ORDP-20-290-Warheads, 1980.
- Carleone, J. (Editor), *Tactical Missile Warheads*, "AIAA Vol. 155 Progress in Astronautics and Aeronautics," American Institute of Aeronautics and Astronautics, Washington, D.C., 1993.
- Christman, D.R. and Gehring, J.W., "Analysis of High-Velocity Projectile Penetration Mechanics," *Journal of Applied Physics*, Vol. 37, 1966.

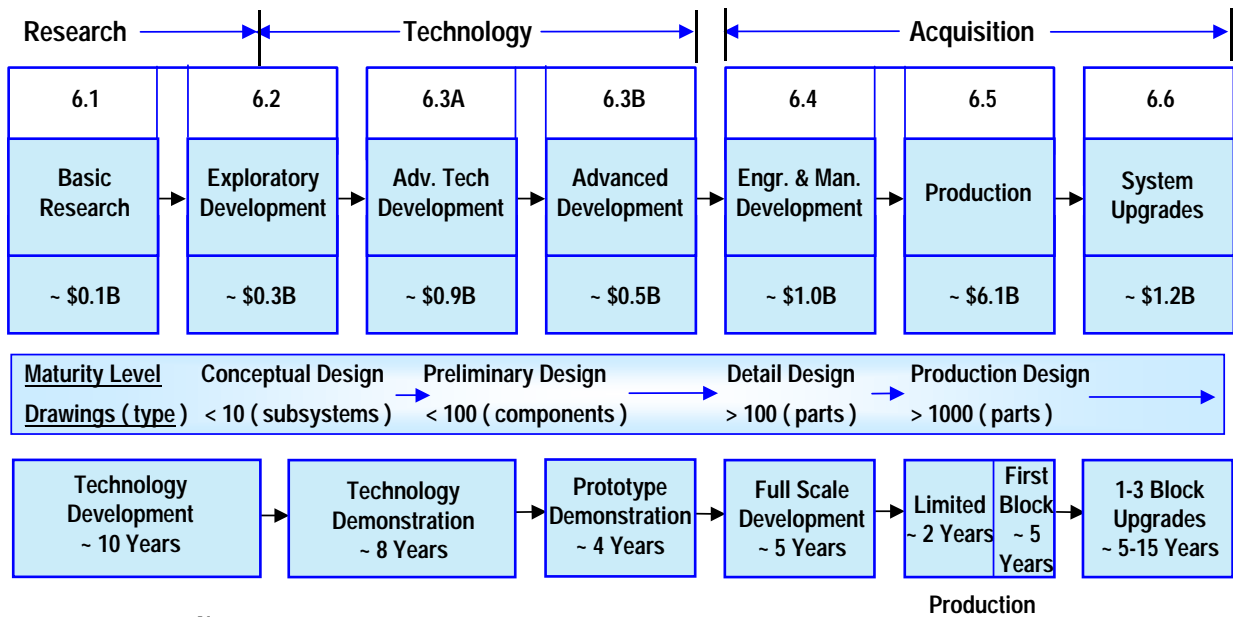



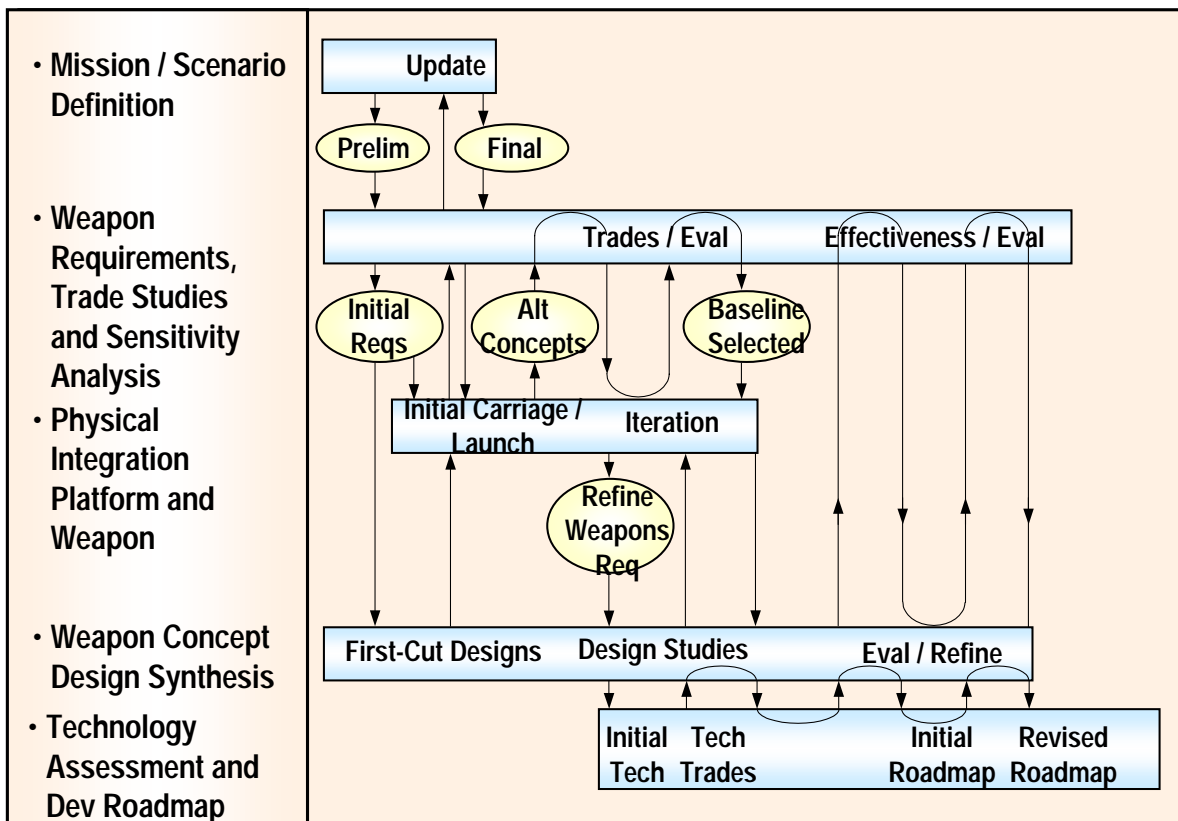

Note:  
 Total US DoD Research and Technology for Tactical Missiles ≈ \$1.8 Billion per year  
 Total US DoD Acquisition ( EMD + Production + Upgrades ) for Tactical Missiles ≈ \$8.3 Billion per year  
 Tactical Missiles ≈ 11% of U.S. DoD RT&A budget  
 US Industry IR&D typically similar to US DoD 6.2 and 6.3A

Figure 1. Relationship of Level of Design to the Research, Technology, and Acquisition Process.

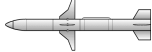

Note: Typical design cycle for conceptual design is usually 3 to 9 months

Figure 2. Conceptual Design of Precision Strike Missiles Requires Iteration.

Weapon		Fixed Surface Targets <sup>(1)</sup>	Moving Targets <sup>(2)</sup>	Time Critical Targets <sup>(3)</sup>	Buried Targets <sup>(4)</sup>	Adverse Weather <sup>(5)</sup>	Firepower <sup>(6)</sup>
 Example New Missile		●	●	●	●	●	◐
 AGM-65		●	○	○	○	-	○
 Small Smart Bomb		●	-	-	●	●	●
 AGM-88		●	-	●	-	●	-
 Hellfire / Brimstone / Longbow		○	●	○	-	●	●
 LOCAAS		○	●	-	-	○	●

(1) - Large warhead desired. GPS / INS provides precision ( 3 meter) accuracy.

(2) - Seeker required for terminal homing.

(3) - High speed required ⇒ High payoff of rocket or ducted rocket propulsion and low drag.

(4) - Kinetic energy penetration required ⇒ High impact speed ⇒ High payoff of low drag and long length.

(5) - GPS / INS, SAR seeker, and imaging mmW seeker have high payoff

(6) - Light weight required. Light weight also provides low cost

**Note:**

- Superior
- ◐ Good
- Average
- Poor

**Figure 3. Examples of Design Alternatives for Light Weight Precision Strike Missiles.**

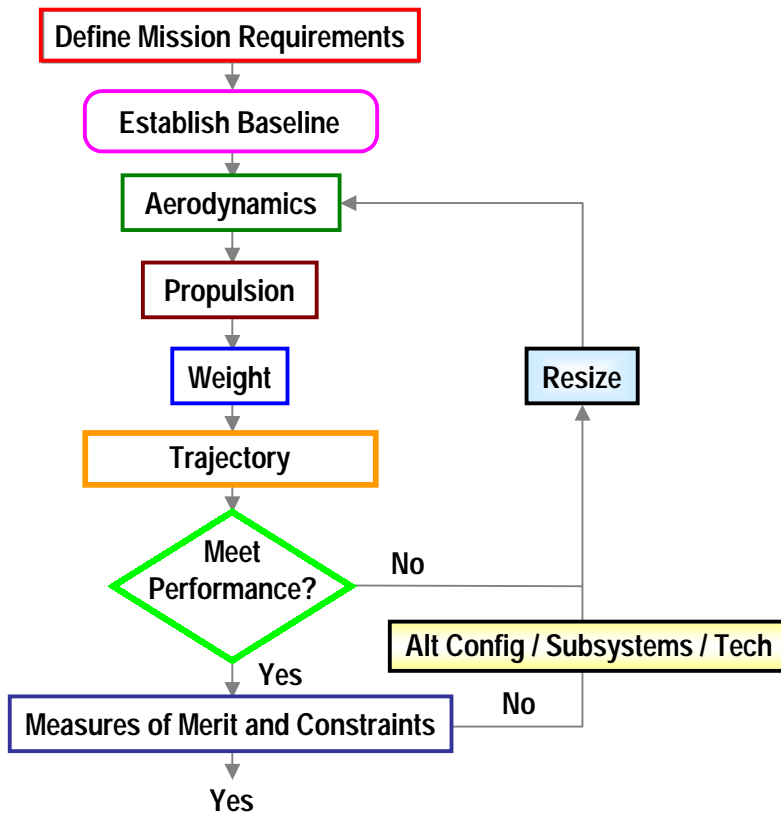

**Figure 4. Missile Concept Synthesis Requires Iteration.**

### Configuration Drawing

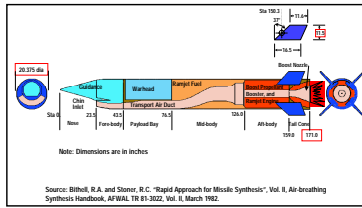

### Weight / Geometry

Condition	Weight lb	CG Sta in
Nose	16.9	16.7
Canards	122.0	111.1
Propellant	144.2	88.0
Main Wing	100.0	89.0
Wingtip Fuel	85.2	88.2
Electrical	28.0	112.0
Control	19.0	111.0
Fuel Distribution	0.0	111.0
Altitude	16.5	141.5
Tailcone	21.0	168.0
Exit Cone	21.0	168.0
Control	27.0	168.0
Flare	13.0	157.0
Ballistic Data (L&S)	436.8	81.8
Ball of Charge	4.368	158.0
Ball of Charge (Empty)	21.0	158.0
Propellant	11.0	158.0
Ball of Charge	1.761	84.0
Ball of Charge	488.8	161.0
Ball of Charge	2,205.1	91.0

### Flow Path Geometry

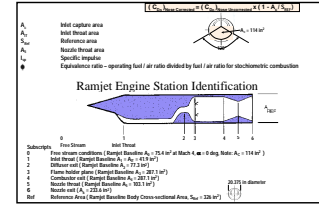

### Aerodynamics

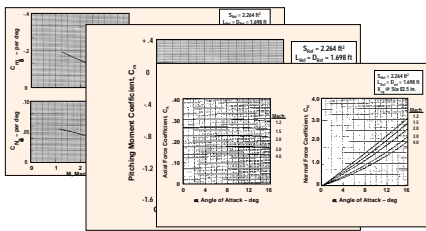

### Ramjet Propulsion

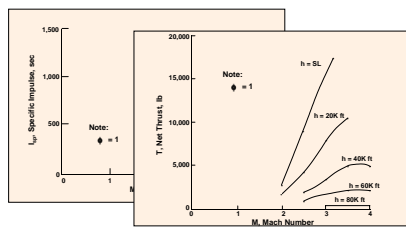

### Rocket Propulsion

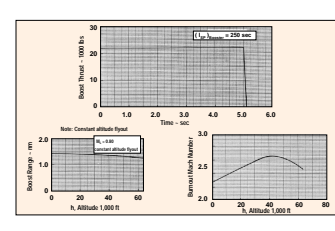

### Flight Performance

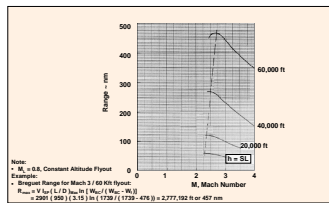

### Range Sensitivity

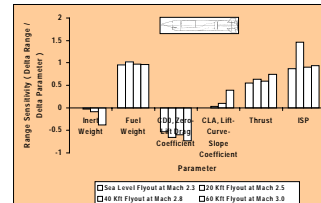

Figure 5. Example of Precision Strike Missile Baseline Data.

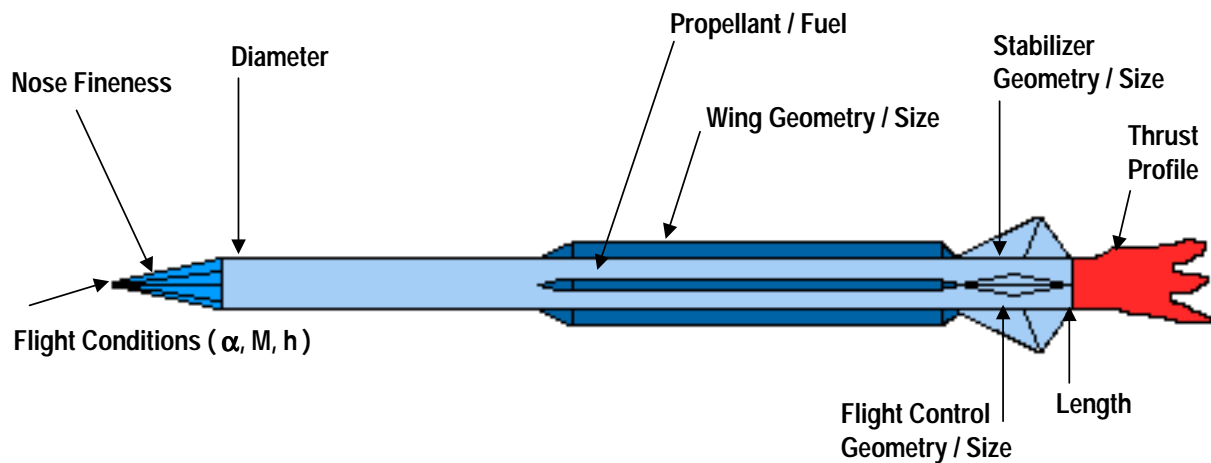

Figure 6. Aerodynamic Configuration Sizing Parameters.

◆ Conceptual Design Modeling

- ◆ 1 DOF ( Axial force (  $C_{D0}$  ), thrust, weight )
- ◆ 2 DOF ( Normal force (  $C_N$  ), axial force, thrust, weight )
- ◆ 3 DOF point mass ( 3 forces ( normal, axial, side ), thrust, weight )
- ◆ 3 DOF pitch ( 2 forces ( normal, axial ), 1 moment ( pitch ), thrust, weight )
- ◆ 4 DOF ( 2 forces ( normal, axial ), 2 moments ( pitch, roll ), thrust, weight )

◆ Preliminary Design Modeling

- ◆ 6 DOF ( 3 forces ( normal, axial, side ), 3 moments ( pitch, roll, yaw ), thrust, weight )

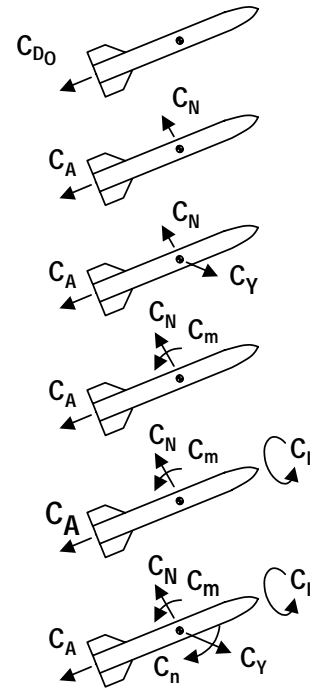
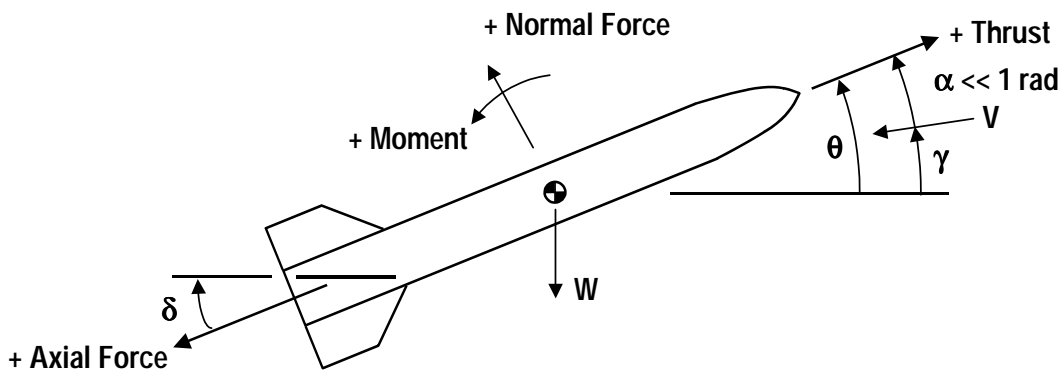

Figure 7. Conceptual Design Uses Simple Modeling of the Missile System.



Configuration Sizing Implication

$$I_y \theta'' \approx q S d C_{m_\alpha} \alpha + q S_{Ref} d C_{m_\delta} \delta$$

High Control Effectiveness  $\Rightarrow C_{m_\delta} > C_{m_\alpha}$ ,  $I_y$  small (  $W$  small ),  $q$  large

$$(W / g_c) V \dot{\gamma} \approx q S C_{N_\alpha} \alpha + q S C_{N_\delta} \delta - W \cos \gamma$$

Large / Fast Heading Change  $\Rightarrow C_N$  large,  $W$  small,  $q$  large

$$(W / g_c) V' \approx T - C_A S q - C_{N_\alpha} \alpha^2 S q - W \sin \gamma$$

High Speed / Long Range  $\Rightarrow$  Total Impulse large,  $C_A$  small,  $q$  small

Figure 8. 3DOF Simplified Equations of Motion Show Drivers for Missile Configuration Sizing.



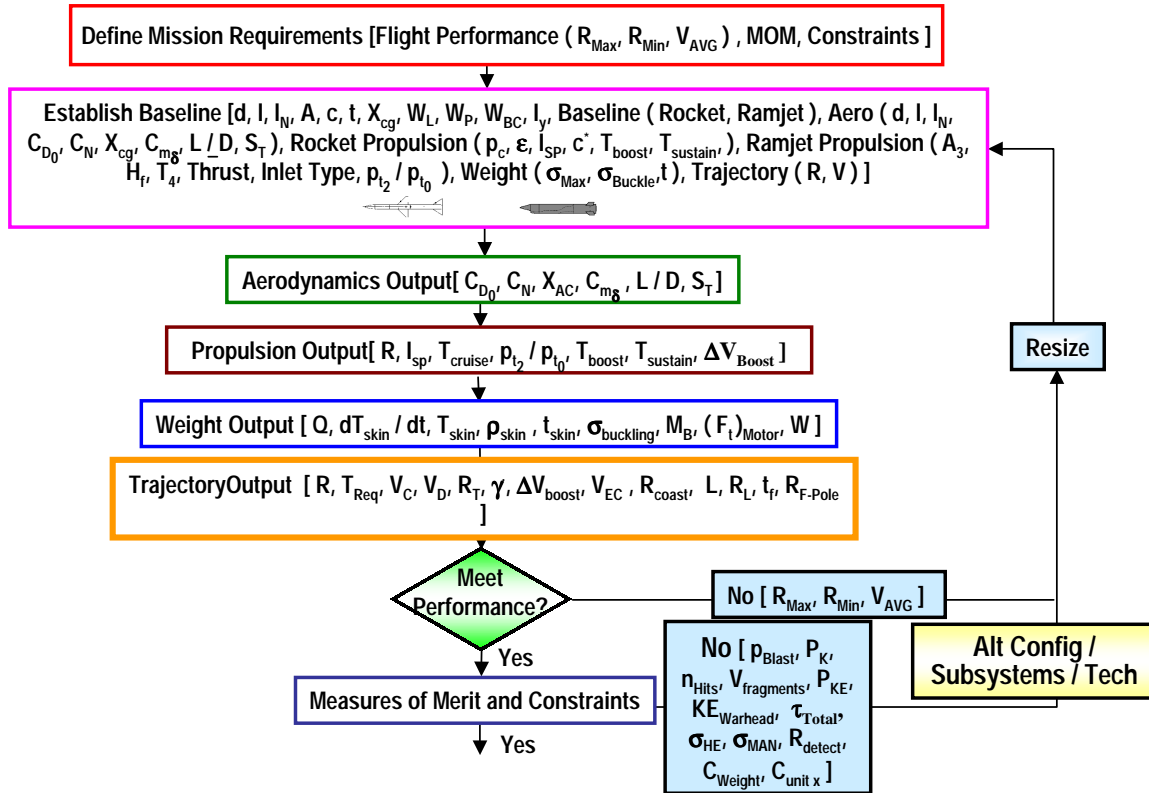

Figure 9. Tactical Missile Design (TMD) Spreadsheet Parameters.

Table 1. Precision Strike Missile Configuration Design Criteria.

Configuration Sizing Parameter	Design Criteria
◆ Flight Performance Related	
◆ Body fineness ratio	$5 < l / d < 25$
◆ Nose fineness ratio	$l_N / d \approx 2$ if $M > 1$
◆ Boattail diameter ratio	$0.6 < d_B / d_{Ref} < 1.0$
◆ Cruise dynamic pressure	$q < 1,000$ psf
◆ Missile homing velocity	$V_M / V_T > 1.5$
◆ Ramjet combustion temperature	$> 4,000$ degrees Fahrenheit
◆ Oblique shocks prior to inlet normal shock	$> 1$ oblique shock if $M > 3.0$ , $> 2$ if $M > 3.5$
◆ Inlet spillage	Shock on cowl lip at $M_{max}$ cruise
◆ Guidance & Control Related	
◆ Body bending frequency	$\omega_{BB} > 2\omega_{ACT}$
◆ Trim control power	$\alpha / \delta > 1$
◆ Stability & control cross coupling	$< 30\%$
◆ Airframe time constant	$\tau < 0.2$ sec
◆ Missile maneuverability	$n_M / n_T > 3$
◆ Proportional guidance ratio	$3 < N' < 5$

**This page has been deliberately left blank**



**Page intentionnellement blanche**

# Missile Seekers for Strike Warfare Beyond the Year 2000

**William H. Licata**

Senior Principal Systems Engineer  
3590 New Heritage Drive  
Alpharetta, Ga 30022 US  
[770-475-2318/protono@ieee.org](mailto:770-475-2318/protono@ieee.org)

## Abstract

The goal of this paper is to explore emerging post Cold War missile seeker requirements that will lead to new seeker procurements in the year 2000+. These requirements are compared to existing missile seeker products to show where technology deficiencies exist. A projection is made of what seekers will be deployed in the near future to fill important military missile user needs and where technology investments will be made to develop fully capable missile seekers. The orientation of the presentation is on missile seekers as a product and the functionality they provide the military user community. Therefore, the presentation discusses new functionality not included in seekers built in the 1900's because of technology limitations or lack of sufficient user requirements.

## Introduction

The 1900's has brought the development of precision munitions and established a base for major improvements in missile seekers during the next millenium. This paper addresses what new missile seekers will enter military inventory during the first part of the new millenium based on developing post cold war requirements for missile seekers. This paper will focus on what the author believes are a few key requirements that will drive missile seeker developments and technology investments. Missile seekers will be viewed more from a product and customer need prospective rather than a technology perspective.

## Flying Into The New Millenium

At the end of this millenium, technology appears to be king and advances appear to move at a very rapid pace. Commercial technology truly appears to be flying into the next millenium. Major advances in military technology are equally impressive although held back some by a post cold war restructuring of the military/industrial complex. This restructuring raises questions not only about what the mission of the military will be in the early part of the new millenium and what equipment fills that need but how industry makes a profit and stays solvent in a shrinking market. Figure 1 illustrates this pivotal time in military history and the need to adjust rapidly to a world going through major military and geopolitical changes. In spite of the many uncertainties, there are new requirements emerging for a new generation of more capable missile seekers which industry will have to fill in a more economical fashion than in the past. Because commercial technology appears to be moving at a faster pace than military technology, filling these needs more economically may require finding a way to exploit commercial products without major compromises in military preparedness.

## Seeker Functions

The reason a seeker is put in a missile is because there is uncertainty in the missile launch point, flight path or target location that makes it impossible to achieve the desired accuracy without a seeker. For some targets and bomb sizes, GPS accuracy is sufficient and a seeker is not required to satisfy mission objectives. Seekers can also provide autonomy allowing the launch aircraft to move out of the range of air defenses or move to the

next target more rapidly. It is helpful to keep this functionality in mind when reviewing requirements and the needs for new seekers.

A new developing seeker function is real time, bomb impact reporting that helps determine the need for a second weapon on target. Since an increasing number of seekers are imaging seekers, the potential exists to transmit the pictures back to the launch aircraft or support aircraft just prior to weapon impact. This doesn't verify warhead detonation but verifies correct aimpoint selection. Depending on the reliability of the fuse and warhead, bomb detonation can be assumed to have occurred.

## **Changing Seeker Requirements**

In the opinion of the author seeker requirements have and will change dramatically during the next millenium in many mission areas as illustrated in Figure 2. Seekers built during the 1900s were designed for major world wars rather than small wars with a high likelihood of friendly forces intermixed with enemy forces or weapons of mass destruction hidden in civilian areas.

New seeker requirements include antistealth, hit-to-kill at an affordable price, and in the area of strike warfare both the Desert Storm and Kosovo operations demonstrated the need to attack through the clouds and engage targets autonomously. Filling these newer and in some cases older requirements with technology that may finally have reached the required level of maturity will be a high priority task of military planners.

## **Impact of GPS on Missile Seekers**

The introduction of GPS has had an impact on missile seeker developments and is worthy of some discussion but the impact is not what some military planners hoped it would be. Some military planners hoped that GPS would reduce seeker requirements, and therefore, reduce the procurement cost of seekers. To some extent they have reduced fixed target search requirements but this hasn't had a major impact on seeker costs. GPS has had a major impact on dumb bombs by providing a way of reducing their dispersion through the introduction of INS/GPS tailkits and perhaps the final days of dumb bombs will come to pass.

Figure 3 illustrates what the author sees as the real impact of GPS on seekers for mission areas such as strike warfare. First the introduction of an INS/GPS has meant that the INS becomes the source of high rate autopilot commands instead of the seeker providing high bandwidth line-of-sight rate information. The seeker becomes a low rate navigation update device to the INS. This gives imaging systems and ATR systems more time to perform their processing, relaxing throughput requirements on the ATR. Fixed target ATR is clearly reduced since the ATR knows the precise approach range and angles.

A final point about GPS is its use in the military strategic and tactical mission areas plus commercial applications. The use of GPS to guide weapons means any attempt to negate the effectiveness of GPS is a threat to all three of these communities and perhaps the commercial application is the one of greatest value to the voting public. Attempts to destroy GPS satellites could also raise a conflict to the level of nuclear warfare.

## **Future Investments, Technology Thrusts and New Products**

Future investments leading to new technologies and products will be driven as always by those needs the military decides have the highest priority modified some by political considerations as illustrated in Figure 4. Figure 4 lists some needs the author believes military planners have or will decide are a high priority such as cloud penetration or high impact angle in the area of strike warfare. In the current technology base are E/O and radar seekers of various forms and in the research base are some new types such as imaging passive MMW plus multisensor. Cloud penetration will create a need for a radar seeker of some form. In the authors opinion, this is most likely a synthetic aperture radar seeker and this will drive industry to invest in affordable SAR designs through lean manufacturing, certified suppliers and use of commercial products. These initial radar designs will have to develop solutions for the high impact angle requirement since radars have difficulties when transmitting straight into the ground.

As figure 5 illustrates, there is a need for each type of seeker depending on the mission area. Each of these developments compete for the same pool of production dollars.

National Missile Defense (NMD) may have the higher nation priority but it is limited by treaty restrictions. NMD may receive most of the technology investment forcing industry to pick up some of the technology investments required to move new strike warfare seekers into the military inventory. Antistealth by the nature of the difficulty of the problem may remain an unfilled need or approached from directions other than new seekers. Antistealth will be an area for continuous research investments.

### **Cloud Penetration Problem**

Performing the trade studies to select a seeker for a mission where the target area is covered by clouds involves several factors as illustrated by Figures 6. Obviously the sensors ability to see through the clouds is a key factor. As shown at the top of Figure 6, radar seekers have a clear advantage over E/O seekers that are cloud blind. If all targets can be approached at shallow angles such as bridges and industrial buildings, a radar seeker would be a clear winner. Some targets need to be attacked from high approach angles and radars have difficulties once the approach angle gets close to vertical. Near vertical, radar functions more like an altimeter than a traditional radar seeker and range resolution doesn't separate targets from ground clutter. E/O seekers function equally well at high and low depression angles but don't see through the clouds. For these different reasons, both types of seekers are forced to either pop under the clouds and pop up to increase impact angle or just blast through the clouds at a high impact angle. Both approaches have their problems. The SAR can pick an aimpoint at long range and fly inertial to the high impact angle but this stresses the INS to hold the accurate long range fix and drives up the cost of the INS system.

### **Future Radar Seeker Developments**

Many military planners hoped that radar seekers for strike warfare could be fielded in the 1900s and several good attempts were made to achieve this goal such as the MMW Maverick program. For many reasons, this goal must be met in the new millenium. There are three basic technologies that could fill this need and they are called out in Figure 7 as Active & Passive MMW or SAR. Passive MMW using arrays of detectors is still in the early stages of development but progressing quickly. Until a mature producible camera including auto calibration enters the market place it is unlikely that any Passive MMW seeker prototypes will be built. MMW has lost the resolution advantage of being at very high frequencies to SAR seekers that rely on the more affordable approach of high speed computer processing. MMW seekers will need longer detection range which means more transmitter power and more sensitive receivers plus new signal processing techniques to enhance resolution so it can compete against SAR for a Strike Warfare mission. MMW does retain the advantage that it can see the target at nose on aspects unlike SAR that must look to the side and fly a spiral trajectory and go blind at much longer ranges. If SAR seekers fail to prove that squint mode guidance can achieve high performance, active MMW may appear once again as the leading seeker contender. All active radar seekers must develop processing techniques compatible with high angle attack.

### **Future of Infrared Seekers**

Infrared seekers such as the JASSM seeker, will continue to be important in many Strike Warfare mission areas such as engaging relocatable targets which may often be targets of opportunity because of their minimum exposure time. Figure 8 shows trends in infrared seekers. In the next millenium uncooled infrared seekers will be fielded at a lower cost and with a longer shelf life than cooled seekers. Initially these seekers will fill a need for low performance/low cost seekers but their performance capabilities will grow and they will work their way into mission areas requiring high performance. Cooled detectors will have to offer more than low noise and high resolution. Cooled detector arrays will push for higher yields and greater uniformity to compete with uncooled detectors. Even more important cooled detector arrays are in a better position to offer multiple wavebands and on chip processing. Scene based calibration techniques will also slowly become a standard eliminating the need for expensive infrared calibration reference. The growing competition between uncooled and cooled arrays will accelerate forward improvements in both product areas.

## Missile Level Trades

In general seekers are looked at as receiving requirements that are flowed down from the missile level, but when cost is an independent variable, it may be appropriate to trade seeker performance for airframe performance as illustrated in Figure 9. Returning to the cloud penetration problem the minimum cloud ceiling that can be handled depends both on the seeker acquisition range and the maneuver capability of the airframe. The higher the airframe maneuverability, the longer the seeker can wait to acquire the target. In the case of moving targets, this directly effects the ability of the missile to stretch in order to catch a target that has moved away from the initial acquisition point. The next millenium may very well see a push for higher performance airframes as a way to reduce seeker requirements, stretch E/O seekers into the cloud penetration scenario or drop the minimum cloud ceiling which increases total number of operational days. Figure 10 shows the amount of airframe maneuverability required as a function of sensor acquisition range and target uncertainty. As sensor acquisition range shrinks because of decreasing cloud cover, the required missile maneuverability increases rapidly. Since the equation is basically  $.5at^2$  where a is maneuverability and t is time of flight, maneuverability increases inversely with the square of acquisition range (time of flight is acquisition range divided by missile speed).

## Synthetic Aperture Radar Attractive Adverse Weather Seeker

As already stated and shown in Figure 11, SAR is a leading contender for an adverse weather seeker for Strike Warfare. Its ability to provide a high resolution image in all weather at long ranges coupled by computers being the enabling technology make it hard to beat. Millimeter wave seekers that exploit shorter wavelength to achieve better resolution cannot achieve SAR resolution even at moderate ranges. The unanswered questions about SAR is the accuracy that can be achieved using squint mode guidance (missile spirals into the target) and the realizable average unit production prices that can be achieved using the current supplier base for radar components. There is also a question of whether current tactical grade IMUs required to compensate the SAR phase for missile motion are adequate to meet ATR image quality requirements. Once these questions are satisfactorily answered, a SAR production go ahead may be in the near future.

Figure 12 illustrates the subsystems that make up a SAR seeker. In many ways they don't differ from any radar seeker. One of the things that does differ is the quality of the components that are used in the subsystems. The waveform generator needs to be very linear with low phase noise. Fortunately modern missiles have inertial navigation systems which no longer get counted against the cost of the SAR which must have an INS for motion compensation. The biggest difference between a SAR and a MMW radar is the SAR processor since it must handle the complicated image format process and perform complex functions such as a 2-D fast Fourier transform. With modern computers, this is not only very possible in a small, affordable subassembly but it is likely to decrease in price over the life of the SAR seeker production life.

The emerging new Hit-to-Kill technology in the air defense arena, as illustrated in Figure 13, may also find its way to Strike Warfare for similar reasons that make it attractive to the air defense community. Hit to kill means reducing the seeker line of sight measurement error to sufficiently small numbers that the missile hits a lethal aimpoint on the target.

Combining air defense hit to kill technology with ATR may fill an important gap in Strike Warfare reducing collateral damage associated with destroying some weapons of mass destruction, and potentially reducing weapon cost. This will become increasingly possible as the air defense community reduces the price of ownership by maturing the technology, developing a mature supplier base and validating production processes.

## Stealth

Stealth has received so much publicity that it must be considered for two reasons. Strike warfare needs to be aware of what steps the enemy may take to defeat stealth and ground force may develop their own stealth techniques to protect themselves from precision bombing. Some factories have already gone underground becoming stealthy. Relocatable targets hide in holes in the ground for stealth. As Figure 14 states, stealth is

associated with the radar range equation. Reduce the radar cross section of the target and the seeker receives less return power. Defeating stealth requires changing another parameter of the radar equation to counter the lower radar cross section. The simplest approach is more transmitted power using high power transmitters. The radar receivers can be made more sensitive or the antennas can be designed for higher gain. The changes that will occur in the future will probably be a mix of these approaches. Strike warfare may be pushed to higher altitudes and may have to attack more concealed targets creating new seeker antistealth requirements.

### **Future Strike Warfare Seekers**

The new seekers that will be deployed for strike warfare will be synthetic aperture radar seekers since they are a good match to ATR and are a good fit to INS/GPS midcourse guidance. Initially these seekers will be deployed for fixed targets. As new systems capable of attacking relocatable targets go into production, an infrared sensor will be added to the SAR to track the target all the way to impact. The SAR seeker can track the target through the cloud cover and hand off to the infrared seeker in the terminal flight phase. The infrared seeker will be an uncooled seeker that can perform satisfactorily at short ranges.

In addition to SAR seekers, low cost infrared seekers using uncooled sensors or low cost cooled arrays will be developed for lower cost weapons such as JDAM, JSOW or a Paveway like weapons. These seekers will strive for lowest cost to achieve better than GPS accuracy for increased target kill capability.

Other enhancements to strike warfare seekers will be transmitting the seeker imagery back to an aircraft for target impact assessment and potentially the extraction of intelligence information. As technology develops, the goal for weapon CEP will move towards hit-to-kill type accuracy to reduce collateral damage and destroy hidden targets that might have only small pieces exposed to attack aircraft.

### **Summary and Conclusions**

In summary, the next millenium will be the age of the intelligent missile seekers that will achieve all weather performance and near total autonomy. The weapons will begin to match the capability of modern aircraft and the needs of the warfighter. The percentage of weapons on target will steadily grow and weapon accuracy will continually improve towards hit-to-kill. In order to protect their warfighting capability, nations will conceal and mask more of their weapon factories, aircraft shelters, and munitions storage bunkers, creating a stealthy type of environment. This need will be fed by an increase in sophisticated reconnaissance assets making it difficult to hide from strike aircraft. Soon strike warfare will have to respond to a growing ground target stealth problem with more sophisticated sensors and new weapon delivery tactics.

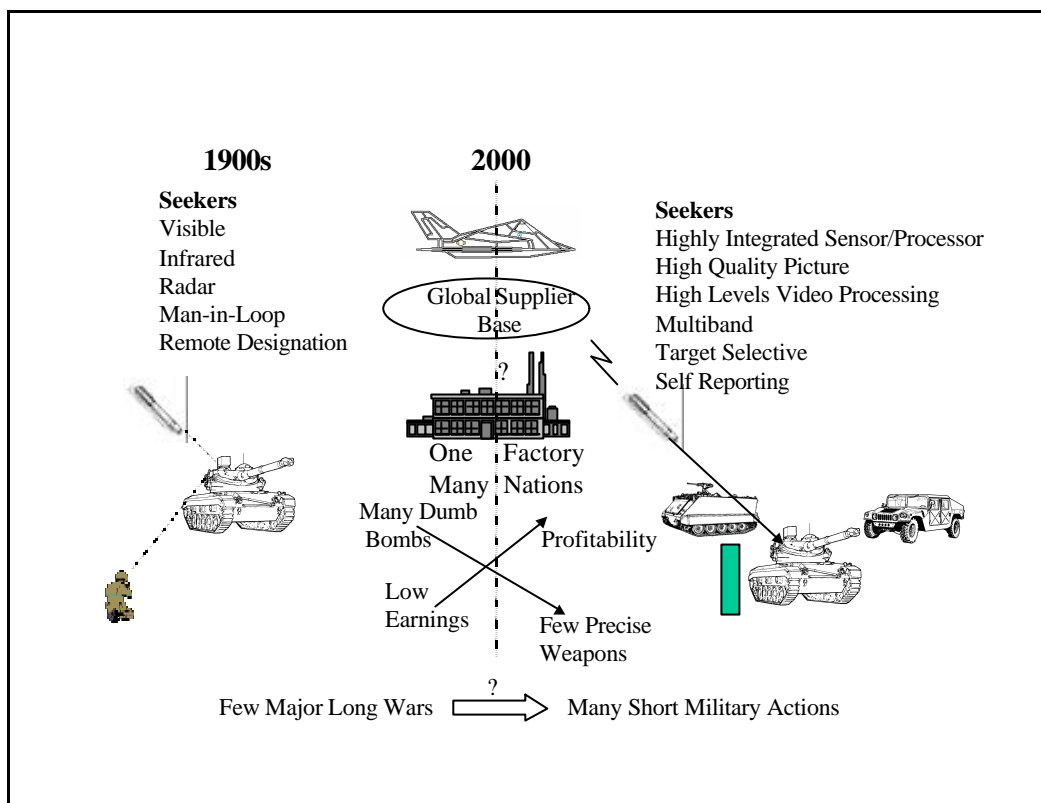

Figure 1. Flying Into The New Millenium

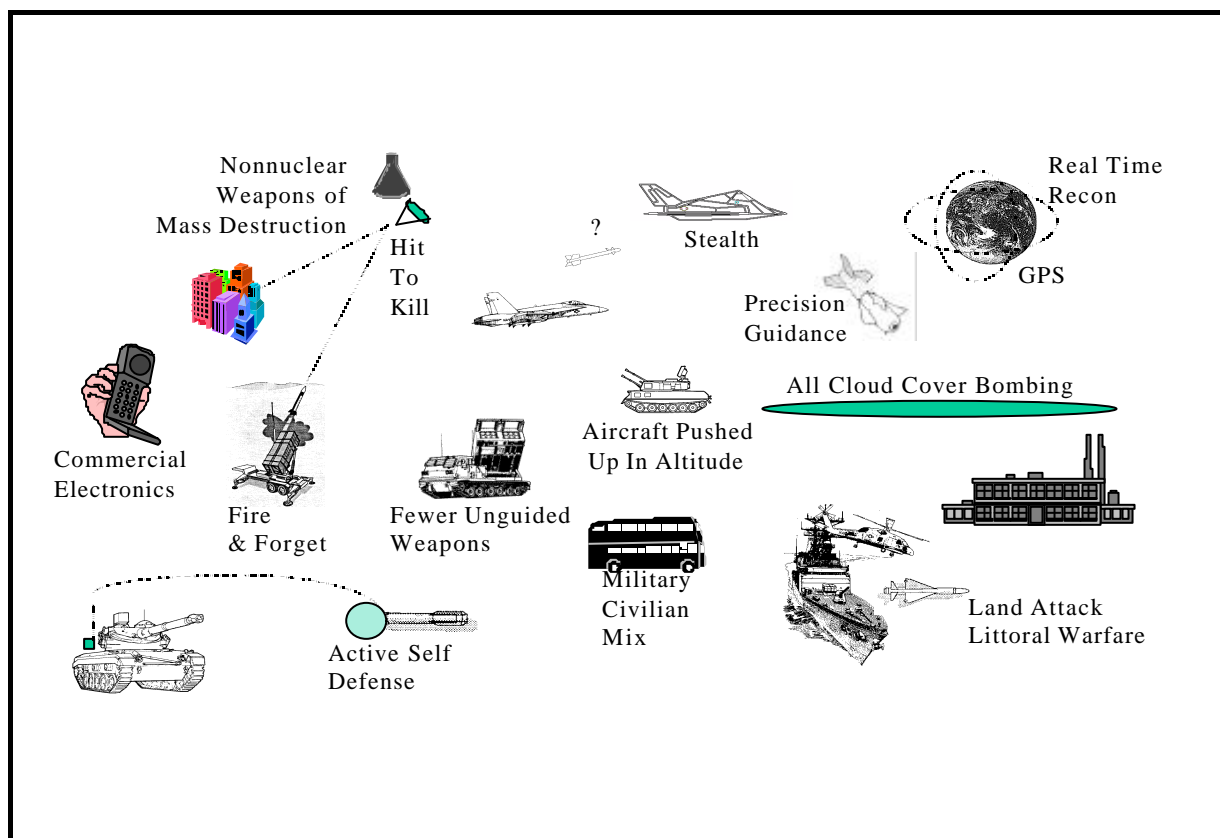

Figure 2. Changing Seeker Requirements



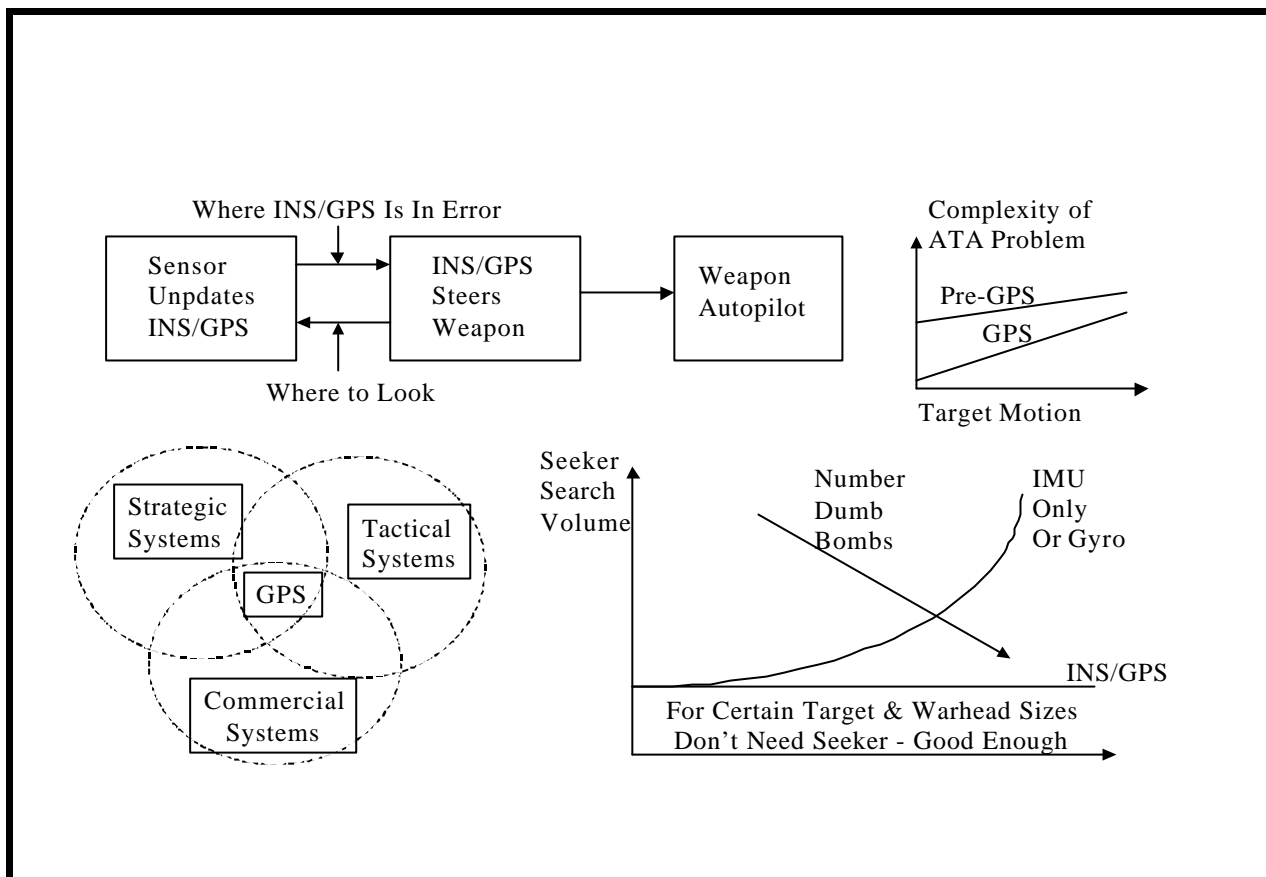

Figure 3. GPS Impact on Seeker Operation

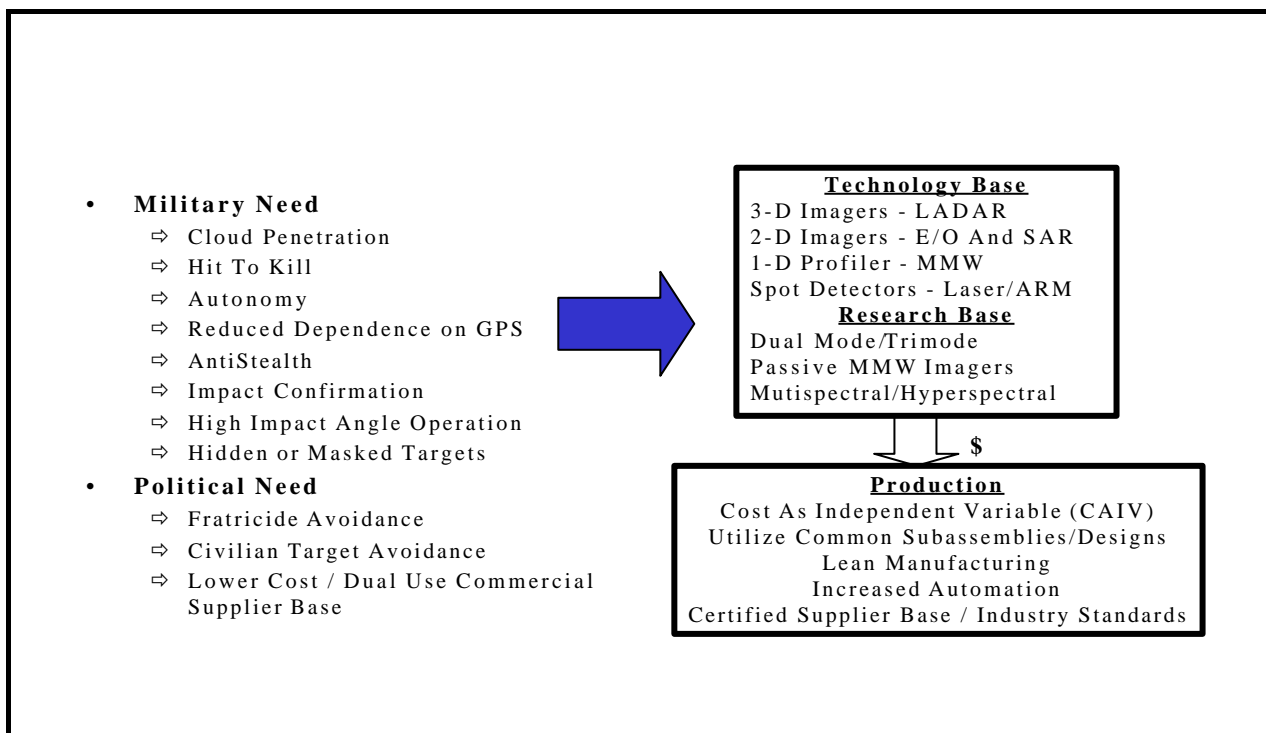

Figure 4. Future Investments

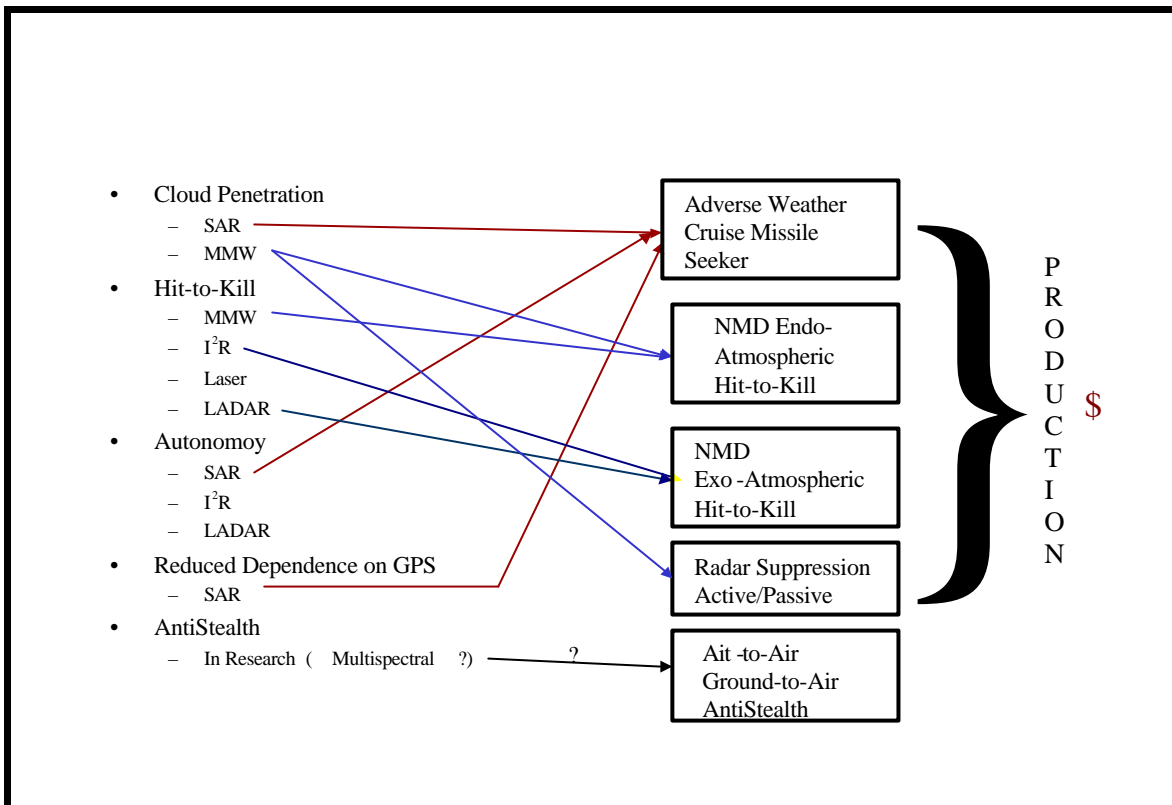

Figure 5. Seeker Versus Mission Area

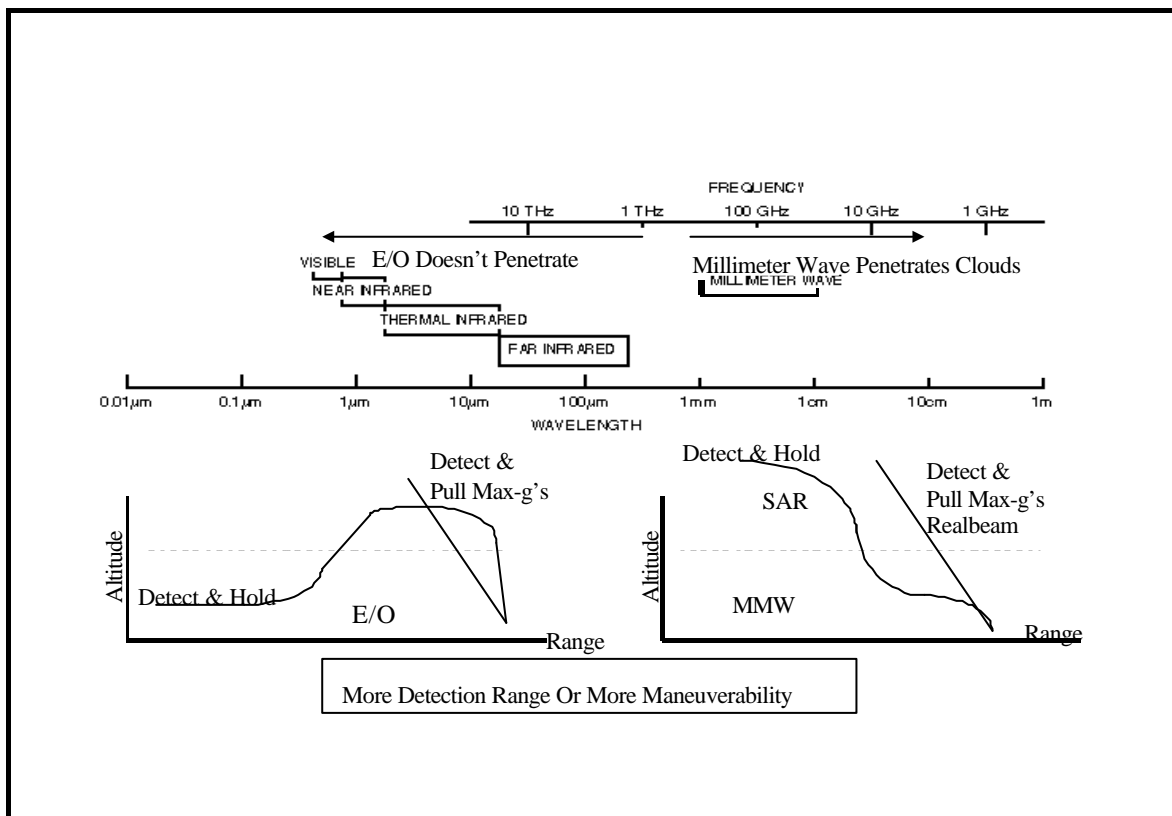

Figure 6. Cloud Penetration Problem

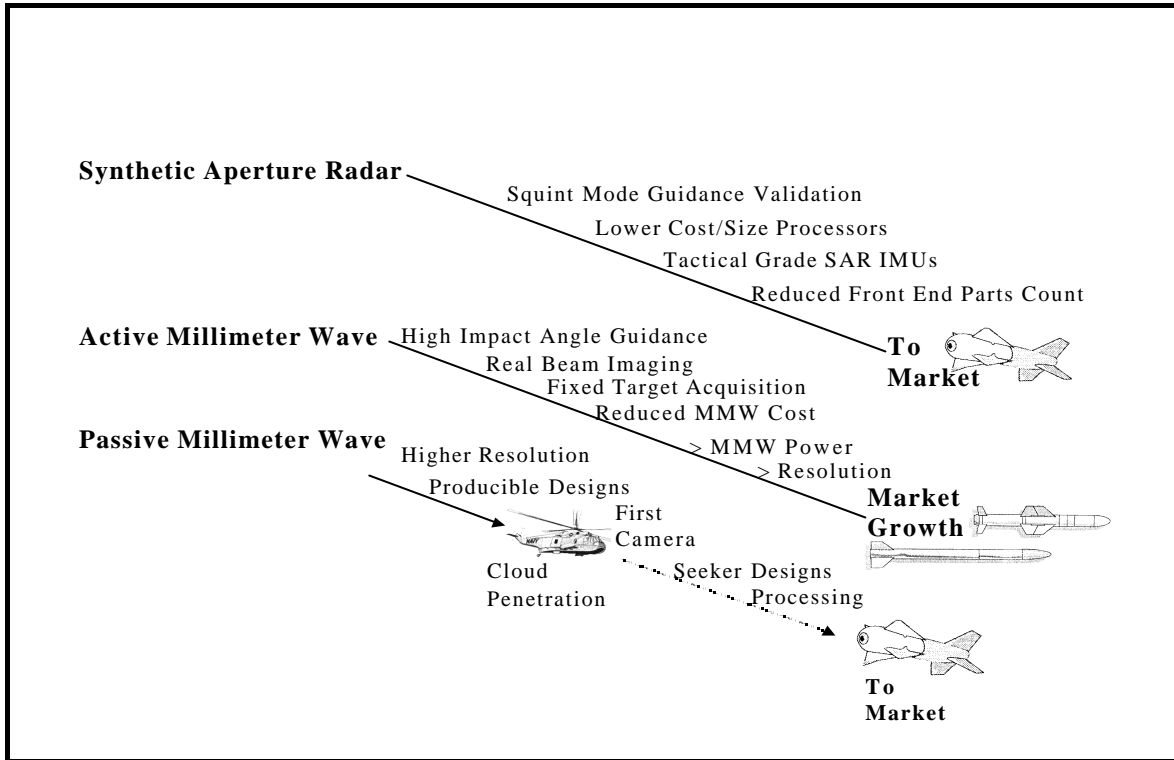

Figure 7. Radar Seeker Developments

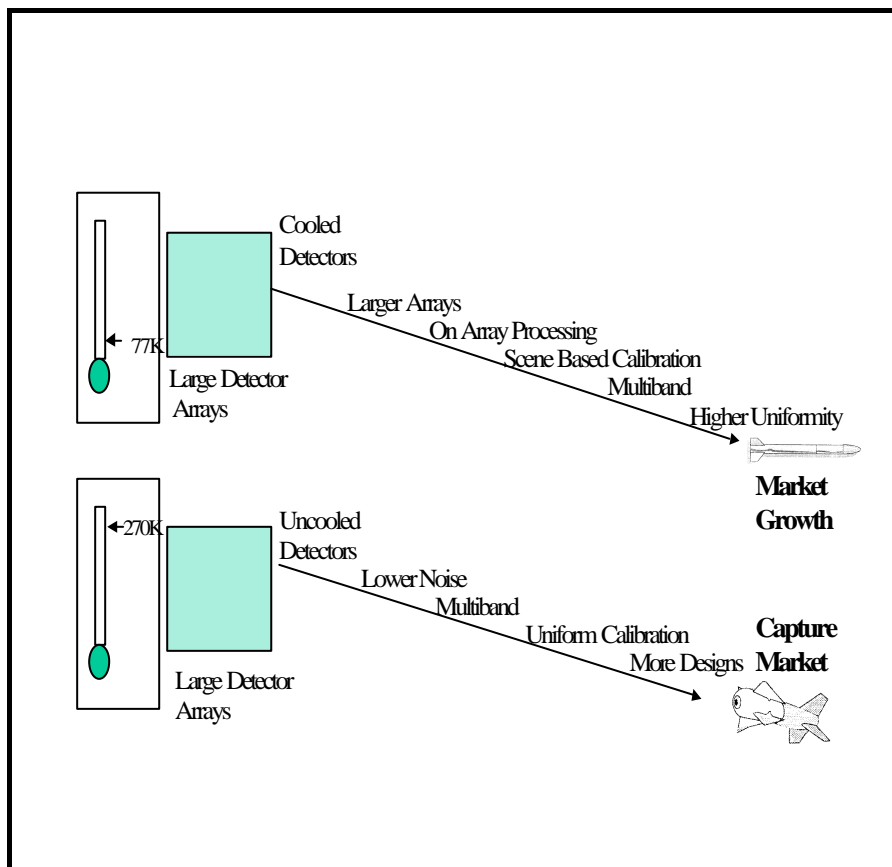

Figure 8. Trends in Infrared Seekers

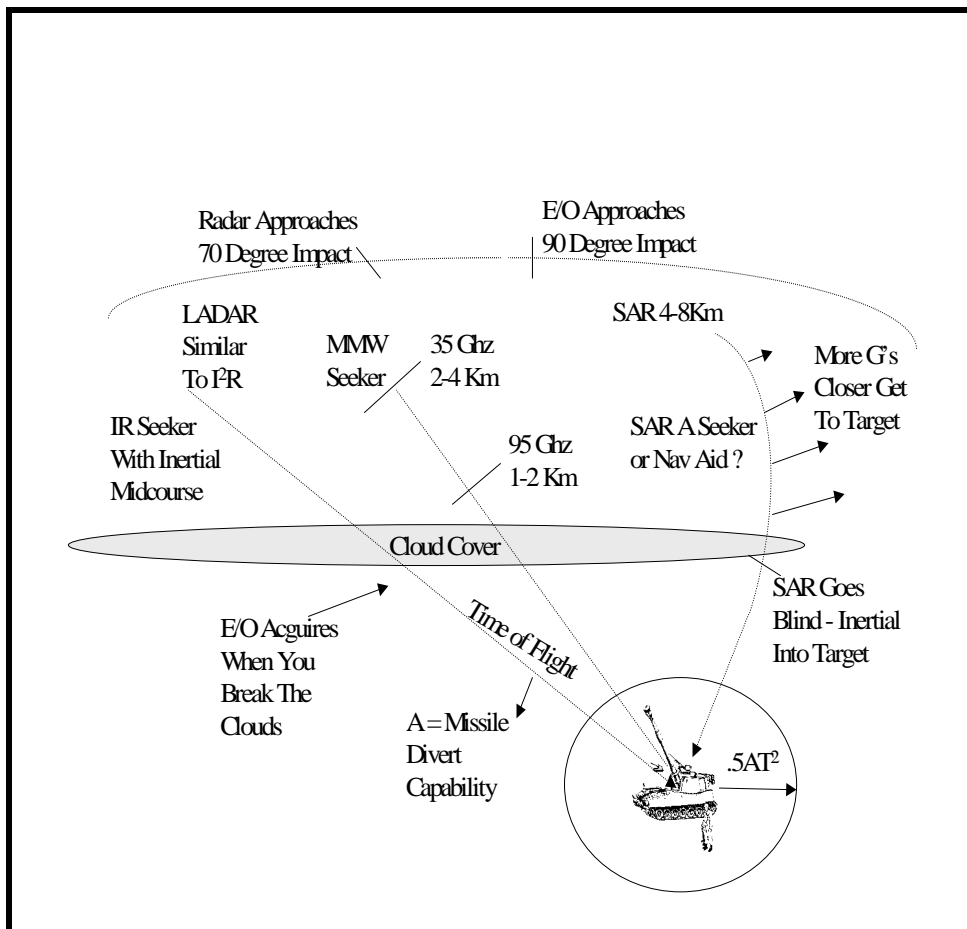

Figure 9. Airframe Seeker Trades

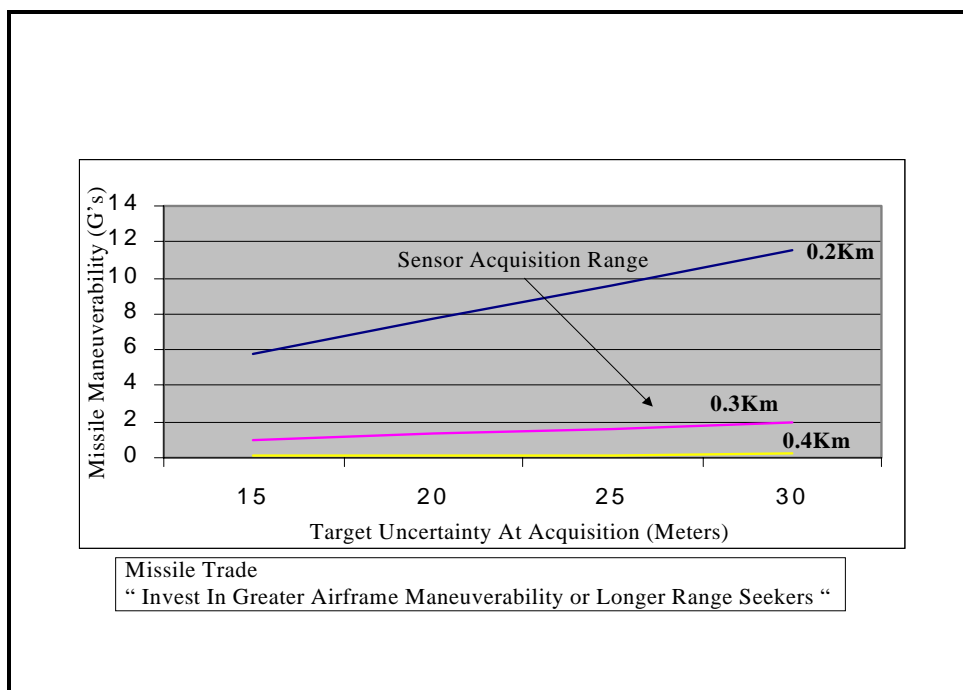

Figure 10. Required Missile Maneuverability

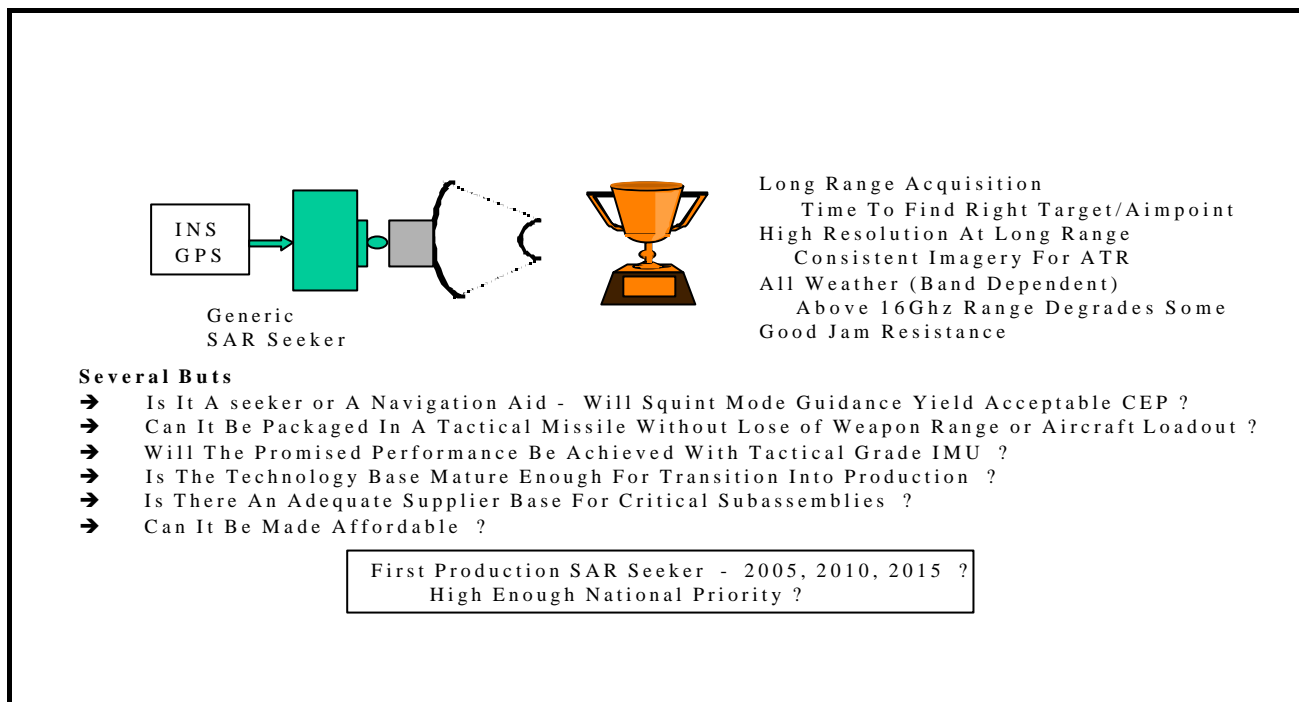

Figure 11. SAR Is Leading Adverse Weather Contender

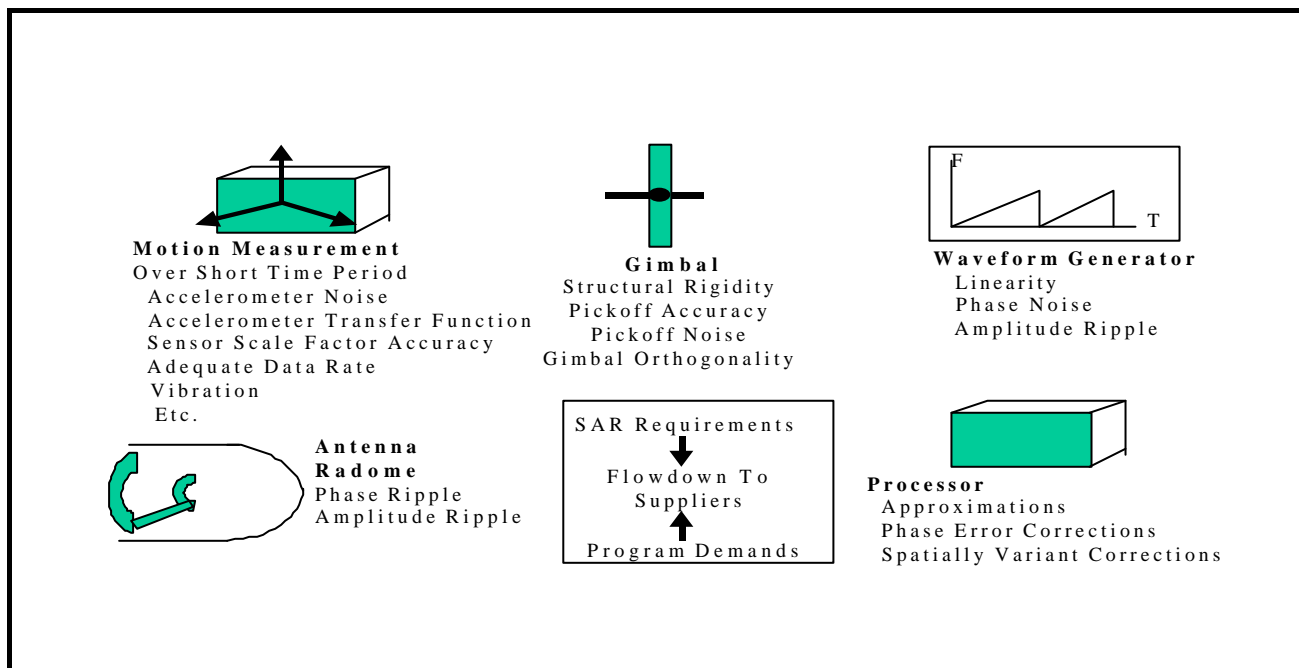

Figure 12. SAR Subsystems

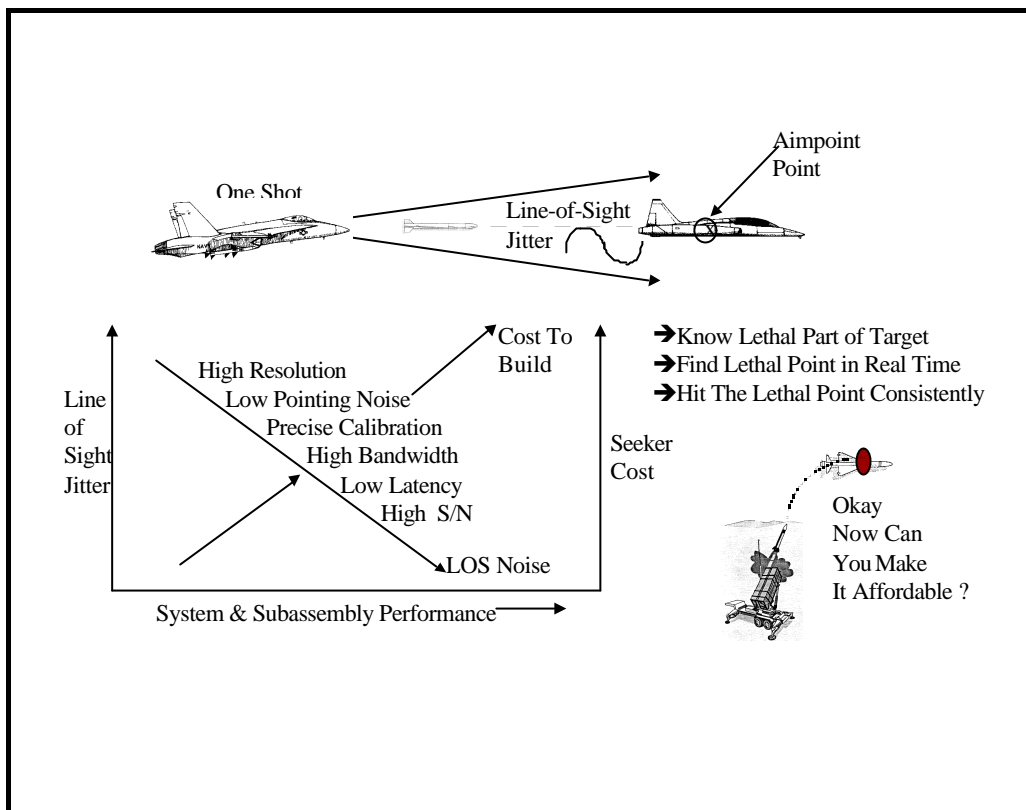

Figure 13. Hit To Kill Technology

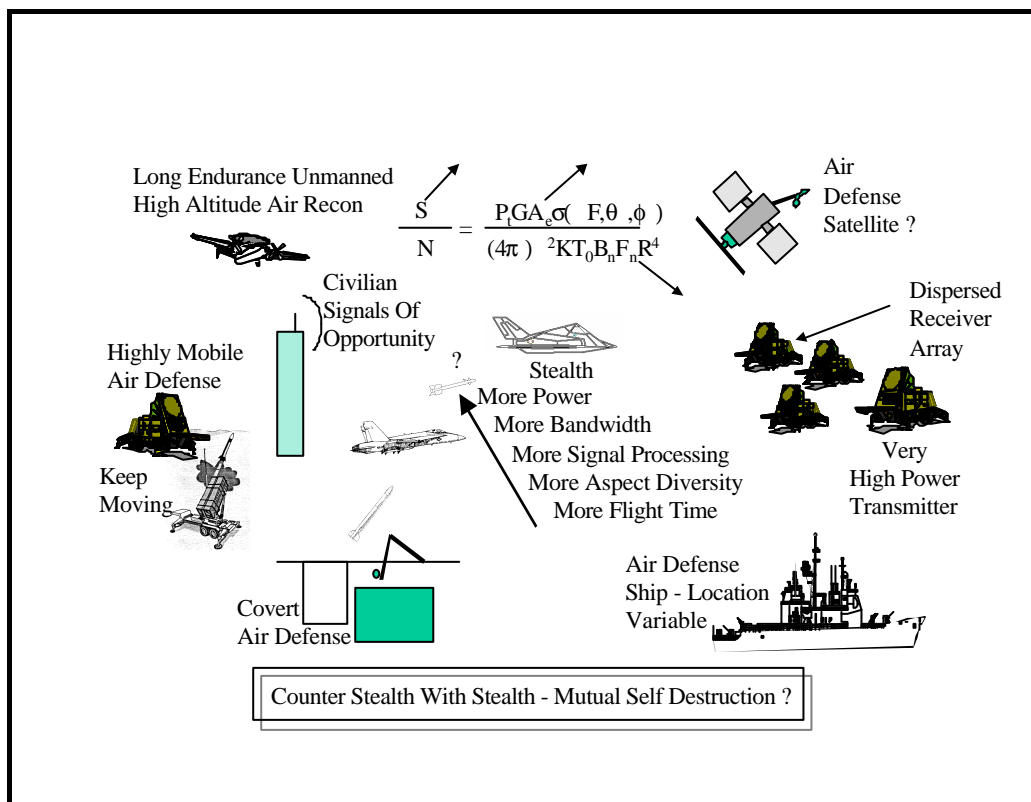

Figure 14. Defeating Stealth

# Technologies for Future Precision Strike Missile Systems - Missile/Aircraft Integration

**Eugene L. Fleeman**

Aerospace Systems Design Laboratory  
School of Aerospace Engineering  
Georgia Institute of Technology  
Atlanta, Georgia 30332-0150, United States  
[Eugene.Fleeman@asdl.gatech.edu](mailto:Eugene.Fleeman@asdl.gatech.edu)

## Abstract/Executive Summary

This paper provides an assessment of the state-of-the-art and design considerations of missile/aircraft integration for future precision strike missile systems. Benefits of missile/aircraft integration include compatibility with a broader range of aircraft carriage platforms, unrestricted carriage envelope, safe and accurate store separation, and enhanced survivability for the aircraft platform. Technologies and design considerations are grouped into the following discussion areas:

- **Missile factor of safety compatibility.** Assessments in this area include structural design factor of safety, carriage flight loads, and design specification of the carriage flight environment.
- **Missile carriage and launch compatibility.** Assessments in this area include launch platform compatibility constraints, firepower, light weight logistics, launcher alternatives, compressed carriage, standard suspension requirements, and safe separation.
- **Survivability (missile observables/insensitive munitions) compatibility.** Assessments in this area include internal carriage, reduced observable plumes, and insensitive munitions.

## Introduction

Missile/aircraft integration sets constraints on the missile that must be considered early in the design development process, as illustrated in Figure 1. Moreover, the design process requires iteration to harmonize the outputs from the diverse areas of mission/scenario definition, missile requirements, aircraft integration, missile concepts, and technologies. In a few cases it may be possible to modify a launch platform to accommodate a new missile, but in most cases this is not an option. Generally the launch platform is a constraint that drives the missile design. For example, AMRAAM was originally developed as a light weight radar missile for carriage on the wing tips of the F-16, which has a 300 pound weight limit. Later, AMRAAM was modified to a compressed carriage configuration (clipped wings and tails) to better accommodate internal carriage in the F-22 center weapons bay. Precision strike missiles are driven as much by launch platform compatibility as other measures of merit. Weapon compatibility with all launch platforms has high payoff in the neckdown benefit cost savings of fewer missile logistics systems.

Figure 2 shows an example of how missile/aircraft integration impacts the design validation/technology development process. Launch platform integration is considered from the start of subsystem development activities, continuing as they evolve into a missile system. In the propulsion area, static firings and insensitive munition tests are conducted before a missile with a live rocket motor is fired from a launch aircraft. In the airframe area, wind tunnel testing includes not only the basic aerodynamic configuration development, but also store separation wind tunnel tests. In the guidance & control area, the flight control system sensors, actuators, and electronics are analyzed to ensure safe separation as part of a missile modeling and simulation activity. The laboratory tests include environmental tests that simulate the operational temperature and vibration. The missile modeling and simulation activities include safe separation analysis. Similar to the propulsion area, the warhead has insensitive munition tests prior to firing a missile with a live warhead from an aircraft.

The flight test progression is shown on the far right of Figure 2. Flight test validation is a progressive activity of increasing complexity. The objective of progressive testing is to minimize risk and enhance safety in the flight test activity. A typical progression of flight testing begins with captive carry and ends with live warhead launches. Intermediate tests are store jettison tests, safe separation tests, unpowered guided flights with an inert warhead, powered guided flights with an inert warhead, and finally, all-up powered guided flights with a live warhead.

A summary of the subsystem technologies for precision strike missiles that relate to missile/aircraft integration is given in Figure 3. In addition to subsystem technologies, considerations such as structure design, carriage environment, geometry/weight constraints of the aircraft, aircraft launcher requirements, and aircraft survivability also drive missile/aircraft integration. Many of the technologies in the figure are covered in this paper, however there is not sufficient time to address them all. A summary of other technologies is presented in the Introduction/Overview paper of this lecture series.

## Missile Factor of Safety Compatibility

This assessment of missile factor of safety compatibility addresses the design considerations of structural design factor of safety, process for defining the missile structure design for compatibility with carriage flight loads, and design specification of the carriage flight environment.

**Structural design factor of safety.** Missile structure/aircraft integration includes the factor of safety considerations for manned operation. Typical factors of safety for tactical missiles are shown in Figure 4. The factor of safety tends to be high where there is human danger involved. As an example, pressure bottle ultimate and yield factors as safety are typically 2.5 and 1.5 respectively. Missile gas bottles can be pressurized up to 10,000 psi. Because gas bottles require periodic logistics maintenance and inspection by ground personnel, the factor of safety is high. Another area where the factor safety is high is in the area of ground handling loads, such as cross-country transportation. Factors of safety for ground handling loads are 1.5 ultimate loads and 1.15 in yield loads. Other examples of high factor of safety are captive carriage and separation. During carriage or during aircraft separation, missile factors of safety are required to be about 1.5 for ultimate and 1.15 for yield. The motor case is designed not only for conditions of environmental extremes, such as a hot day, but also for consideration of pilot safety. The ultimate and yield factors of safety for motor maximum effective operating pressure are about 1.5 and 1.1 respectively. The required factors of safety are lower for flight conditions where the missile is safely away from the launch aircraft. For example, missile free flight loads factors of safety are about 1.25 and 1.1 respectively and the thermal loads, which occur near the end of flight, are just design considerations with a factor of safety of 1.0. A distinguishing characteristic of precision strike missiles is lower factor of safety compared to manned aircraft or even unmanned air vehicles (UAVs). Since missiles are a throw-away, the factor of safety can be reduced if there is no human danger involved, resulting in lighter weight compared to an aircraft or a UAV. It is noted that an additional factor of safety is required for structural areas where there is relatively large uncertainty. An example is castings, which can have hidden voids, requiring an incremental factor of safety of about 1.25 in addition to the normal design factors of safety. Fittings also require an additional factor of safety of about 1.15 because of the uncertainty in the analysis for attachment integrity. The applicable military standards in the U.S. that are considered in factors of safety include environmental (HDBK-310, NATO STANAG 4370, MIL-STD-810F, MIL-1670A), strength and rigidity (MIL-STD-8856), and captive carriage (MIL-STD-8591) military standards.

Because high performance missiles such as ramjets are severely weight and volume limited, there is high leverage in improving performance if the required factor of safety could be reduced. Technology in improved analysis and development tools will provide reductions in missile weight and cost by reducing the design uncertainty and the required factor of safety. An example is Micro-machined Electro-Mechanical Systems (MEMS) technology. MEMS devices are fabricated from a single piece of silicon by semiconductor manufacturing processes, resulting in a small, low-cost package (see Figure 5). For example, between 2,000 and 5,000 MEMS sensor devices are produced from a single five-inch silicon wafer. Future precision strike missiles will have low cost/small size MEMS sensors for data collection during missile development and for health monitoring after production. Localized stress/strain, vibration, acoustics, temperature, pressure, and



other environmental conditions can be monitored through sensors scattered around the airframe. The higher confidence due to MEMS data will allow weight reduction in the over designed structure.

**Carriage flight loads.** Flight carriage impact on missile design is illustrated in Figure 6. A comparison is shown of a representative distribution of missile free flight maneuver loads versus launch platform carriage loads. The left section of the figure shows a typical free flight maneuvering air load distribution and the weight load distribution on each bulkhead. The right section of the figure shows a typical maneuvering aircraft carriage air load distribution, carriage weight load distribution, and carriage suspension loads. The missile free flight loads are usually higher than the carriage loads because missile maximum maneuverability is usually greater than that of aircraft. The missile skin thickness is usually not sized by aircraft maneuver loads. As shown in the right section of the figure, carriage loads are taken out through a suspension system. It is usually possible to get a fairly accurate prediction of the missile free flight loads. Also, wind tunnel tests are usually conducted to determine free flight air loads. Unfortunately, this is usually not the case for carriage flight loads, as it is difficult to accurately predict the two-body problem of a store in the flow field of the launch aircraft. In addition, it is difficult to get accurate wind tunnel data, due to the small size of the missile model for aircraft carriage wind tunnel tests. As a result, the current approach to estimating carriage loads is usually based on the conservative process of Military Standard (MIL STD) MIL-A-8591. As missile loads estimation becomes more accurate in the future, there is a potential for structure weight savings, based on improving the estimation accuracy for carriage loads.

**Design specification of the carriage flight environment.** Air launched precision strike missiles must have sufficient robustness in their design to accommodate a broad flight environment during carriage. Table 1 has examples of environmental requirements for storage and aircraft carriage temperature, humidity, rain, wind, salt fog, vibration, shock, and acoustics. An example of concern at the temperature extremes is propulsion and warhead safety, reliability, and performance. Another example is high rain rate. Rain is a particular concern for dome erosion at high carriage velocity. A third example is corrosion from salt fog, particularly for naval operation. An advantage of internal bay carriage over external carriage is that many of the carriage environment concerns are alleviated. However, some carriage environment concerns could be greater for internal carriage than that of external carriage. Examples include high vibration and acoustic loads when the carriage bay doors are open at a flight condition with high dynamic pressure.

## Missile Carriage and Launch Compatibility

This assessment of missile carriage and launch compatibility addresses the design considerations of launch platform compatibility constraints, firepower, light weight logistics, launcher alternatives, compressed carriage, standard suspension requirements, and safe separation. New technology development for weapon compatibility and high firepower includes low volume missile propulsion, ordnance and airframe; store carriage and store separation wind tunnel tests; computational fluid dynamics (CFD) predictions; and finite element modeling (FEM) predictions.

**Launch platform compatibility constraints.** Carriage constraints for missiles on surface ships, submarines, and aircraft are shown in Figure 7. Cross-platform compatibility is desirable for a missile system. A larger total buy of missiles for cross-platform application has benefits of lower unit production cost and lower logistics cost. In the United States, the Vertical Launch System (VLS) is a standard carriage and launch system for missiles on surface ships. The VLS geometry constraints are 22 inches x 22 inches x 256 inches. The maximum weight constraint is 3,400 pounds. United States submarines have a similar standard launcher that is circular in cross section. The submarine Canister Launch System (CLS) has a diameter constraint of 22 inches and a length constraint of 256 inches. Maximum missile weight for the CLS is the same as that of the VLS, 3,400 pounds. The VLS and CLS also have a maximum limit on the total impulse delivered in the event of hangfire, to avoid burning through the launch platform structure. Finally, aircraft launch platforms for missiles include tactical fighters, bombers, helicopters, and UCAVs. Shown in the figure is an example of a fighter aircraft, the F-18C. The F-18C carries weapons externally on pylons and rails. Other aircraft, such as the F-22, RAH-66 and B-1, have an additional capability of internal carriage. Internal launchers include vertical ejection, rail trapeze, and rotary ejection. Missile span constraint for aircraft carriage is about 24 inches x 24 inches. Length constraint is about 168 inches and the maximum allowable missile weight varies

from about 500 to 3,000 pounds, depending upon the aircraft. There is a desire for lighter weight missiles to maximize the firepower of small aircraft such as the F-18C, Comanche, and Predator. As an example, 50 percent of the U.S. Navy fleet combat aircraft in the year 2010 time frame are expected to be F-18Cs.

**Firepower.** Figure 8 shows how day/night operation, firepower objectives, and weapons loadout affect the maximum allowable weight of a precision strike missile. Shown are examples of the F-18C and F-18E aircraft. Note that the F-18C aircraft has less capability than the F-18E in all loadout configurations. Figure 8 shows a large difference in maximum allowable missile weight for day versus night operation. The difference is due to the additional fuel that must be reserved for night operation off an aircraft carrier. The maximum weapon weight shown in the curves must also be reduced to account for limits in asymmetric carriage (2,500 lb for inboard carriage and 1,500 lb for outboard carriage). Finally, note the reduction in maximum allowable missile weight as the loadout configuration is changed from a clean aircraft with precision strike missile(s) to other configurations. Five other loadout configurations are the precision strike missile(s) plus 1) a centerline fuel tank, 2) two inboard fuel tanks, 3) centerline fuel tank plus two Sidewinder air-to-air missiles, 4) centerline fuel tank plus two anti-radiation missiles (ARM), and 5) two inboard fuel tanks plus two Sidewinders. The maximum allowable weight of a single precision strike missile on the F-18E is about 4,800 lb under ideal conditions. For an F-18C operating at night with two inboard fuel tanks and two Sidewinders, the maximum allowable weight of a precision strike missile is much lower, about 1,800 lb. In the case of carriage of two precision strike missiles, the F-18E under ideal conditions can carry a missile weighing up to 2,400 lb. At the other extreme for an F-18C loadout of two precision strike missiles, operating at night with the addition of two inboard fuel tanks and two Sidewinders requires that the precision strike missile weigh less than 900 lb. A precision strike missile weight of about 1,400 lb is probably a good compromise for the example of F-18C/E aircraft integration. It allows two weapons on the F-18C for unrestricted day operation, two weapons on the F-18E for near unrestricted night operation, and three weapons on the F-18E for day operation with two inboard fuel tanks.

**Light Weight Missile Logistics.** Shown in Figure 9 are examples of the impact of missile weight on the support manpower requirements for tactical missiles. A typical maximum lift requirement per person is between 50 to 100 pounds. For a man portable missile such as the 50-pound Javelin system, a single gunner can prepare and launch the missile. As an example of a moderately heavy missile, the 190-pound Sidewinder requires two-to-four personnel to install the missile on the launch aircraft. A heavier missile, such as a 500-pound Sparrow, requires additional support personnel plus ground support equipment. Finally, a very heavy weapon, such as a laser guided bomb, requires specialized, heavy ground support equipment.

**Compressed carriage.** A missile that has reduced span surfaces during carriage allows closer spacing of the adjacent missiles on the launch platform. Approaches for compressed carriage include reduced span/longer chord surfaces, folded surfaces, wraparound surfaces, and switch blade surfaces. Figure 10 illustrates the benefits of compressed carriage. The F-22 internal center weapons bay typically has two partitions, with one partition for air-to-air (e.g., AMRAAM) missiles. A baseline AMRAAM loadout in an F-22 center bay partition allows two missiles per partition. However, compressed carriage AMRAAM can be packaged three missiles per partition, a 50 percent increase in the firepower load-out. For an air-to-air mission only, both partitions of the F-22 center bay are allocated to air-to-air missiles, allowing a bay loadout of six compressed carriage AMRAAMs.

**Launcher integration.** Figure 11 shows examples of missile carriage on U.S. standard rail and ejection launchers. In the upper left is an AGM-114 Hellfire II missile on a helicopter rail launcher. Rail launchers are particularly suited to light weight, high thrust missiles such as Hellfire. Hellfire weighs 100 lb, with a launch thrust-to-weight of about 30:1. Hellfire has a laser seeker with +/- 30 degrees field of regard. A launch platform integration consideration is that the missile must be mounted sufficiently far forward on the aircraft such that the seeker line-of-sight to the target is not obscured by the launch platform. Another concern for rail launch is the effect of tip off error on the missile miss distance at the minimum effective range. A rail-launched missile has roll, pitch and yaw rate excursions as it moves down the rail, due to missile/rail clearances and the aeroelasticity of the launcher. Tip off error at launch has an effect on the missile miss distance at its minimum effective range. Another contributor to missile miss distance at the minimum effective range is the effect of helicopter downwash on the missile angle of attack at launch. In the upper right

corner of Figure 11 is an AGM-88 HARM missile. Most precision strike missiles, including HARM, use ejection launch. HARM has an anti-radiation homing seeker. The installation pylon must also be sufficiently far forward on the aircraft that the seeker line-of-sight to the target is not obscured by the launch platform. The pylon contains ejection cartridges that provide downward velocity and pitch rate to the missile at launch, aiding safe and accurate separation. Suspension of the missile is such that the missile center-of-gravity is midway between the ejectors. A concern during launch is the aircraft local angle of attack and local angle of sideslip effects on the missile flight trajectory. Finally, the bottom of Figure 11 shows an example of internal carriage. Eight AGM-69 SRAM missiles are shown on a bomber rotary launcher. The missiles are ejected from the bay at an ejection velocity of about 20 ft/sec. Concerns for internal bay carriage include bay acoustics, bay vibration, and flow field angularities near the aircraft.

**Standard suspension requirements.** Store suspension requirements for ejection launchers, based on US MIL-STD-8591 are summarized in Table 2. Shown are store weight and parameters for light weight stores (up to 100 lb), medium weight stores (101 to 1,450 lb), and heavy weight stores (over 1,451 lb). Suspension alternatives are 30-inch and 14-inch suspension systems. For an ejected store weight up to 100 lb, only the 14-inch suspension can be used. For a light weight missile on the 14-inch suspension, the lug height and minimum ejector pad area are prescribed as 0.75 inch and 4.0 in x 26.0 in respectively. For a medium weight missile, with a weight between 101 and 1,450 lb, either the 14-inch suspension or a 30-inch suspension may be used. Medium weight ejected stores have larger required lug height and minimum ejector area. They also require lug wells. The required lug wells could have a strong impact on the missile internal structure design. For example, in some cases the rocket motor overlaps the missile center of gravity, and it may be difficult to accommodate lug wells in the rocket motor case. A strong back may be required, similar to that of the AGM-69 SRAM missile. For a heavy missile with a weight over 1,451 lb, only the 30-inch suspension can be used. MIL-STD-8591 requires that the lugs have a deeper well if the missile weighs more than 1,451 lb.

Examples of missile rail launchers that are compatible with MIL-STD-8591 are shown in Figure 12. Rail launchers usually suspend the missile at two locations, a forward hanger and an aft hanger. Some rail launchers suspend the missile at three locations, for added stiffness. The launcher shown in the top of the figure is the LAU-7. The LAU-7 rail launcher has a store weight limit of 300 pounds and a store diameter limit of 7 inches. The LAU-7 is a standard launcher for the Sidewinder missile. It has forward and aft hangers with a shoe width of 2.26 inches. The LAU-117 rail launcher, shown in the bottom of the figure, has a store weight limit of 600 pounds and a store diameter limit of 10 inches. The LAU-117 is a standard launcher for the Maverick missile. It has a forward hanger with a shoe width of 1.14 inches and an aft hanger with a shoe width of 7.23 inches.

**Safe Separation.** Aircraft store compatibility wind tunnel tests are conducted to determine store carriage loads and store separation forces, moments, and trajectories. Figure 13 shows wind tunnel installations of aircraft and store models. Note that a typical aircraft store load-out has closely spaced stores. The local airflow around a store is difficult to predict. There is a complex flow field interaction of a store with the aircraft and also with the adjacent stores.

The types of wind tunnel testing for store compatibility include:

- Flow field mapping with a pitot static pressure probe to measure the local static pressure, total pressure, and angle of attack
- Flow field mapping with an instrumented store model on a sting to measure the forces and moments on the store immersed in the aircraft flow field
- Captive trajectory simulation of an instrumented store model on a sting
- Drop testing of store models. The store models are constructed of lead, tungsten, or even gold to provide weight scaling to simulate full-scale buoyancy in the wind tunnel test.

Examples are shown in Figure 14 of safe separation of a rail launched AMRAAM from an F-16 and the clean separation of two laser guided bombs dropped from an F-117. In the bottom right corner is a photograph showing the clean separation of a rapid bomb drop from the B-2 bomber. A rapid bomb drop is desirable to

minimize the exposure time with the high observables from the open weapon bay. Exposure time less than ten seconds is desirable to prevent threat radars from establishing a track file.

## Survivability (Missile Observables and Insensitive Munitions) Compatibility

This assessment of survivability (missile observables and insensitive munitions) compatibility addresses the design considerations of internal carriage, reduced observable plumes, and insensitive munitions.

**Internal carriage.** Alternative approaches for missile carriage include conventional external carriage, conformal carriage, and internal carriage. Conventional external carriage has disadvantages of high radar cross section (RCS), high carriage drag, and potentially adverse aeroelastic, stability, and control interactions with the aircraft platform. Conformal carriage has an advantage of reduced RCS and drag compared to conventional carriage. However, the preferred approach for the lowest carriage RCS and the lowest drag is internal carriage. Figure 15 shows examples of internal carriage and loadouts for low observable fighters, bombers, and helicopters. In the upper left is shown the F-22 internal center bay. The F-22 center bay typically has an outboard partition for air-to-air weapons (e.g., AMRAAMs) and an inboard partition for air-to-surface weapons (e.g., JDAM). LAU-142/A pneudraulic (pneumatic plus hydraulic) ejection launchers are provided for the AMRAAMs. The LAU-142 has a nine-inch stroke that ejects an AMRAAM from the bay at a velocity of 25 feet per second. The peak ejection acceleration is 40 g. Advantages of pneudraulic ejection compared to conventional pyrotechnic cartridge ejection include less logistics, faster turnaround for weapon loading, and a more nearly constant ejection force that allows a shorter ejection stroke. A conventional BRU-46/A bomb rack is provided for the GBU-32 JDAM (1,000-pound class weapon). Examples of typical mixed weapon loadouts in the F-22 center bay are (1) two AMRAAMs (without compressed carriage) plus one 1,000 pound JDAM, or (2) three compressed carriage AMRAAMs plus one 1,000 pound JDAM. The F-22 center bay can also be set up for air-to-air weapons only, such as four conventional AMRAAMs (without ompressed carriage) or six compressed carriage AMRAAMs. The F-117 internal weapons bay is shown in the top center of the figure. The F-117 weapons bay is similar to that of the F-22, except that it has about twice the payload weight capability. A typical loadout for the F-117 is two Paveway guided bombs (2,000 pound class). Shown in the figure foreground is the GBU-27 laser guided bomb. Its warhead is based on the BLU-109 hardened structures penetrator bomb. In the background is the GBU-10 laser guided bomb. Its warhead is either the general-purpose Mk-84 bomb or the BLU-109 penetrator bomb. The B-1 bomber weapons bay is shown in the upper right of the figure. The B-1 has three bays. Each bay has a rotary launcher for ejection of missiles and bombs. An Ejector Rack Assembly for each weapon is attached to the rotary launcher. The Ejector Rack Assembly has a thirty-inch spacing of the ejectors. Shown in the figure is a standard loadout of eight AGM-69s per bay. In the lower left section of the figure is a photograph of an F-22 side bay. The F-22 has two side carriage bays. Each bay is capable of carrying a single Sidewinder missile on a LAU-141/A trapeze rail launcher. A trapeze launcher is required for lock-on before launch missiles. During the launch sequence the trapeze launcher extends the missile away from the aircraft, the missile seeker acquires the target, and the missile is launched. It is noted that the LAU-141/A launcher has a deflector surface to keep the motor plume from entering the weapon bay. Finally, the lower right section of the figure is a photograph of the RAH-66 Comanche helicopter. The Comanche has two side bays with rail launchers. Each bay has a typical mixed mission (combined air-to-surface/air-to-air) loadout of one Hellfire missile plus two Stinger missiles plus four Hydra 70 rockets. For an air-to-surface only mission, each bay can carry three Hellfire missiles, giving the Comanche a total bay loadout of six Hellfire missiles. As shown in the figure, the Comanche can also carry eight Hellfire missiles externally, at the expense of increased RCS.

**Reduced observable plumes.** Table 3 shows tradeoffs of rocket motor performance versus safety and observable concerns. The highest performance propellants unfortunately also have high observable smoke particles (e.g.,  $Al_2O_3$ ), due to metal fuels such as aluminum. An initial approach to reduce plume observables is reduced smoke motors. Reduced smoke motors replace the metal fuel with a binder fuel such as hydroxyl terminated polybutadiene binder (HTPB). The performance and insensitive munition capability of a reduced smoke motor is slightly lower than that of a high smoke motor. Reduced smoke propellants can still have visual observables from a hydrogen chloride contrail. The HCl contrail occurs at low atmospheric temperature. A third type of propellant is minimum smoke propellant. Minimum smoke propellants eliminate the HCl contrail by eliminating ammonium perchlorate as an oxidizer, resulting in lower visual observables.

The performance and safety of current minimum smoke propellants is not as good as that of high smoke propellants. Current minimum smoke propellants are cross-linked double base (XLDB) propellants. In the older minimum smoke double-base propellants, the propellant consists generally of cotton (cellulose) combined with nitric acid to form nitrocellulose (guncotton), which in turn is combined with nitroglycerin, another fuel-oxidizer. In the double-base propellant, the nitrocellulose serves as the binder, and the nitroglycerin causes it to solidify. Examples of current minimum smoke propellants are HMX (cyclotetramethylene tetranitramine) and RDX (cyclotrimethylene trinitramine). An example of a new minimum smoke propellant is the US Navy China Lake CL-20 propellant. CL-20 is a cyclic polynitramine, with a unique caged structure that provides higher crystal density, heat of formation, and oxidizer-to-fuel ratio. CL-20 propellant has 10-to-20 percent higher performance than HMX and RDX. CL-20 also has reduced shock sensitivity (Class 1.3 versus 1.1) and milder cookoff reaction than either HMX or RDX. A disadvantage of CL-20 propellant is high cost (currently more than \$400 per pound). Another example of a new minimum smoke propellant developed by Russia is Ammonium Dinitramine (ADN). ADN performance and cost are similar to that of CL-20.

Figure 16 illustrates the plume observables of high smoke, reduced smoke, and minimum smoke propellants. The relatively old Sparrow missile rocket motor is a representative high smoke motor. The high smoke plume is shown in the upper left corner of the figure. Sparrow has high smoke  $\text{Al}_2\text{O}_3$  particles from aluminum fuel. Shown in the upper center of the figure is an example of a reduced smoke rocket motor. AMRAAM is a more recent missile, with a reduced smoke motor. It still has a contrail of HCl from the ammonium perchlorate oxidizer. The HCl contrail occurs if the atmospheric temperature is less than  $-10^\circ$  Fahrenheit, corresponding to altitudes greater than about 20,000 feet. Finally, the far upper right photograph is an example of a minimum smoke rocket motor. Javelin is a recent missile with a minimum smoke motor. It has almost no smoke from either the launch motor or the flight motor, enhancing the survivability of the gunner. Minimum smoke propellants can have an  $\text{H}_2\text{O}$  (ice) contrail if the atmospheric temperature is less than  $-35^\circ$  Fahrenheit, corresponding to altitudes greater than about 27,000 feet.

The bottom left section of the figure shows typical contrails for high smoke, reduced smoke, and minimum smoke motors. The high smoke motor solid particles are visible immediately behind the nozzle under all atmospheric conditions. The contrail from a reduced smoke motor occurs farther downstream of the nozzle. It is produced when the HCl gas from the reduced smoke motor is absorbed by water and then freezes at low atmospheric temperature. Finally, water vapor from a minimum smoke motor can also freeze farther downstream of the nozzle to produce a contrail at low atmospheric temperature.

**Insensitive Munitions.** Insensitive munitions have high payoff in improving launch platform survivability. The critical subsystems are the rocket motor propellant/engine fuel and the warhead. In the U.S. the design considerations for insensitive munitions are based on MIL-STD-2105B. MIL-STD-2105B includes design considerations of hardening against threat weapons, safety from fire, dropping the weapon, extremes in environmental temperature, missile vibration, and operation off an aircraft carrier. Hardening against threat weapons includes considerations of fragment impact and blast. Cookoff from a fire includes the type of fire (slow cookoff, fast cookoff) and the warhead or rocket motor reaction to the fire (e.g., burning, detonation). Drop shock sensitivity consideration is a particular concern for ground maintenance personnel dropping the missile during handling. The environmental temperature consideration includes both very low temperatures that could damage the rocket motor and very high temperatures that could cause detonation of the warhead or rocket motor. Missile vibration consideration includes the dynamic acceleration imparted by carriage on the launch platform. Finally, aircraft carrier operation includes the shock of aircraft landing sink rates as high as 18 ft/sec.

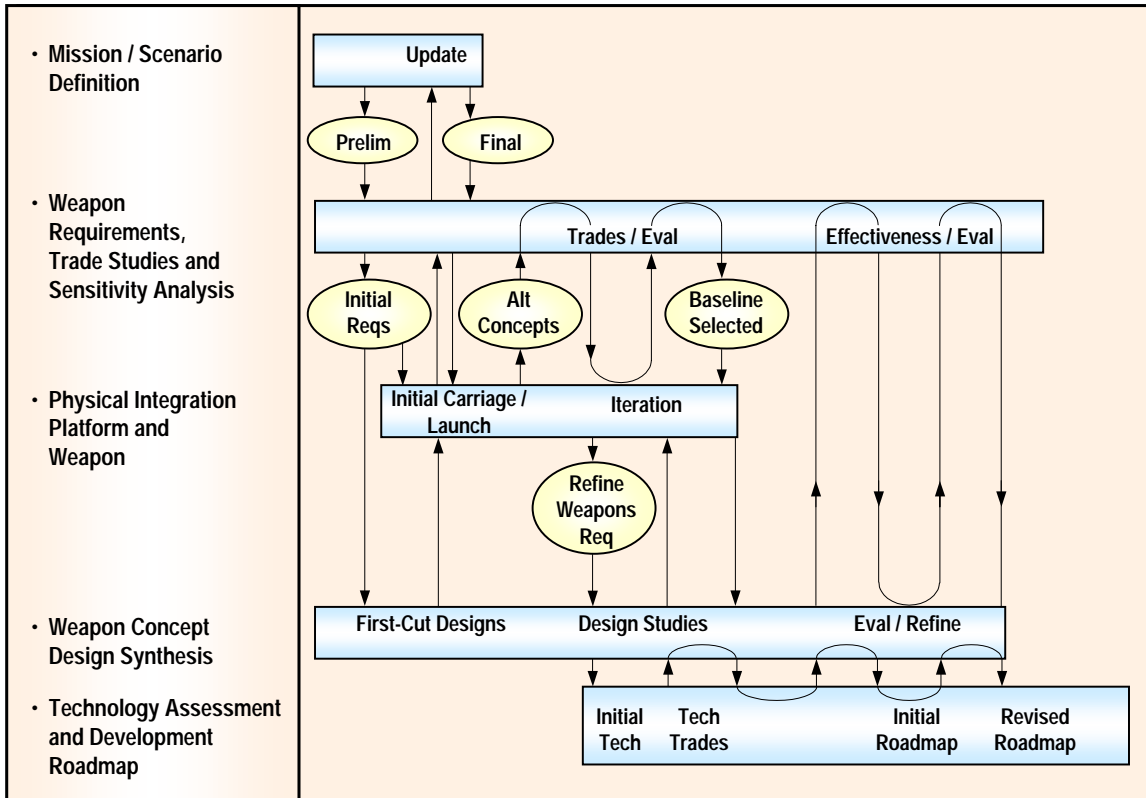

Figure 1. Launch Platform Integration Provides Constraints in Missile Design.

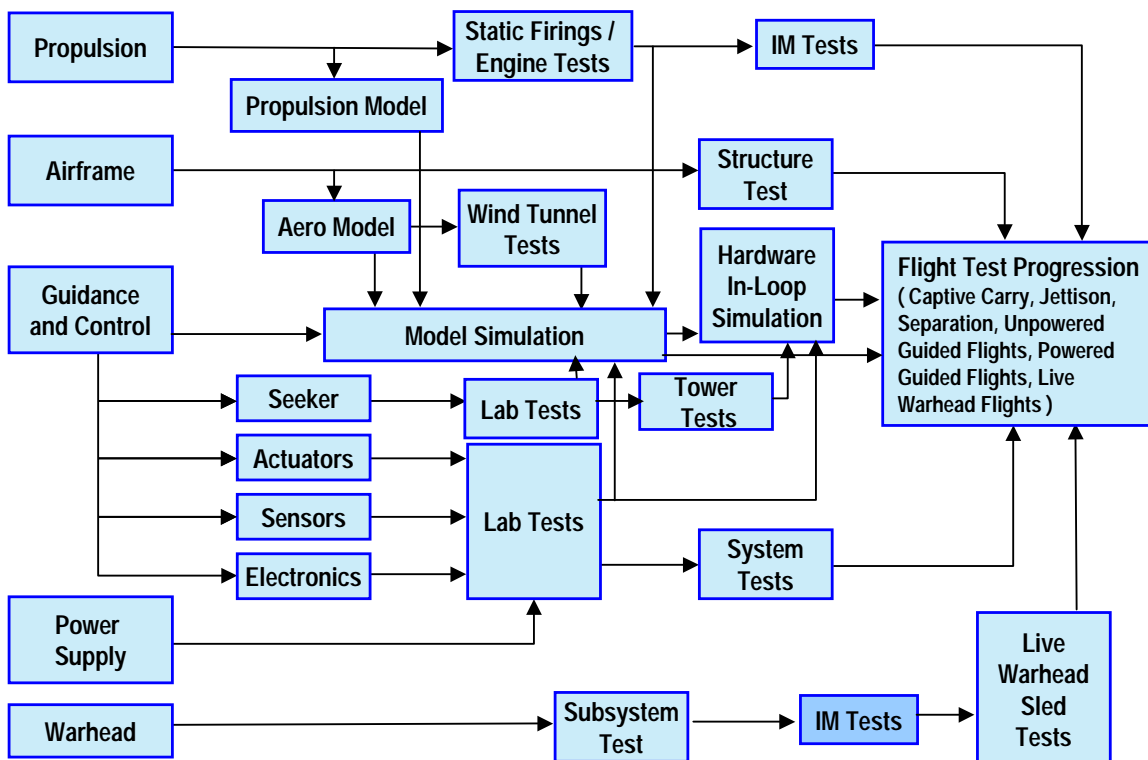

Figure 2. Air Launched Precision Strike Missile Development Leads to Aircraft Flight Test Validation

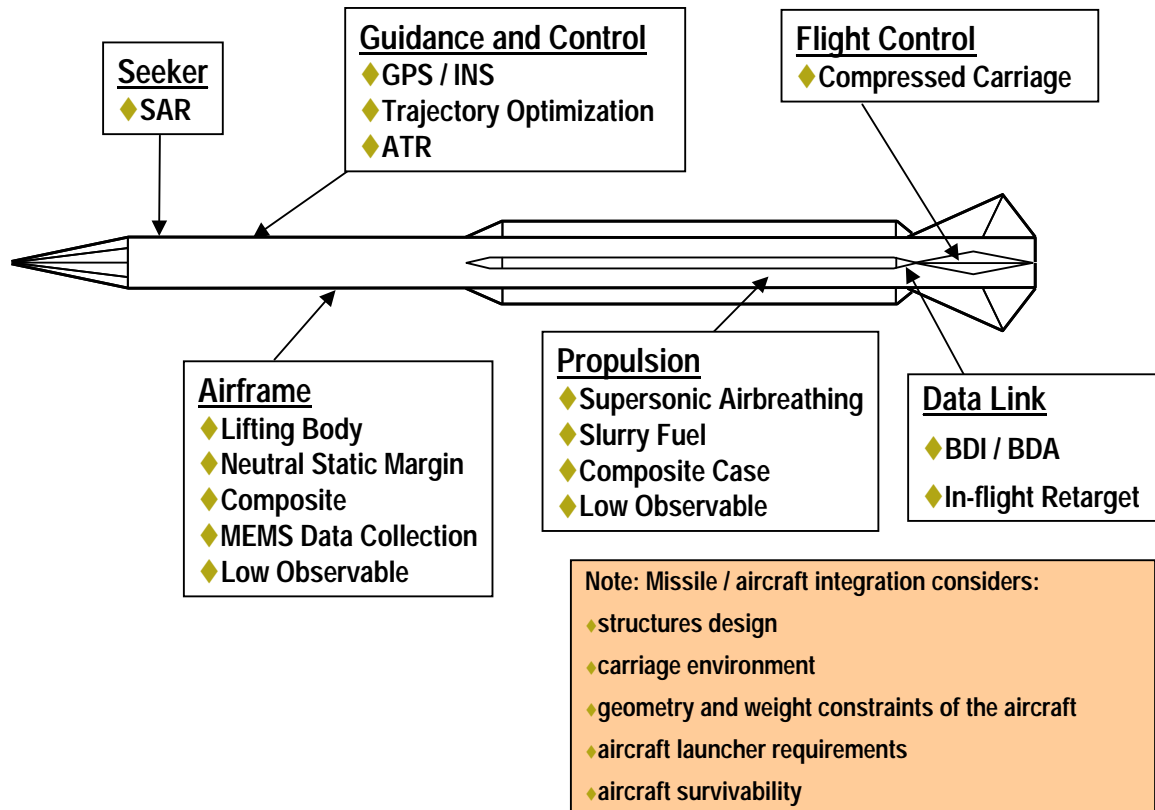
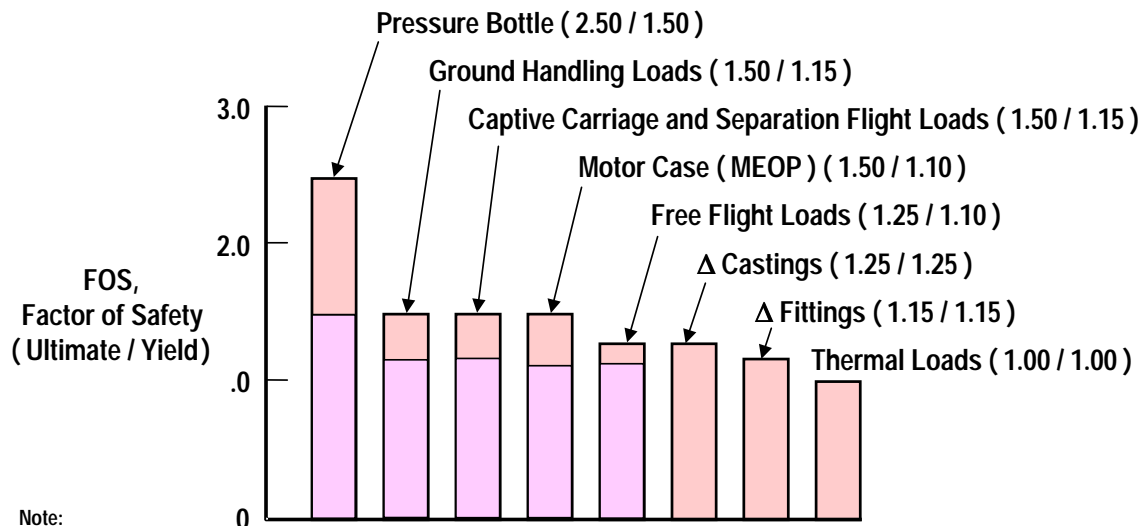

Figure 3. New Precision Strike Missile Technologies That Impact Aircraft Integration.



Note:  
 • MIL STDs include environmental (HDBK-310, NATO STANAG 4370, 810F, 1670A), strength and rigidity (8856), and captive carriage (8591).  
 • The entire environment (e.g., storage, ground handling, captive carriage, launch separation, post-launch maneuvering, terminal maneuvering) must be examined for driving conditions in structure design.  
 • Δ Castings is expected to be reduced in future as casting technology matures.  
 • Reduction in required factor of safety is expected as analysis accuracy improves will result in reduced missile weight / cost.

Figure 4. Missile Structural Design Is Driven by Safety.

- ◆ **Micro-machined Electro-Mechanical Systems (MEMS)**
  - ◆ Small size / low cost
  - ◆ Semiconductor manufacturing process
  - ◆ 2,000 to 5,000 sensors on a 5 inch silicon wafer
- ◆ **Missile Development Application**
  - ◆ Data Collection and Health Monitoring
- ◆ **Distributed Sensors Over Missile**
  - ◆ Stress / strain
  - ◆ Vibration
  - ◆ Acoustics
  - ◆ Temperature
  - ◆ Pressure
- ◆ **Allows Reduced Design Uncertainty / Factor of Safety**
  - ◆ Provides reduced weight and cost



Figure 5. Small Size MEMS Sensors Can Reduce Required Factor of Safety, Saving Missile Weight.

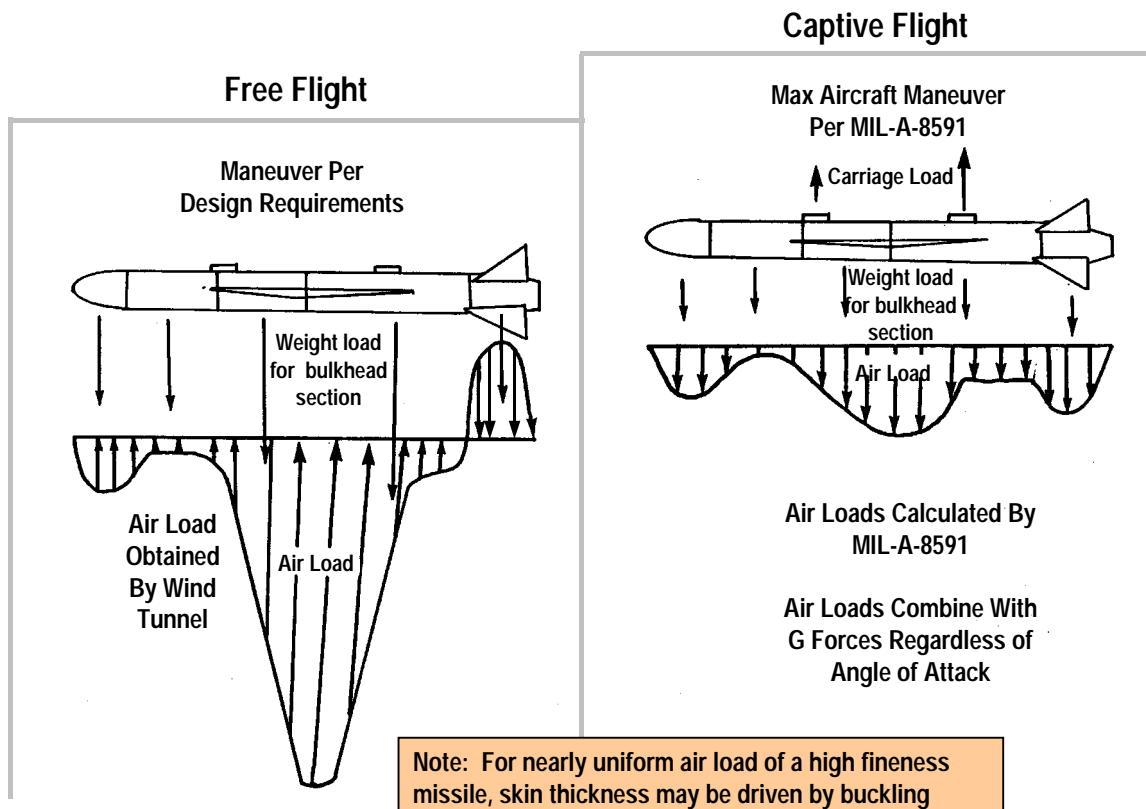

Figure 6. Process for Captive and Free Flight Loads Calculation.



Table 1. Robustness Is Required to Satisfy Storage and Aircraft Carriage Environmental Requirements.

**Environmental Parameter      Example of Environmental Requirement**

- ◆ Temperature      -60°F to 160°F
- ◆ Humidity          5% to 100%
- ◆ Rain                120 mm / hr
- ◆ Wind                100 km / hr steady  
150 km / hr gusts
- ◆ Salt fog            3 grams / mm<sup>2</sup> per year
- ◆ Vibration          10 g rms  
MIL STD 810, 648, 1670A
- ◆ Shock               Drop height 0.5 m  
100 g 10 ms, half sine wave  
MIL STD 810, 1670A
- ◆ Acoustic            160 dB









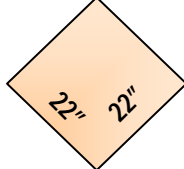

Launch Platform	Launcher	Maximum Body Shape	Maximum Length	Maximum Weight	
 Surface Ships	 Surface VLS	 Square Missile	256"	3400 lb	
 Submarines	 Sub-CLS	 Round Missile	256"	3400 lb	
 Aircraft	External Rail / Eject 	Internal Vert Eject 	Internal Trap Rail 	Internal Rotary 	~24" x 24"    ~168" ~500 lb to 3000 lb

Figure 7. Missile Shape, Size, and Weight Are Driven by Launch Platform Compatibility.

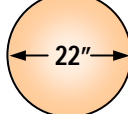
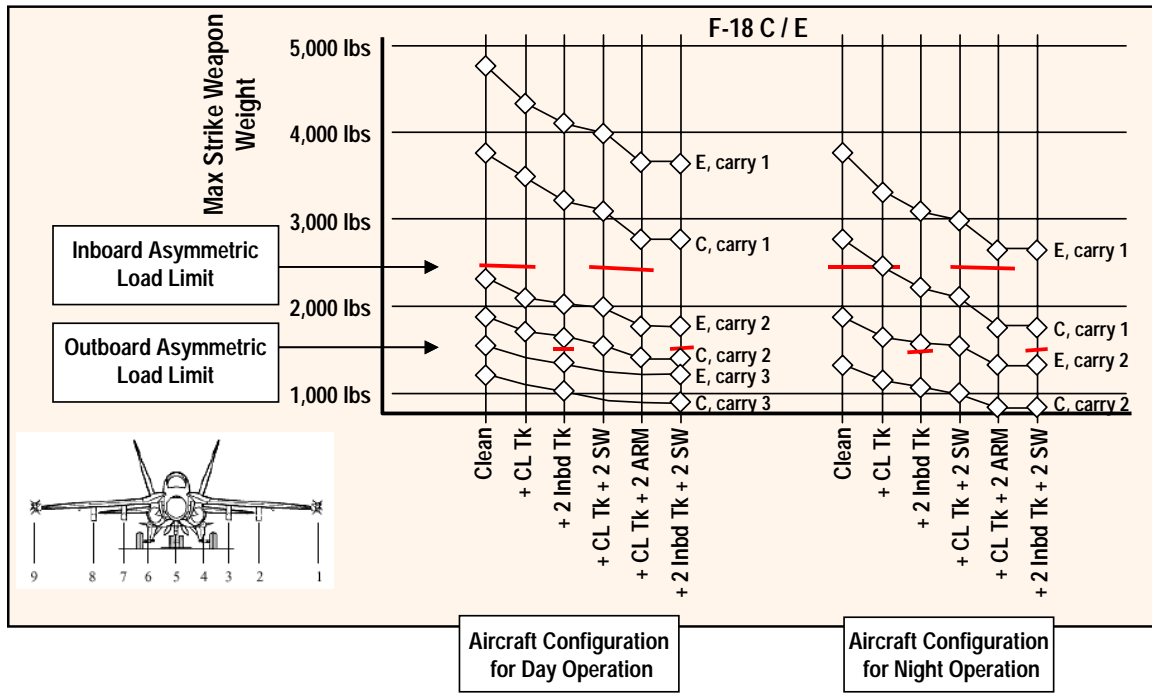

Figure 8. Light Missiles Enhance Firepower.

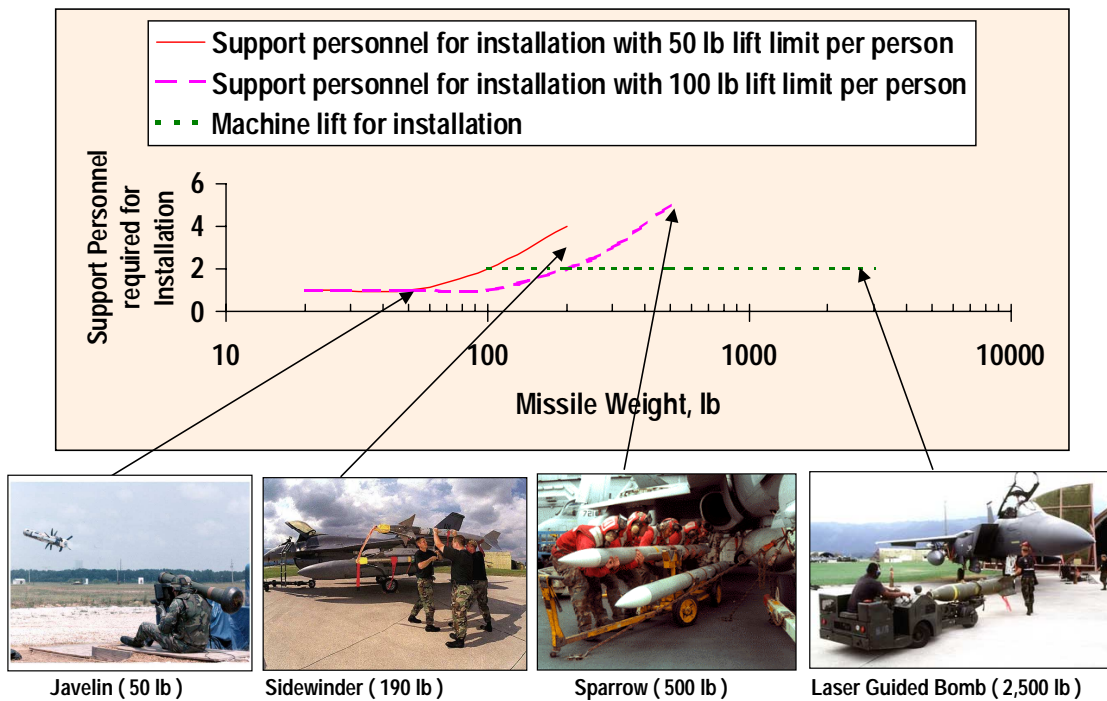
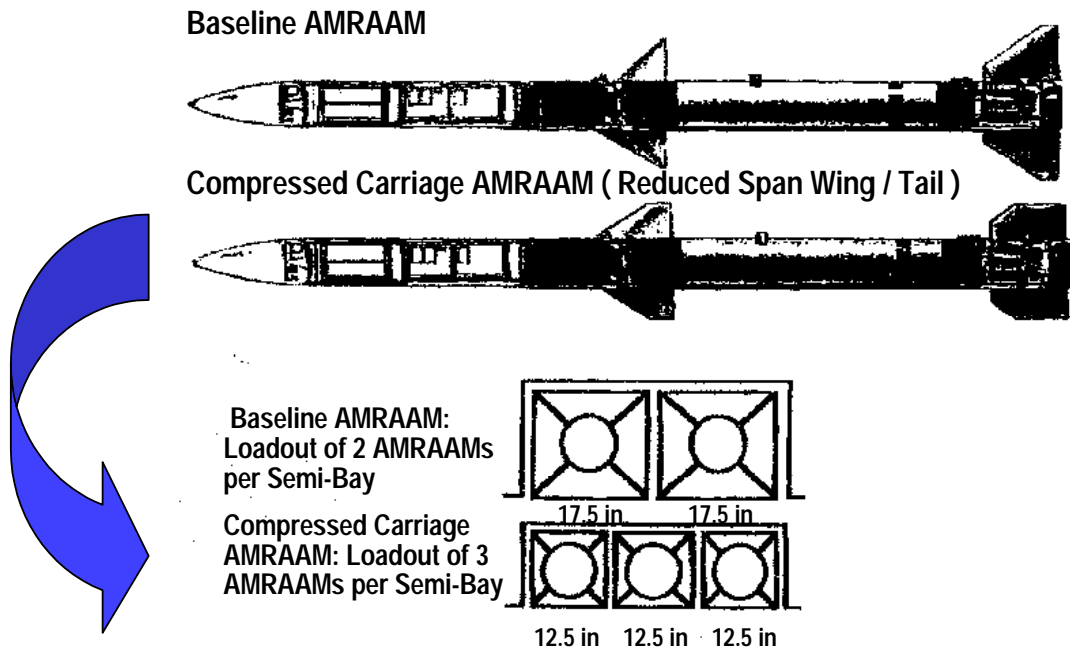

Figure 9. Logistics Is Simpler for Light Weight Missiles.



Alternative approaches to compressed carriage include surfaces with small span / longer chord, folded surfaces, wrap around surfaces, and switch blade surfaces.

Figure 10. Compressed Carriage Missiles Provide Higher Firepower for Aircraft with Internal Weapon Bays.

AGM-114 Hellfire: Helicopter Rail Launcher



AGM-88 HARM: Fighter Ejection Launcher



AGM-69 SRAM: Bomber Rotary Launcher



- Missile / Aircraft integration Launch Considerations
- ◆ Seeker field of regard ⇒ aircraft not obscuring
  - ◆ Launch rail clearance ⇒ miss at min range
  - ◆ Launcher aeroelasticity ⇒ miss at min range
  - ◆ Aircraft local flow field  $\alpha$ ,  $\beta$  ⇒ safe separation
  - ◆ Aircraft maneuvering ⇒ safe separation
  - ◆ Helo rotor downwash ⇒ miss at min range
  - ◆ Aircraft bay acoustics ⇒ missile factor of safety
  - ◆ Aircraft bay vibration ⇒ missile factor of safety

Figure 11. Precision Strike Missile/Aircraft Launch Integration Considerations.

Table 2. MIL-STD-8591 Ejection Launcher Requirements.

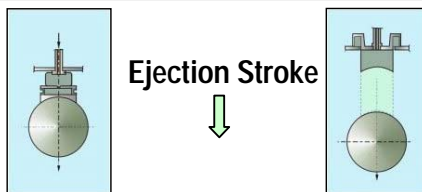
<u>Store Weight / Parameter</u>	<u>30 Inch Suspension</u>	<u>14 Inch Suspension</u>
<ul style="list-style-type: none"> <li>◆ Weight Up to 100 lb                             <ul style="list-style-type: none"> <li>• Lug height ( in )</li> <li>• Min ejector area ( in x in )</li> </ul> </li> </ul>	Not Applicable ↓	Yes 0.75 4.0 x 26.0
<ul style="list-style-type: none"> <li>◆ Weight 101 to 1,450 lb                             <ul style="list-style-type: none"> <li>• Lug height ( in )</li> <li>• Min lug well ( in )</li> <li>• Min ejector area ( in x in )</li> </ul> </li> </ul>	Yes 1.35 0.515 4.0 x 36.0	Yes 1.00 0.515 4.0 x 26.0
<ul style="list-style-type: none"> <li>◆ Weight Over 1,451 lb                             <ul style="list-style-type: none"> <li>• Lug height ( in )</li> <li>• Min lug well ( in )</li> <li>• Min ejector area ( in x in )</li> </ul> </li> </ul>	Yes 1.35 1.080 4.0 x 36.0	Not Applicable ↓

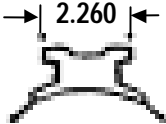
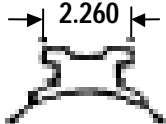
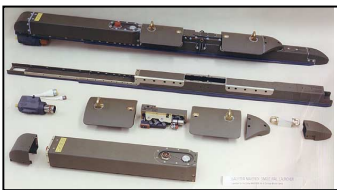

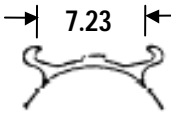
<b>Rail Launcher</b>	<b>Forward Hanger</b>	<b>Aft Hanger</b>
<b>LAU-7 Sidewinder Launcher</b> 		
<b>LAU 117 Maverick Launcher</b> 		

Note: Dimensions in inches.

- LAU 7 rail launched store weight and diameter limits are < 300 lb, < 7 in
- LAU 117 rail launched store weight and diameter limits are < 600 lb, < 10 in

Figure 12. MIL-STD-8591 Rail Launcher Examples.



F-18 Store Compatibility Test in AEDC 16T

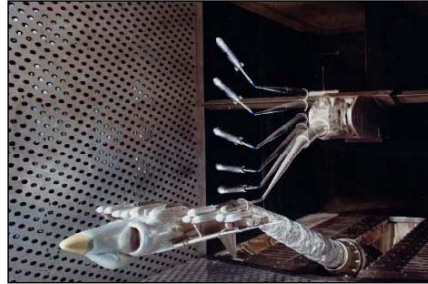

AV-8 Store Compatibility Test in AEDC 4T

**Types of Wind Tunnel Testing for Store Compatibility**

- Flow field mapping with probe
- Flow field mapping with store
- Captive trajectory simulation
- Drop testing

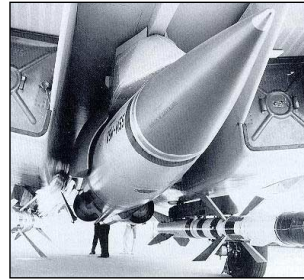

Example Stores with Flow Field Interaction: Kh-41 / AA-10

**Figure 13. Store Separation Wind Tunnel Tests Are Required for Missile/Aircraft Compatibility.**



AMRAAM Rail Launch from F-16



Laser Guided Bombs Drop from F-117



Rapid Bomb Drop from B-2

**Figure 14. Examples of Safe Store Separation.**

### Center Weapon Bay Best for Ejection Launchers



F-22 Bay Loadout: 2 AIM-120C, 1 GBU-32



F-117 Bay Loadout: 1 GBU-27, 1 GBU-10



B-1 Bay Loadout: 8 AGM-69

### Side Weapon Bay Best for Rail Launchers



F-22 Side Bay Loadout: 1 AIM-9



RAH-66 Side Bay Loadout: 1 AGM-114, 2 FIM-92, 4 Hydra 70

Figure 15. Weapon Internal Bay Carriage and Loadout Examples.

Table 3. Minimum Smoke Propellant Has Low Observables.

Type	$I_{SP}$ , Specific Impulse, sec	$\rho$ , Density, lb / in <sup>3</sup>	Burn Rate @ 1,000 psi, in / sec	Hazard	Observables
<ul style="list-style-type: none"> <li><b>Min Smoke.</b> No Al fuel or AP oxidizer. Nitramine XLDB (CL-20, ADN, HMX, RDX). Very low contrail (H<sub>2</sub>O).</li> </ul>	– 220 - 255	– 0.055 - 0.062	○ 0.25 - 1.0	–	◐
<ul style="list-style-type: none"> <li><b>Reduced Smoke.</b> No Al (binder fuel). AP oxidizer. Low contrail (HCl)</li> </ul>	○ 250 - 260	○ 0.062	◐ 0.1 - 1.5	○	○
<ul style="list-style-type: none"> <li><b>High Smoke.</b> Al fuel. AP oxidizer. High smoke (Al<sub>2</sub>O<sub>3</sub>).</li> </ul>	◐ 260 - 265	◐ 0.065	● 0.1 - 3.0	◐	–

● Superior   ◐ Above Average   ○ Average   – Below Average



High Smoke Example: AIM-7



Reduced Smoke Example: AIM-120



Minimum Smoke Example: Javelin

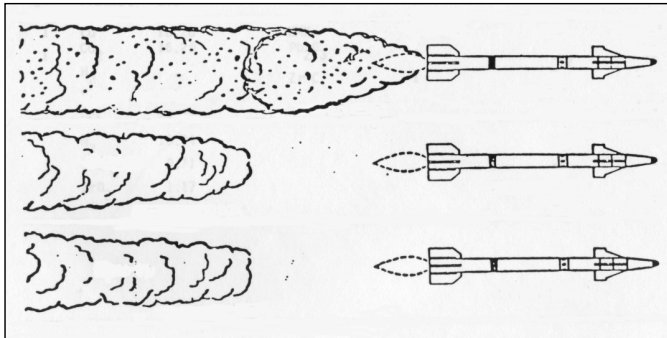

High Smoke: Particles ( e.g., metal fuel ) at all atmosphere temperature.

Reduced Smoke: Contrail (HCl from AP oxidizer) at < -10° Fahrenheit atmospheric temperature.

Minimum Smoke: Contrail (H<sub>2</sub>O) at < -35° Fahrenheit atmospheric temperature.

**Figure 16. Minimum Smoke Propellant Has Low Observables.**

**This page has been deliberately left blank**



**Page intentionnellement blanche**



# Simulation/Design Validation Technology

**Erik Berglund**

Swedish Defence Research Agency

172 90 Stockholm, Sweden

eberglund@foi.se

## Summary

Simulation plays an increasingly important role in the development of new missile systems. This paper contains a brief overview of the various types of simulation models used in different phases of design and evaluation. The main emphasis is placed on trajectory simulation models. The usefulness of different trajectory models for different purposes is treated. A recommendation is to avoid using more complicated models than are required to address the problem of interest. The problem of using a very limited number of test firings to validate a highly complex model is mentioned.

## Introduction

In the design of a new missile system, as well as in the development of tactics, modelling and simulation plays an increasingly important role. The main reason for this is, of course, to save money. The number of test firings, which are expensive, has declined and more of the system validation is now done using simulations. An example of this is given in table 1.

Modelling and simulation is a concept that includes many different aspects. Modelling and simulation of missiles can be used for many different purposes, e.g.:

- Concept studies and preliminary design
- System design
- Verification of system performance
- Assessment and analysis of systems
- Assessment and development of tactics
- Training of operators
- Threat assessment

Usually the models used in early design studies done by industry or in early studies by the government to define requirements are much simpler than the models used for final design and requirement verification.

In the development of a missile system it is common to develop a hierarchy of models from small subsystems to the entire system. All models are based on equations describing the relevant physical phenomena and on data describing the studied missile system.

Issues of vital importance to all models are verification and validation. Verification is the process to assure that the simulation programme is a true representation of the underlying physical model, while validation is the process to assure that the model is a good representation of reality, given the questions to be treated by the model.

The most relevant models for assessment of missile system performance and the transfer of data between the models are outlined in figure 1. The following text will mainly concentrate on trajectory simulation, missile system design, and verification of system performance.

## Trajectory Models

Trajectory simulation models can differ widely in complexity. They can be categorised according to several principles:

- 2D or 3D
- Linear or non-linear
- Kinematic or dynamic
- All digital or hardware-in-the-loop
- One-on-one or many-on-many

Practically all possible combinations given by the above alternatives can be used.

Below follows a discussion first on various types of one-on-one models and then on many-on-many models, mainly focused on the difficulties with choosing the correct measures of effectiveness (MoE). Textbooks on trajectory models include Zarchan.

### 2D or 3D Model

As a 2D model is significantly easier both to develop and to use, it must be recommended to start the modelling and simulation work with a 2D model. Further reasons for using 2D models are that in many cases most of the motion takes place in a plane and also that many roll stable missiles have weak cross coupling between the channels.

### Linear or Non-Linear

A missile model is highly non-linear in many of its parts. Yet linear models are often used for analysis and design. Advantages from using linear models include:

- Smaller model
- Super positioning applies, i.e. disturbances can be treated separately and their effects can be added.
- Standard design tools can be used for controller design.
- The method of adjoints can be used to calculate the effects of stochastic disturbances in an analytical way, thus avoiding the use of multiple Monte Carlo simulations.

Although linear models play an important part of controller design, more complex non-linear models have to be used to assess the performance of the missile and the control system.

Modern software, such as Matlab/Simulink, allows rapid linearisation of complex non-linear systems and provides an environment for design and simulation.

### Kinematic Models

A kinematic model is a model where motion takes place, but where the cause of the motion is not treated, i.e. the dynamics is not included. In a missile model this means that the missile follows an ideal trajectory according to the guidance law unless some imposed limits, such as maximal range, are reached.

Kinematic models can be used to obtain launch and intercept zones. Kinematic models do, however, not provide any miss distance.

Required data for a kinematic model include:

- Basic aerodynamics
- Thrust
- Guidance law
- Limitations such as
  - Maximal time of flight
  - Minimal velocity
  - Maximal angle of attack

- Maximal load factor
- Minimal closing velocity (for fusing)
- Field of view of command receiver or seeker
- Maximal tracking angular velocity

A launch zone, which is a typical result given by several runs of a kinematic model is shown in figure 2. Kinematic models can also be used to calculate no-escape zones. A no-escape zone is the subset of the launch zone, where a launched missile is guaranteed to hit even if the target evades with maximal acceleration. An example of a no-escape zone is given in figure 3.

The limited amount of data required by kinematic models make them well suited for preliminary analysis in the early stages of design and also for analysis of foreign, potentially hostile, systems.

### **Dynamic Models**

A dynamic model calculates the trajectory of the missile using Newton's equations of motion for a rigid body.

A dynamic model requires detailed data such as:

- Aerodynamics
- Thrust
- Guidance and control system
- Disturbances, e.g. measurement noise

The output from a dynamic model consists of time records of all variables, including the missile trajectory and also the point of impact or tile miss distance.

Dynamic models always contain transformations between coordinate systems. The missile dynamics is normally calculated in a missile body-fixed coordinate system. The missile velocities obtained in the body-fixed system are then transformed to an earth-fixed system where they are integrated to positions.

### **Hardware-in-the-loop**

Even though computer models have progressed very rapidly over the last decades, there is still a need for hardware-in-the-loop (HWIL) simulation. In HWIL simulations the normal approach is to use real hardware for the seeker in the missile and to use software to simulate the fly out of the missile. The seeker is mounted on a turn table in a room where the background signature can be carefully controlled (an anechoic chamber in the case of radar seekers). A target scenario is displayed for the seeker and the seeker output is fed into a digital model where the dynamics of the missile are simulated. The motion of the missile is then fed to the turn table, such that the seeker is moved in accordance to the simulated missile motion.

### **Many-on-many**

For assessments at a higher systems level many-on-many models are often used. A many-on-many model treats scenarios with more than one weapon on each side.

Assessment on higher levels is far more complicated than assessment on a one-on-one basis. The main reasons for this are that the system to be assessed contains not only technology but also humans and decision making, and also that it is much less clear what constitutes success.

An example of the difficulties of defining success can be taken from the Gulf War. The US Patriot surface-to-air missile was used to defend against attacking Scud missiles. The post war analysis has shown that the Patriots had very little, if any, effect on the incoming warheads. To conclude from this that the Patriot had no effect in the war is to make a severe error. Through television, millions of people all over the World could follow the Patriot missiles as they rose to the skies to ward off the incoming danger. By deploying Patriots to Saudi Arabia and Israel the US clearly showed concern for her allies' security. The conclusion is therefore that the Patriot had great effect, despite perhaps not scoring a single kill.

A further example of difficulties associated to many-on-many assessment can be taken from Berglund and Hansson. An assessment was made of a proposal to purchase a new and much improved surveillance radar to the Swedish Hawk surface-to-air missile system. The old system, called RBS77, had an old 2D radar with somewhat limited performance, while the proposed new system (RBS87) had a modern 3D radar with much better performance, not least in an environment with electronic warfare. The two systems were assessed in a many-on-many model, where several scenarios were used. The aggressor employed different weapons (iron bombs, guided missiles, stand-off weapons) and tactics (low or high altitude, defence suppression or not etc). All the scenarios were run with or without enemy use of electronic warfare. When the number of killed enemy aircraft was summed up, the result was according to table 2.

The surprising results motivated a closer look on the simulation results, which showed that the main reason for the results was that the main effect of the electronic jamming was to reduce the range of the surveillance radar. The reduced detection range resulted in missile launch at shorter range and consequently shorter times of flight. However the kill ratio per launched missile increased as the shorter time of flight resulted in less time for enemy counter measures such as manoeuvres. As most of the scenarios provided a target rich environment, the final result of the low performance radar and the enemy jamming was a high kill ratio. A conclusion is that kill ratio not was a good measure of effectiveness for assessment of the value of the modern radar.

A conclusion from the above example is also that great emphasis should be placed on the formulation of scenarios to reflect the questions to be treated and that the use of overly large and complicated models should be avoided. Qualified analysts are also needed throughout the process.

The choice of measure of effectiveness is further complicated by the changing nature of armed conflicts. While it was fairly straight forward to assess effectiveness in the major war that was envisioned during the Cold War, it is much more complicated in the broader range of conflicts envisioned today. Present and future conflicts are likely to take place in a peace time environment, where much of the focus is on public opinion and media relations. A weapon of today must not only disable the enemy, it must avoid collateral damage and it must also look good on television.

So far there has not been established any new set of relevant measures of effectiveness to reflect asymmetrical conflicts in a peace time environment.

## **Performance verification**

As was previously mentioned simulation models play a major part in the process of performance verification.

Presently there does not exist any established theory for how to verify the performance of a highly complex system given only a few real test firings and simulations. Some of the problems facing those working with verification and some of the present practice are outlined below.

In the development of a missile system the real physical system is usually developed in parallel with simulation models. This process is described in figure 4, perhaps following a more logical bottom up approach than is usually the case.

A detailed 6 degree of freedom trajectory simulation model is developed. The detailed model either contains detailed models of subsystems, such as the seeker, or simpler descriptions based on detailed submodels. The models of the subsystems are in each case validated against experiments and tests. A hierarchy of models is thus developed and the general hope is that models based on validated submodels have a good chance of being good representations of reality.

The number of real system tests, i.e. live test firings, is normally very small, perhaps less than 10. Data from the test firings are recorded and used both as a basis for model validation and as a basis for system performance verification. Simulations of the exact test firings are conducted and a comparison with the test

firings is made. The purpose of the comparison is to validate the model, but often some changes have to be added to the model. The model is then to be declared as valid, often by a government agency.

The next step is to use the model to simulate a large number of scenarios and to use the simulation results to verify system performance.

In this process of model validation and system performance verification there are many unsolved problems:

- How should a comparison between live firings and performance requirements be conducted given statistical properties and measurement quality?
- How should the live firings be compared to post-test simulations given statistical properties and measurement quality?
- Is it possible to use the test-firings both to update the model and to validate it?
- How should the scenario for the test firings be chosen?
- How many test firings are required given the complexity of the system?
- How should the results from test firings and simulation be compared to the performance requirements in order to verify the system performance?

As these questions currently remain unanswered it must be concluded that validation and verification despite great efforts still relies, at least to some extent, on faith. However, as experience shows that reasonable results are achieved through this process, there seems to be reasons to have faith.

## References

Assarsson A (ed.), *Robotkurs*, Defence Research Establishment, Stockholm, Sweden, 1996. (In Swedish)

Berglund E and Hansson MB, "Swedish experiences from air defense models", AIAA Paper 99-4025 presented at *AIAA Modeling and Simulation Technologies Conference*, Portland, Aug. 9-11, 1999.

Zarchan P, *Tactical and Strategic Missile Guidance*, Washington, DC: American Institute of Aeronautics and Astronautics, 1994.

**Table 1. Number of test firings during development and evaluation. (Data from British Aerospace)**

Year	Missile	Development	Evaluation	Total test firings	Simulation model
1951-58	Firestreak	209	94	303	None
1957-66	Red Top	77	40	117	Analog
1964-72	Martel	24	27	51	Hybrid
1973-78	Sky Flash	12	10	22	Digital

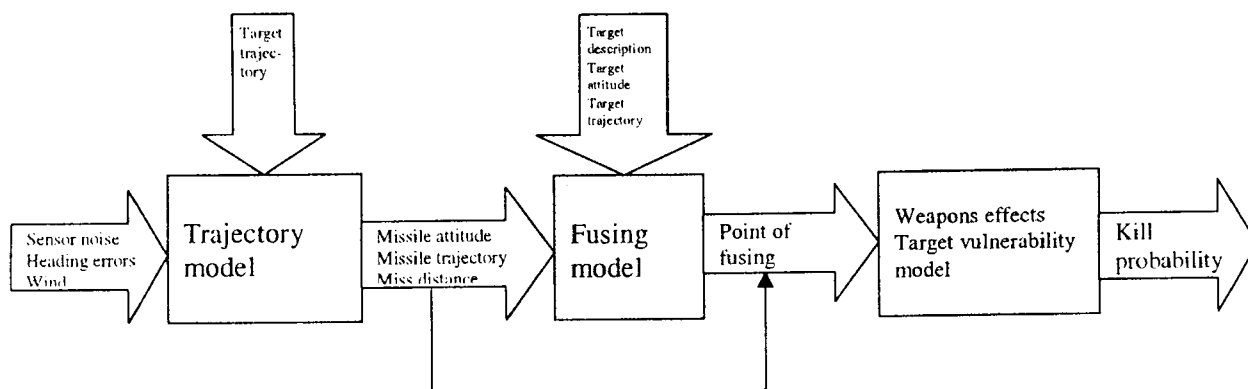

**Figure 1. Models for missile system assessment.**

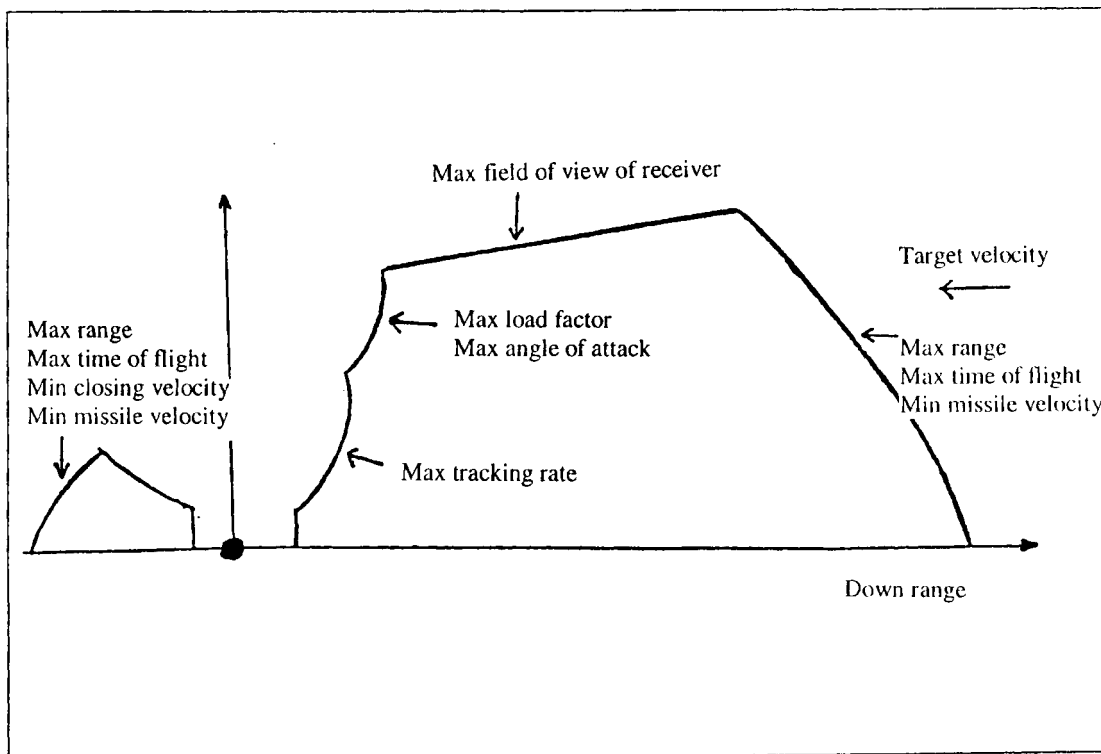

Figure 2. Launch zone for a typical line-of-sight guided surface-to-air missile. The limiting factors are noted.

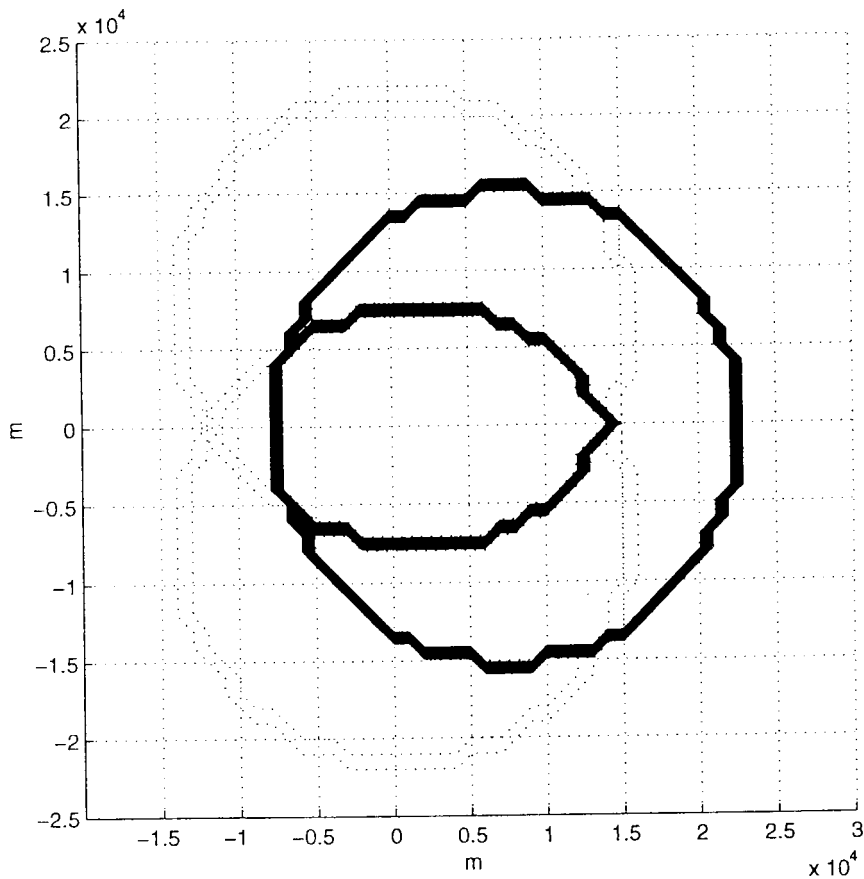
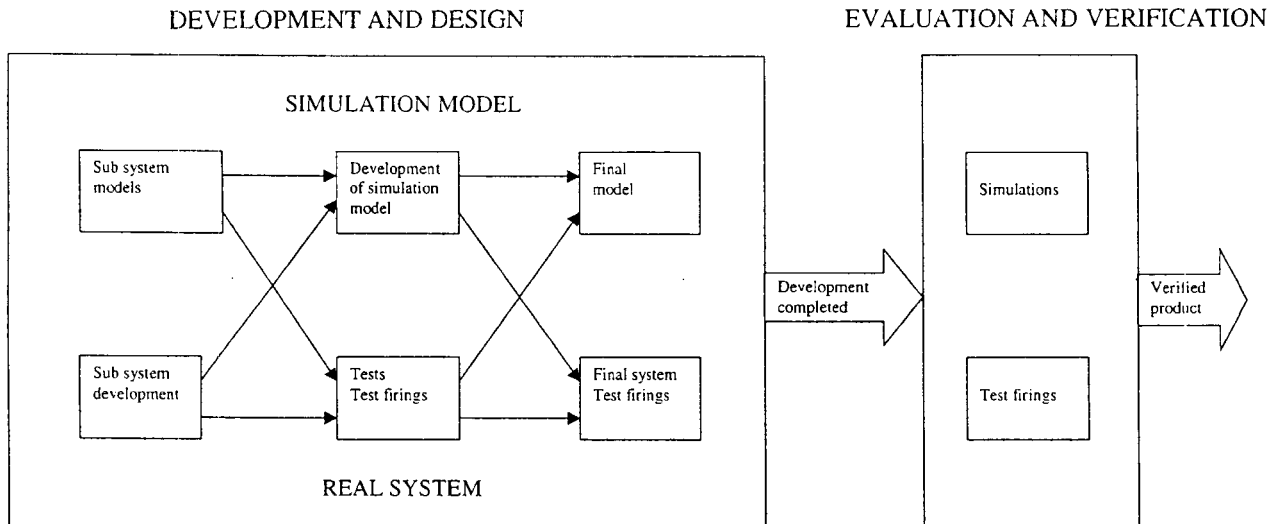

Figure 3. Example of no-escape zone (inner zone) and launch zone against a straight and level target for a surface-to-air missile using proportional navigation.

**Table 2. Kill ratios in scenarios with and without electronic warfare.**

	Kill ratio without enemy EW	Kill ratio with enemy EW
Old RBS77	59%	53%
New RBS87	58%	42%



**Figure 4. The principal development of real system and simulation models for system design and performance verification.**

**This page has been deliberately left blank**



**Page intentionnellement blanche**



# Automatic Target Recognition (ATR) Beyond the Year 2000

William H. Licata, Ph.D.  
Senior Principal Systems Engineer  
3590 New Heritage Drive  
Alpharetta, Ga 30022 US  
[770-475-2318/protono@ieee.org](mailto:770-475-2318/protono@ieee.org)

## Abstract

The goal of this paper is to project those video or picture based Automatic Target Recognition (ATR) systems likely to enter military inventories and alter mission planning in the year 2000 and beyond. Therefore, this paper avoids a discussion of specific technical approaches and their relative merits that often leads into proprietary or classified discussions. An emphasis is placed on the attributes of ATR as a military product and the factors that will determine the success or failure of efforts to move them in large quantities into military inventories. Some suggestions will be given on how the time to market can be shortened and where video ATR systems will first appear on the post cold war battlefield.

## Introduction

ATR in some form has been part of military systems for many years and some of these systems operate total autonomously. It is in the area of Video ATR (VATR) systems where the human operator has played an unchallenged role because of the large quantities of data that must be processed rapidly. Surpassing the ability of the human mind to recognize military objects on the battlefield is a difficult challenge. With the advent of small, affordable video computers spawned by a growing commercial market, the potential exists to replace human operators in, at least, a portion of those functions requiring video data processing and target recognition.

The author believes that an objective look at the recent history of efforts to develop ATR as a product and sell that product to the guided missile user community has proven largely unsuccessful. Some people point to a need for even faster computers that will appear each year and the need to incorporate modern computer interfaces between the weapons and the platforms that launch them. New aircraft such as the F-22 and Joint Strike Fighter (JSF) will certainly contain modern computer interfaces. All of these shortfalls impact the size of the ATR market but do not necessarily account for the growing view that systems recently tested don't validate the claims of their developers when tested in settings representative of modern battlefields. The author believes that too much effort has been spent on new approaches to ATR and this means new algorithms, software, plus testing of these algorithms. Too little time has been spent on the system engineering that helps define a product and its relationship to other products in a context that potential customers can make an informed buy decision. This paper treats the ATR as a system or product and explores the functions they perform, the needs they fill, and the ways they are intended to be used by the military community.

## ATR High Level Architecture

ATR can be thought of as a computer and software that tries to estimate what is the structure of the battlefield in front of the sensor based on three measurements; a.) knowledge of the transmitted or natural battlefield illumination, b.) observations of the reflected or emitted energy from the battlefield and c.) reconnaissance data about the battlefield. Figure 1 illustrates how the ATR uses all the data available to try and estimate the current state or makeup of the battlefield similar to the human observer. Because the ATR cannot process this information instantaneously, the data it provides the warfighter is late. This delay is more mission critical to a missile than an intelligence unit.

## Levels of ATR

Figure 2 illustrates the various levels of ATR depending on the type of sensor and to what degree the target is resolved into more than a single point. If the target is a single point, the ATR designer must struggle to find a discriminator other than size or textual content. If the target is the brightest object on the battlefield, a simple threshold test suffices which is normally called detection. Beyond brightness, the design must look for motion with time, brightness fluctuations or patterns of points in military type formations such as a convoy on a road. Point target recognition is in many ways the most difficult ATR problem but these types of ATR systems have been used for years on such weapons as radar guided, antiship missiles.

If the target is bigger than a point but cannot be resolved into recognizable patterns, the designer can still exploit the spatial extent of the blob and blob detection algorithms have been used for many years. Features such as height to width ratio or area can be effective discriminants. Classifying the type of target is however not possible by these measurements alone.

Recently with the advent of high resolution snapshot sensors like Synthetic Aperture Radar (SAR) or Imaging Infrared systems using detector arrays of thousands of detectors, sensors produce target pictures which the human observer can exploit very efficiently for precision man-in-loop guidance. With the explosion of the information content has come the difficulty of processing all this information and matching the tremendous ability of the human mind. As computers progress from being efficient manipulators of textual data, speech data, and very soon, picture data, the dawn of video based ATR appears to be only a matter of time. Although, it might even appear first in a commercial form rather than a restricted military form once a profitable commercial market develops.

## ATR As An Algorithm

ATR presentations are often centered around algorithm discussions. The algorithm is held to be highly proprietary and better than all other algorithms. The algorithm is the mathematics or recipe of the software design. As Figure 3 illustrates, there are a large and diverse number of algorithmic approaches to ATR. When mixes of these algorithms are considered, the number of choices becomes even larger. Each algorithm has its own group of advocates who may cluster around some academic discipline such as neural science, computer science, a branch of mathematics or some branch of engineering. Some even spawned new computer languages and processor designs. Prior to the dawn of algorithms as the core of ATR, high speed military processors were often found at the core but the decline in the market for military electronics compared to commercial electronics brought a rapid decline to the number of these processors. Often these special military processors were obsolete before they could find a home in a military product and corporations were unwilling to continuously invest in upgrades to both hardware and software tools with low expectation of achieving a significant return on investment.

## Fixed Target ATR

Figure 4 illustrates perhaps one of the less stressful ATR problems associated with strike warfare. Even this problem of finding a large building or bridge has only recently been considered solved, at least, by a portion of the ATR community. A large building is made up of edges and a template made up of a sufficient number of these edges can be sufficient to find an aimpoint by matching the edge template to the incoming sensor edge detected image. The problem is complicated by lack of knowledge about the missile approach angles to the target but fortunately GPS fills this information gap for fixed targets. In this mission area, GPS has come to the aid of ATR by reducing the workload for man-in-the-loop systems. Once the attention of ATR moves from large fixed target to moving or relocatable target ATR, the challenge remains high.

## Diversity of ATR

One of the aspects of ATR that complicates the transition from a technology to a product is the diversity of the ATR community as illustrated in Figure 5. Although, diversity is good in achieving technological breakthroughs, it is not necessarily good when it comes time to producing a marketable product that can be

sold for a profit. The algorithm designer always feels his algorithms need more tuning or new algorithms need to be added increasing the computational complexity. The target modeler can always build better models and the sensor designer can always improve the sensor performance. In this diverse community there is often a key person missing who is necessary to define a product and that is the ATR systems engineer. The ATR systems engineer understands requirements, specifications, acceptance testing, and “Cost as an Independent Variable.” The ATR technologist sees these concepts as separate from the ATR development and tasks that follow rather than lead the ATR design, which is not a product oriented view but technology oriented view. A need exists to grow ATR systems engineers to support the transition from technology to product. As Figure 6 illustrates, there has been growth in this area over the years as the need for increased funding levels and sustaining existing funding levels have altered the technologists view of ATR closer to a product.

## **Transition To A Product**

This paper has suggested that ATR is a technology on the verge of becoming a product. There is a threshold, however, that still needs to be crossed and unfulfilled expectations by customers may delay the time when the military crosses this threshold. Figure 7 illustrates the main pillars of the bridge required for ATR to cross this threshold and they center around the concept of being in the right place at the right time. A major military program will surface which needs ATR but might move forward without ATR if it isn't production ready. This is similar to past missile programs needing adverse weather performance but being unable to find radar seeker products providing that capability at an affordable price which have moved forward accepting only day-night performance. Mature ATR designs must be available and this implies software running in real time on an affordable processor that fits into the allocated volume. The willingness of customers to proceed will depend a great deal on how mission critical the need is for ATR and the strength of the acceptance testing which supports a production go ahead decision.

Since ATR designs revolve around software and a computer, there is good reason to expect ATR to find its first markets in the civilian area. Once these commercial products receive public recognition and approval, the military may find itself in a follower position or developing militarized versions of commercial products. The author believe this scenario is the most likely one since the commercial uses of ATR seem limitless and video computers are already becoming an affordable commercial product as the movie industry has proven with ever increasing levels of animation.

## **The Military Development Cycle**

What in the past has been the military ATR development cycle is illustrated in Figure 8. This cycle is not unlike other technologies waiting the time when they will transition into useful products. The cycle starts with a company hiring or promoting from within an algorithm expert who develops a non-real time simulation of his selection of an optimal approach to ATR. This software is often tested with synthetic imagery that allows tight control of the collection geometry and scenario. Once good performance has been achieved, a need develops to validate the software with imagery from a representative sensor for a particular mission area. A captive flight test of the sensor yields a test data set under somewhat controlled test conditions. If this step gives favorable results the software is moved into a real time processor but one that maybe larger than the application could accommodate. At this point, the government may test the ATR system and reach some conclusion as to its utility. The most likely outcome is a need to modify the algorithm and start the process over again. The number of cycles the process goes through depends on what new missile programs are on the horizon that might need this ATR product and the patience of funding sources.

## **ATR As A System**

The systems approach taken in the past to defining ATR as a system is centered on the “black box approach.” ATR was sold as a stand alone system only loosely tied to the sensor whose imagery it uses as an input to make a recognition decision. The impact of this black box approach and the arbitrary separation of the ATR function from the sensor function limits ATR system engineering to a computer and software trades space. When it becomes clear at a higher system level that trades need to be made between the complexity of the

ATR and the complexity of the sensor, it becomes a very painful process and often leads to an expensive sensor design. There are many reasons why a black box approach to designing an ATR product should be looked at with great skepticism. Almost always, the requirements, flowdown process results in sensor image quality requirements that insist on perfection in all circumstances.

When an ATR product advertises its value to a potential buyer, it normally concentrates on probability of acquisition and false alarm rate or false alarm density. An ATR system is a user of information so its probability of acquisition is only meaningful if the sensor can provide a good image and that condition doesn't occur with probability one. At times, the scenes or viewing conditions are such that no sensor will provide a good image.

Probability of acquisition is a function of several equally important factors and the equality claimed in Equation (1) is not at all obvious or has it been proven to be true.

$$\begin{aligned} \text{Prob}_{\text{acq}} [\text{Target in ATR Design Space, Sensor Image Quality at ATR Levels, Mission Planning Data Still} \\ \text{Current, User Operates ATR Correctly}] = \\ \text{Prob}[\text{Target in ATR Design Space}] * \\ \text{Prob}[\text{Sensor Image Quality at ATR Levels}] * \\ \text{Prob}[\text{Mission Planning Data Still Current}] * \\ \text{Prob}[\text{User Operates ATR Correctly}] \end{aligned}$$

All the factors that the final probability of acquisition depends on are very interrelated. The mission planner needs to know how the sensor and the ATR function. The problem does not nicely partition itself into four, five or more totally separate design problems and all of these factors must be included in the ATR design space.

## ATR Requirements

A complete set of ATR requirements must address more than probability of acquisition and false alarm rate. It must address system interfaces and input-output data including such factors as:

1. Inputs into the ATR system
2. Reconnaissance data required to plan a mission
3. Number and types of targets that must be recognized
4. Quality of data products needed
5. Sensor Performance
6. Output to the missile guidance computer
7. Maximum number targets in scene that can be processed
8. Estimate of target types - tank, truck, jeep, etc. that are in the design space
9. Accuracy of target measurements - length, width, area, angle
10. Computer required to host software – throughput and memory
11. Programming language
12. Type of acceptance testing to sell off a product

A complete set of ATR requirements must be addressed by the design similar to a hardware specification for a sensor system.

## Number of Pixels on the Target

One basic requirement for an ATR system is number of pixels on the target for the ATR system to achieve a specified level of performance. This number has been hard to extract from the ATR community. However, it is possible to perform a requirements level of analysis that indicates what is needed. Consider Figure 9 which shows one simple approach to answering this question. If the target of interest is a simple square which is N by N pixels of value 1 and it is embedded in a noisy image where the noise has value 0 or 1. This could correspond to an infrared sensor with signal to noise ratio of 1 or an image after edge detection. What is

important is the number of times the noise looks like a square, target. The plot on the right of Figure 9 was computed by passing a  $N \times N$  template over the  $256 \times 256$  image then computing the correlation. The plot shows the ratio between the target correlation and the largest noise correlation (false target). A ratio of 1 means you cannot tell the difference between a target and a false target. The plot shows that the target must be  $6 \times 6$  before there is any separation between target and false targets and even at  $8 \times 8$  the separation between targets and false targets is low. The  $8 \times 8$  number has been used at times as the capability of a human observer so this simple analysis correlates with this traditional threshold. More analysis such as this can add further insight into where to reasonably set the bar for ATR performance. In the past this has been a problem for users not knowing what is a reasonable design specification.

## Complexity of Template

Another important area where requirements need to be developed is in the area of template complexity. How much detail should be put into a target template. Consider Figure 10 that shows the edge detected image of the same building used previously. Underneath the edge detected image is a simple template created by extracting lines from the buildings in the image. One question that might be asked is the number of lines that should be used in the template. What the plot on the right illustrates is that the building only has a few line types (distribution of line angles relative to image horizontal) but the clutter has a continuous distribution of line types. The template match score goes up rapidly as you pick the first couple of line types, but after that, there is little increase in match score and adding more lines increases false target recognition more than true target recognition. This example problem illustrates why it is unlikely that any system can achieve zero false alarm rate since every target has something in common with the background and the military tries to increase this similarity using camouflage. The target in Figure 10 is so large, it is not easily missed but ATR must work at longer ranges and distinguish one building from another.

## Sensor and ATR Separability

A basic question that needs to be addressed is whether the ATR system and the sensor can be developed separately. As Figure 11 illustrates, this question revolves around whether the key performance parameters can be separated between sensor and ATR and whether the associated requirements can also be separated. It is the authors opinion that they cannot be separated in a real system or product and the two must be developed as an integrated seeker system. The interconnection between the two is too interdependent and design trades cannot be made for one without impacting the other design.

## ATR Detection Requirement

Many missile designers have become used to seeing a requirement for target detection. But ATR designers don't generally think in terms of detection as illustrated in Figure 12.

Recognition for an ATR designer is what detection is for a radar moving target indication designer. In a way detection is embedded in recognition and does not separate out into detection followed by recognition. The ATR designer starts his process by finding all those things in an image that could potentially be a target and these are points of interest rather than detections. Points of interest are sorted into valid targets, false alarms or are discarded as non-targets. The ATR system engineer views recognition as a higher level of detection bringing with it more information than target location.

## Variability in Mission Planning

Mission planning is a very important aspect of ATR and an area the ATR designer has very little control over how it is conducted. One past approach has been to try and design for the minimum requirements in the area of mission planning such as one picture of the target. As Figure 13 illustrates there is a great difference between stationary targets and moving targets. Stationary targets can be mapped, surveyed and characterized a long time advance of an actual mission. In this case the designer can perform a high degree of mission planning. Moving targets such as ships at sea are difficult to mission plan and the ATR system must be more robust. Moving targets are also more likely to be targets of opportunity where the warfighter encounters them

in the course of a mission not originally directed at them. It should be no surprise that ATR systems will enter the inventory first for stationary target before moving targets. Even with this being the case, mission planning will continue to be an area of constant trades between ATR needs and reconnaissance capabilities even for stationary targets.

In addition to finding ships at sea, armor targets represent a difficult target to mission plan as illustrated in Figure 14. There is a greater likelihood of a mix of friendly, civilian and enemy forces. Armor can be masked or hidden by trees, hills or buildings.

Although ships are normally always moving, armor can often be moving or stationary and rapidly change from one state to another. The functionality required for armor targets has more dimensions associated with it such as picking a lethal aimpoint or rejecting civilian or friendly vehicles.

One difficulty associated with recognizing armor targets that has increased with the end of the cold war is the numbers and types of armor. As figure 15 illustrates, they all have all have similar attributes (ie. treads, wheels, hatches, barrels, etc.) and it makes designing a target template difficult. If the distinguishing part of a target is masked and the common part is visible it can easily be assigned the wrong target type. A higher fidelity in processing is required for armor or the performance goals must be set lower than for large stationary targets.

## **Defining A Reasonable Set of ATR Requirements**

Before a company can pursue building, marketing and selling an ATR product with or without a warranty, a reasonable set of ATR requirements must be selected as illustrated in Figure 16. Considering the ATR design space or mission space, the product must be designed not for every mission or application but for a reasonable subset that a designer can satisfy and a systems engineer can define requirements that can be converted to acceptance tests. This requires the ATR developers to become focused on a narrow market and remain focused long enough to create a true product.

Not every mission area is ready for this product focus as illustrated in Table 1. Some mission areas such as finding camouflaged targets requires technological breakthroughs or near instantaneous reconnaissance data.

## **Trends in ATR Technology**

As shown in Figure 17 there are many technology trends in the ATR area but probably the one with the greatest attention is multisensor ATR that requires fusing data from multiple sensor systems that potentially operate at very different wavelengths. The impact of GPS has already been felt in the ATR community but even tighter coupling between ATR and GPS can be expected in the future. Treating ATR as a systems problems is a new trend and the author hopes one that will gain even greater interest because it is this trend that will lead to more of a product focus. Trends in the area of artificial intelligence and other new processing approaches have decreased some and now fall more in the category of another tool available to the ATR designer.

## **Future Weapons Employing ATR**

In the next millenium, ATR will reach the product phase and enter the military inventory. The most likely first significant introduction will be in the area of Strike Warfare for large fixed targets. This well especially become important in the long range destruction of an enemies air defense systems during the first few days of a military conflict. Although Synthetic Aperture Radar seekers are growing in maturity, ATR will be used first with the new generation of infrared seekers using high resolution, focal plane arrays. When cloud cover obscures the target, these weapons will rely on GPS to get to the target area and then acquire the target just beneath the cloud cover. Missiles such as these will have a minimum useable cloud cover since the missile has a limited maneuverability. This may even create a need for airframes with higher maneuverability in the end game. Ballistic missile defense is another area where ATR will have some early success since targets are

easier to find above the clouds and against a clear sky background. These systems will use infrared and millimeter wave seekers. The emphasis in these applications will be on recognizing a lethal aimpoint.

Deployment of anti-armor seekers using ATR will be restricted to targets in the open and this means dual mode seekers using laser acquisition for more stressful target scenarios. Because anti-armor missiles traditionally have small warheads, aimpoint determination will continue to be a key figure of merit for these systems. ATR guided weapons for use against relocatable missile launchers will be slower coming because of the greater difficulty of the problem and the need for synthetic aperture radar seekers and new types to missiles which fly at hypersonic speeds to reduce time-to-target.

## Summary and Conclusions

It can be expected that the next millenium will be an exciting time for ATR systems as high speed video processors reach the commercial marketplace and video software development tools rapidly become common place. ATR technology can be expected to transition from technology to product. The first applications will be in the area of strike warfare against large fixed targets and air defense installations but anti-armor systems will follow shortly after. These first systems will encounter difficulties caused by the complexity of the ATR problem, lack of adequate user training and the growing unpredictability of the post cold war battlefield. The author believes that this process can be accelerated by more of an integrated seeker approach and the training of ATR seeker systems engineers who can define product requirements and key system design trades. ATR must move from a "Algorithm Centered World" to a "Product Centered World."

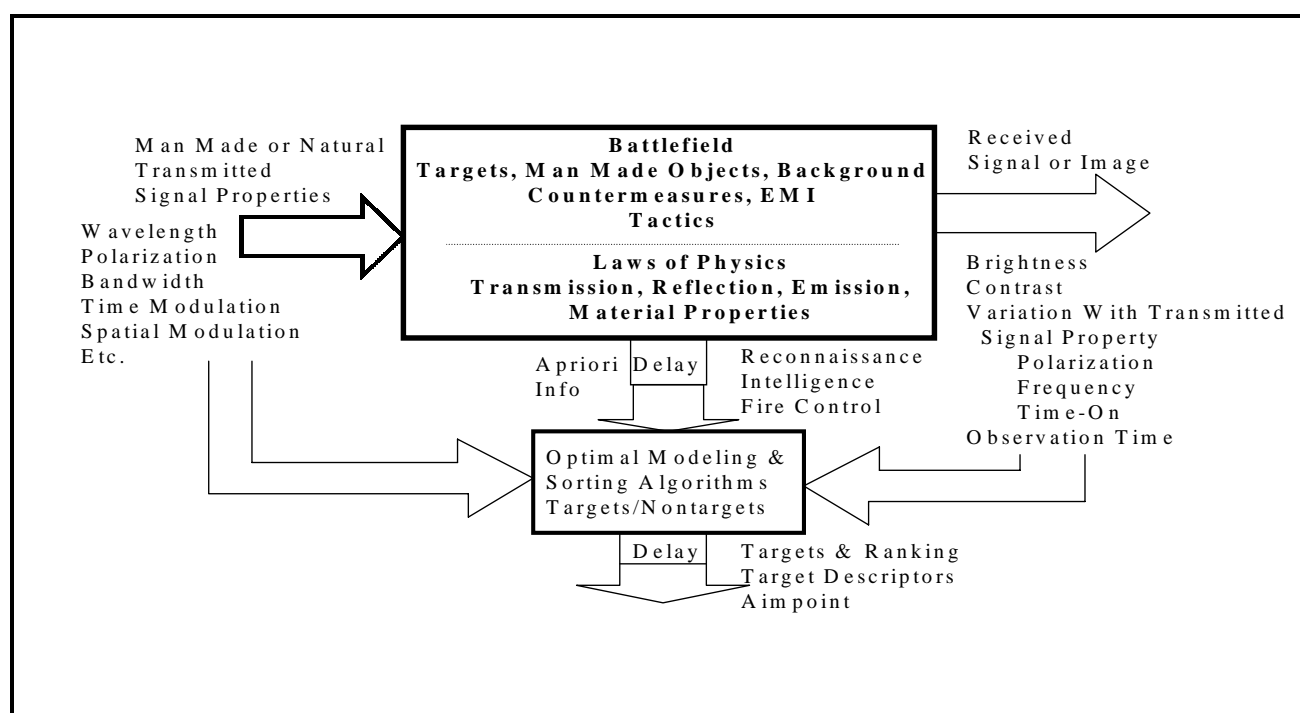

Figure 1. ATR High Level Architecture

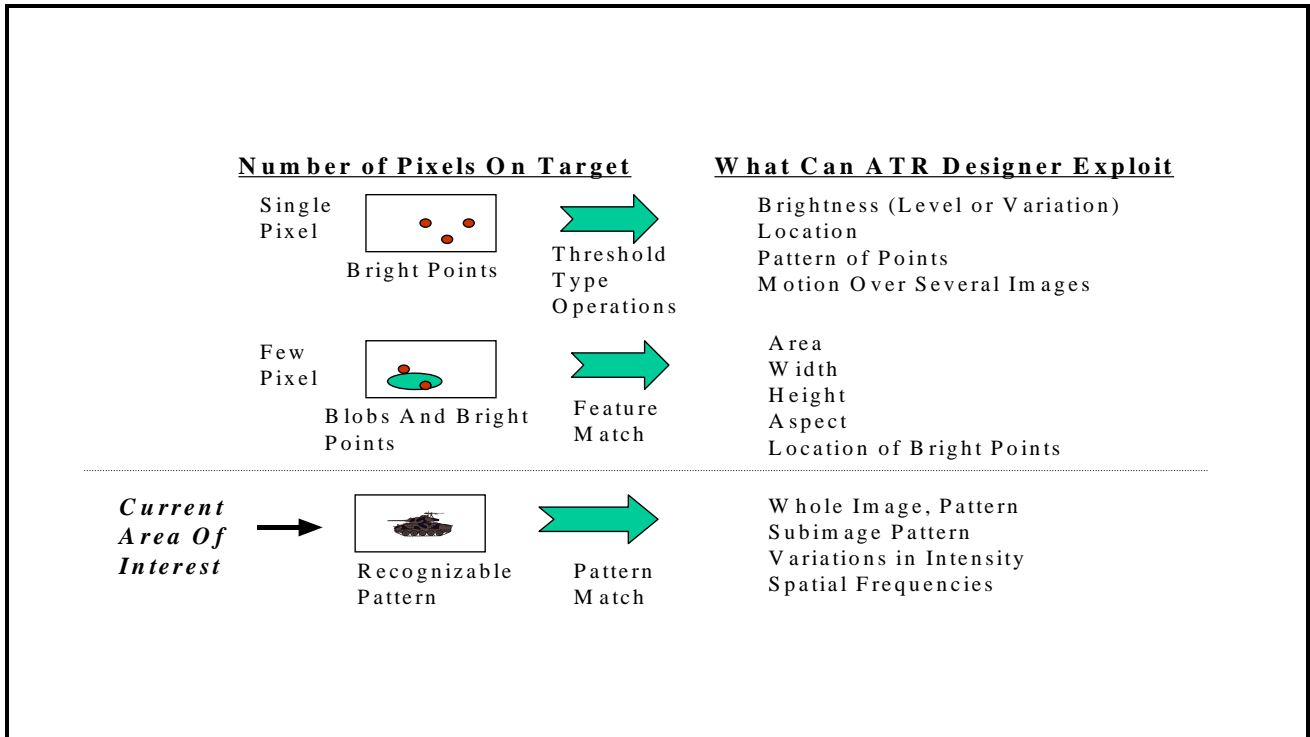

Figure 2. Levels of ATR

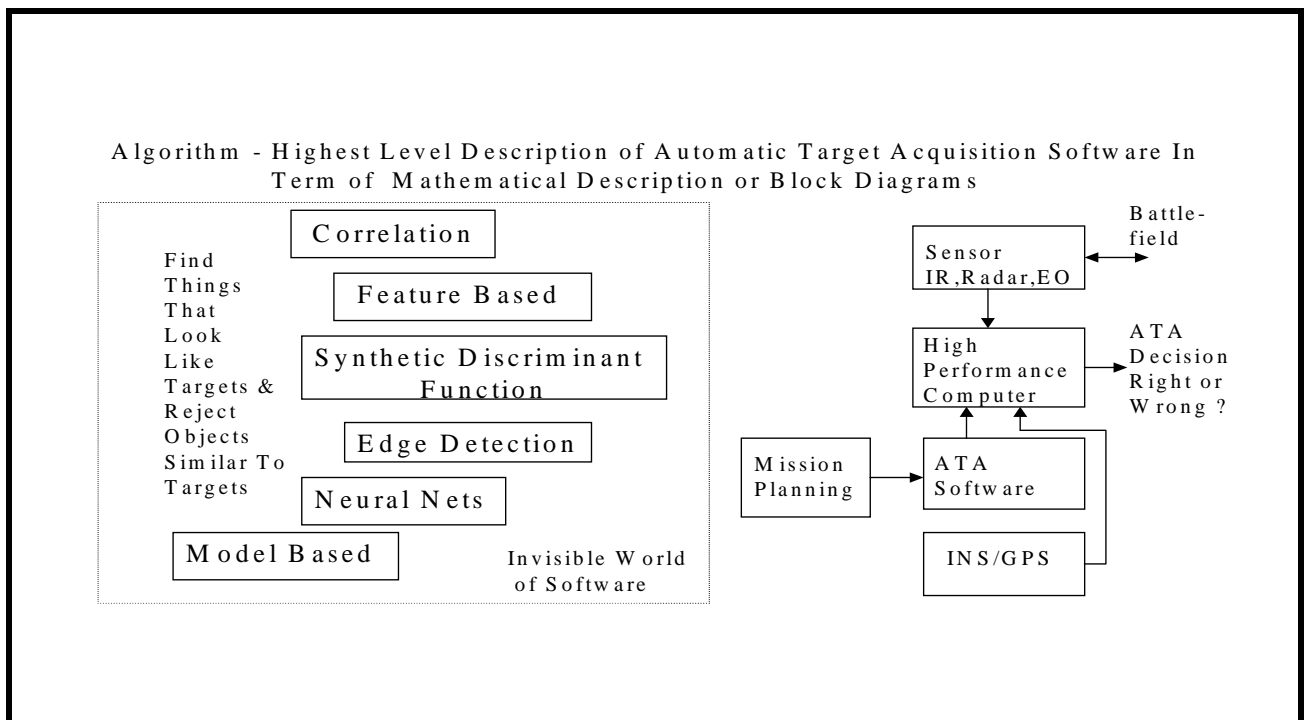

Figure 3. ATR Algorithms



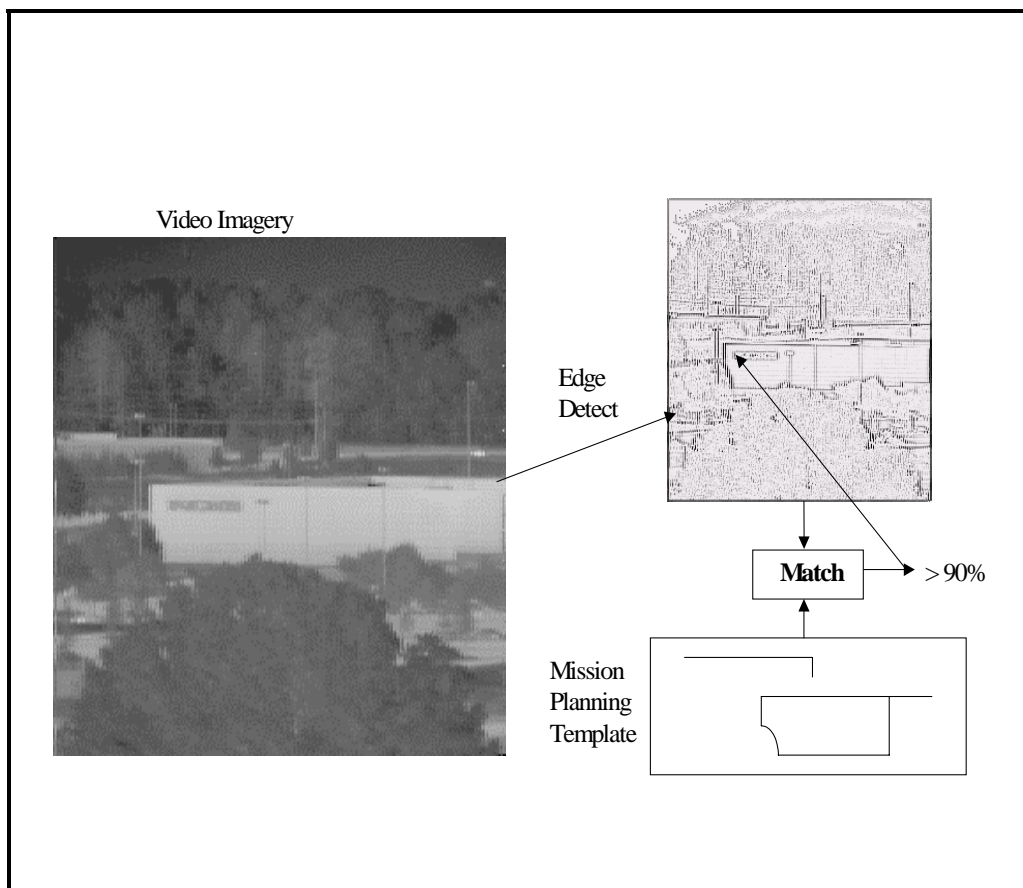

Figure 4. Standoff Weapon ATR

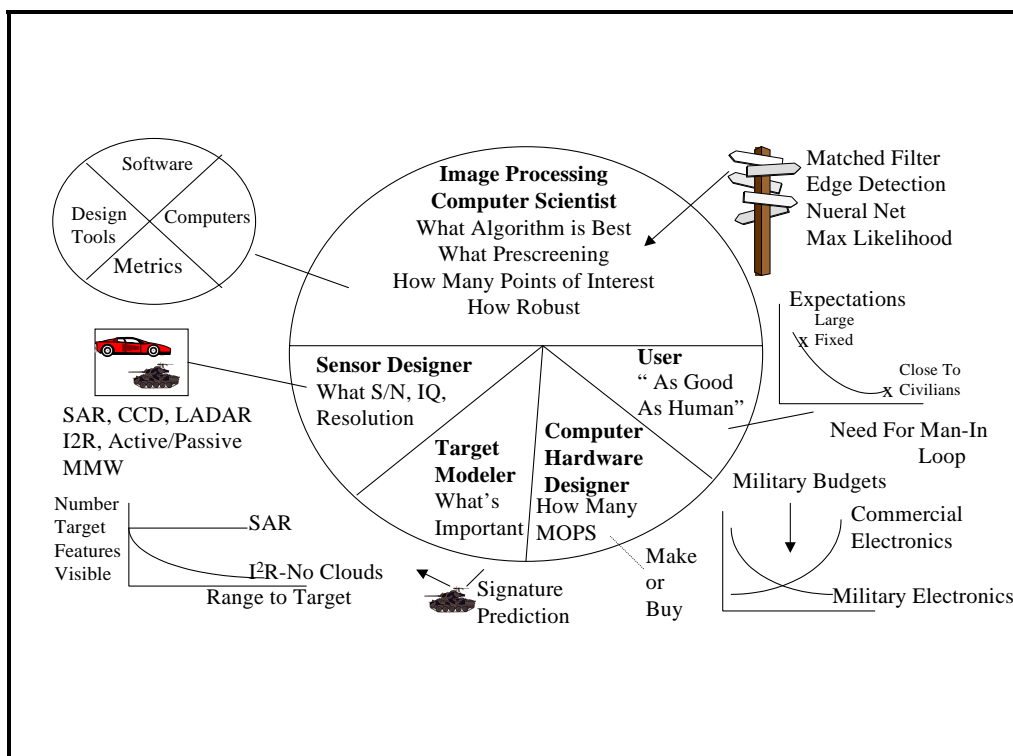

Figure 5. Diversity In ATR Community

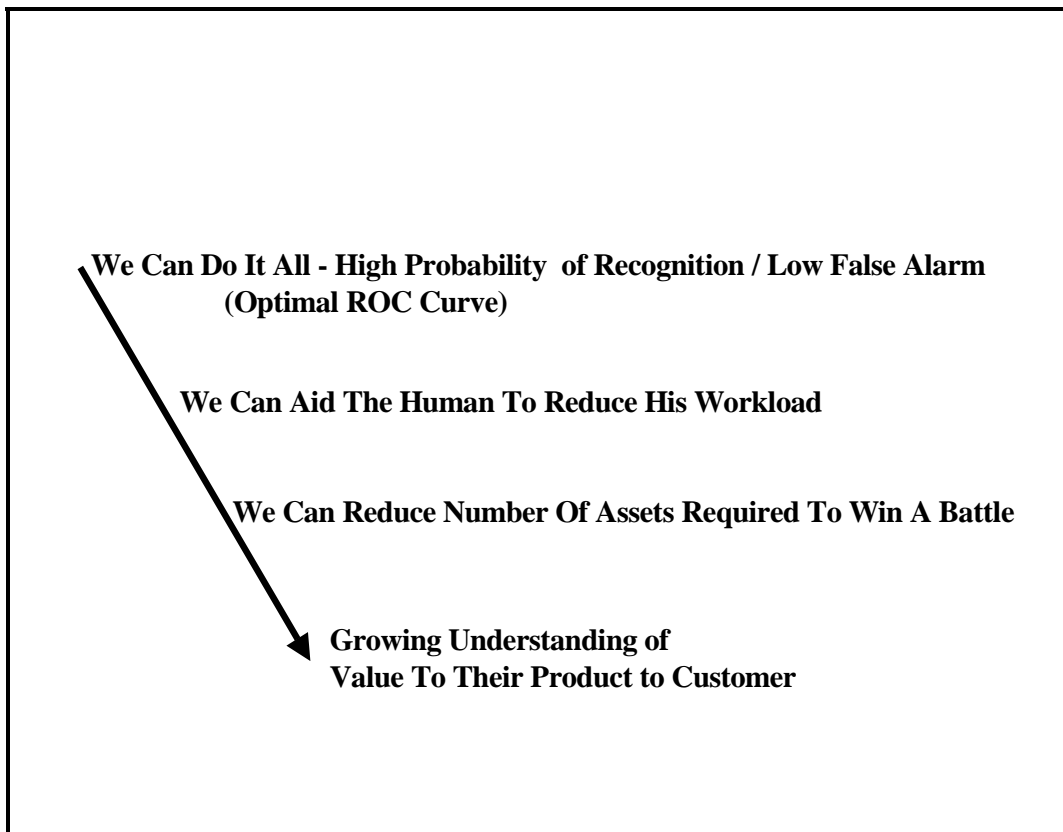

Figure 6. ATR Changing Vision of Benefits

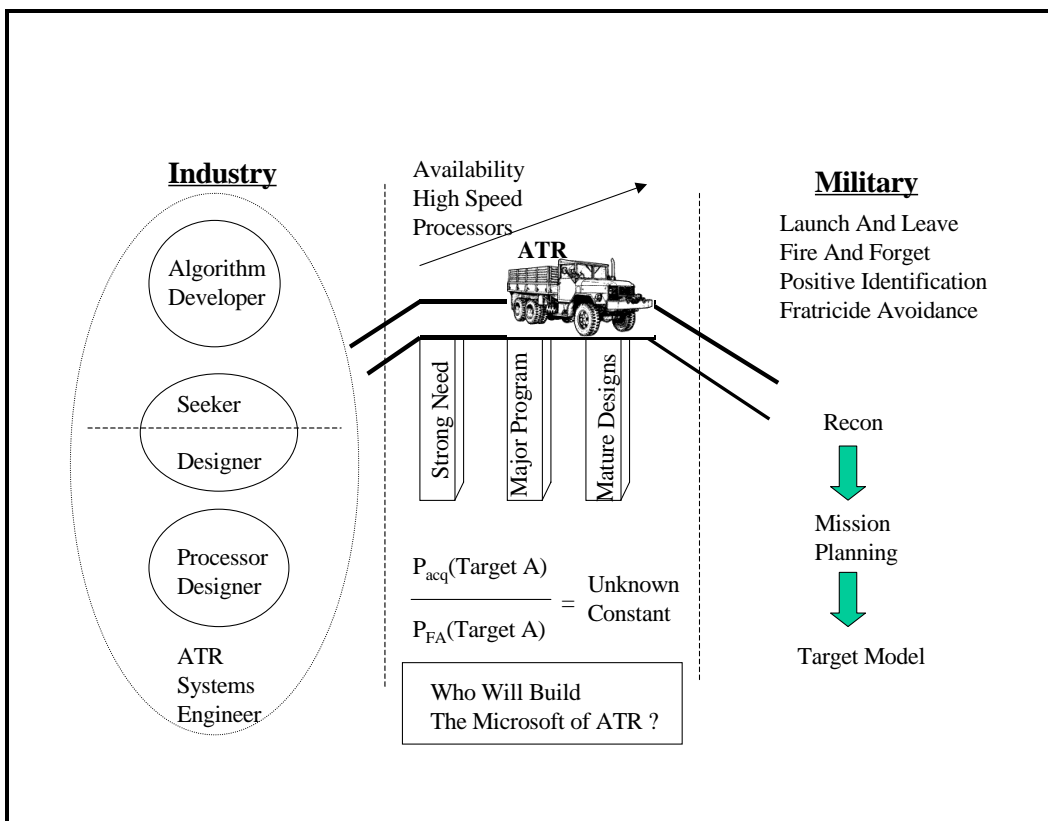

Figure 7. Transitioning To a Product

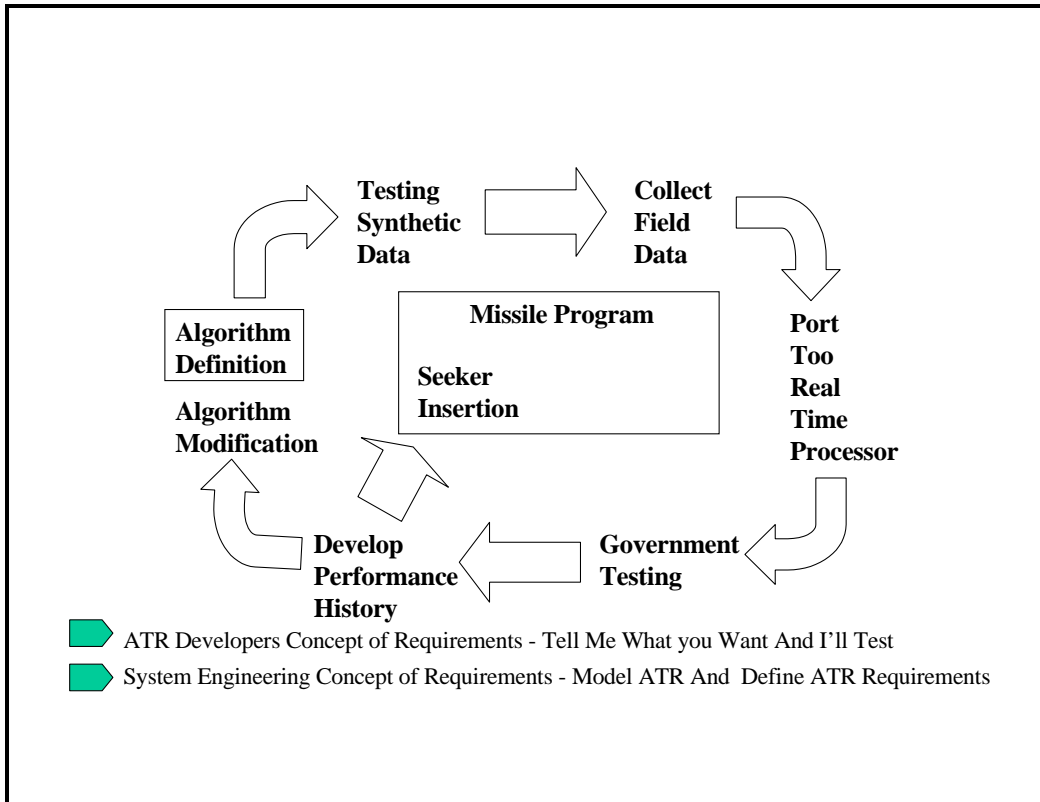

Figure 8. ATR Development Cycle

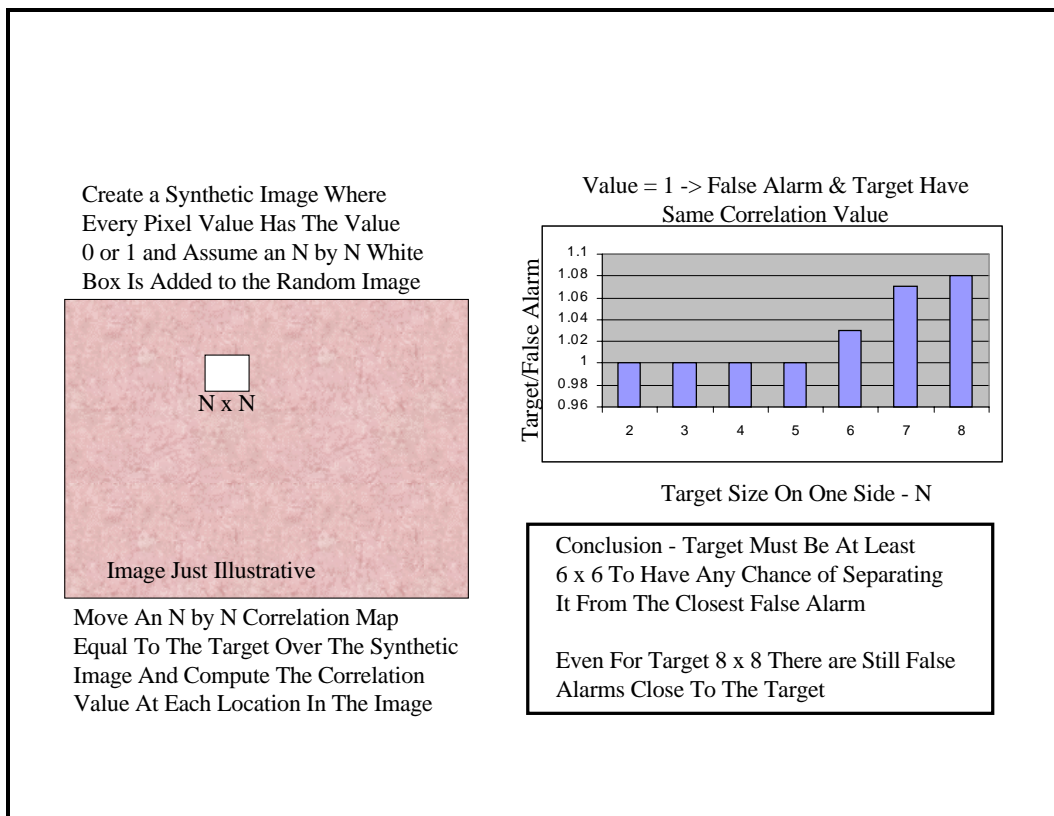

Figure 9. Number of Pixels on Target

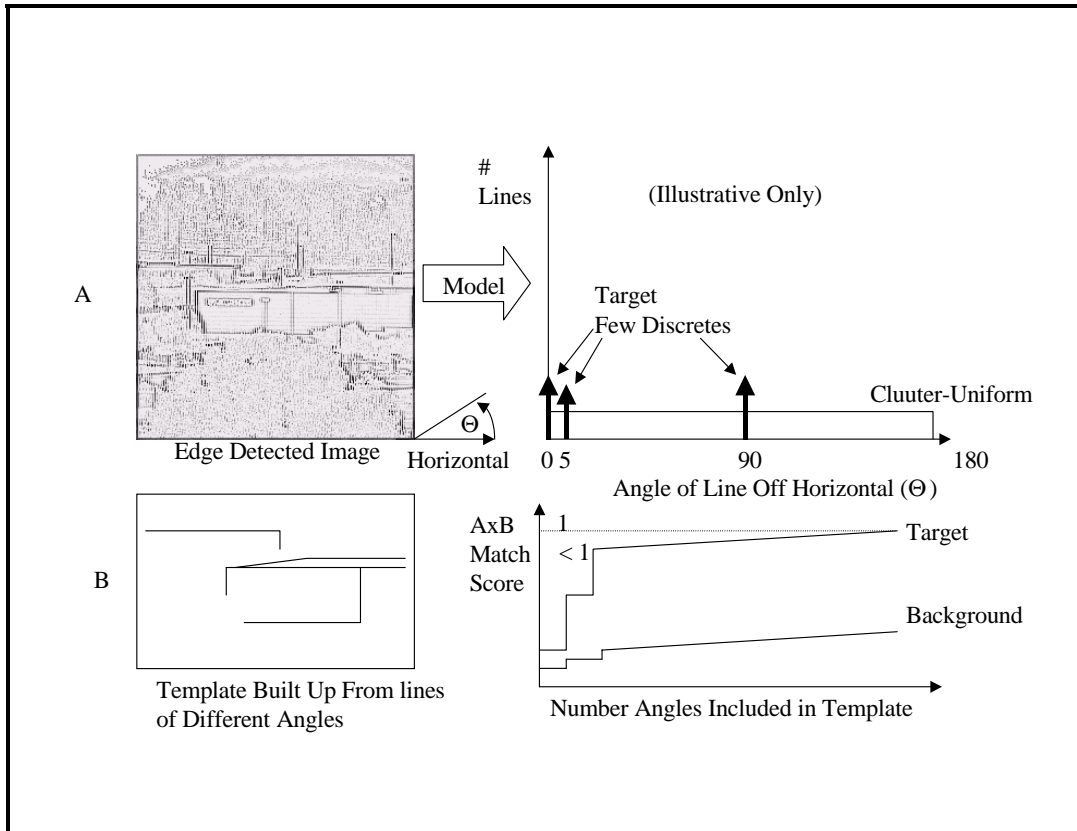

Figure 10. Template Complexity

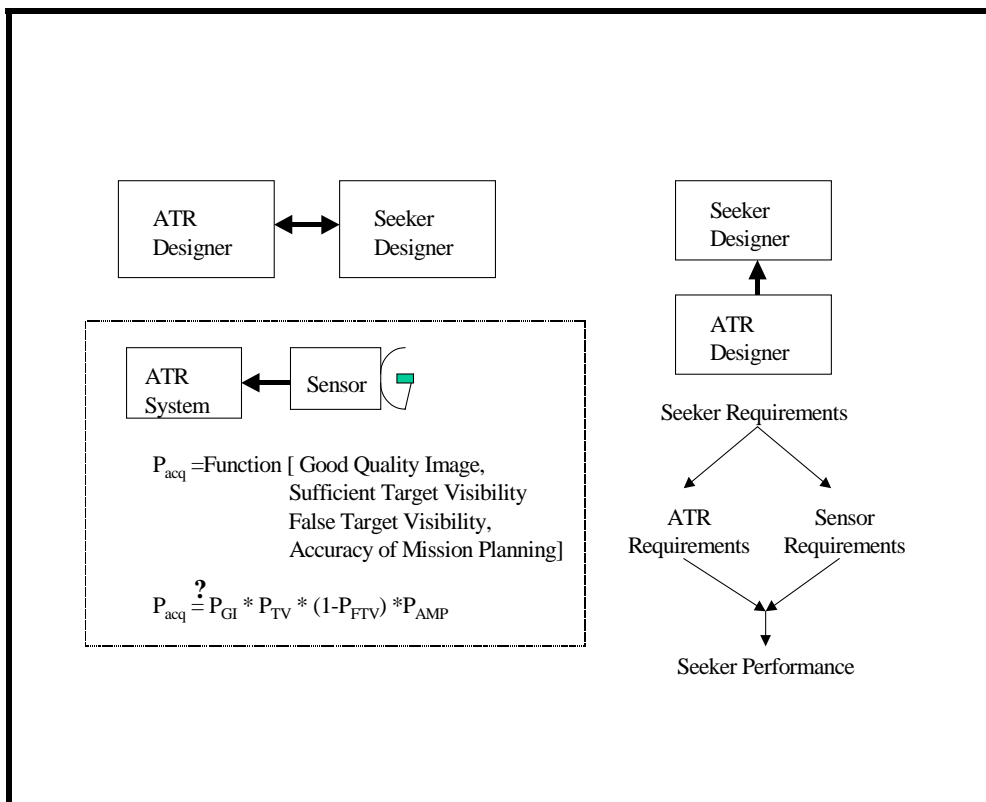

Figure 11. Sensor and ATR Separability

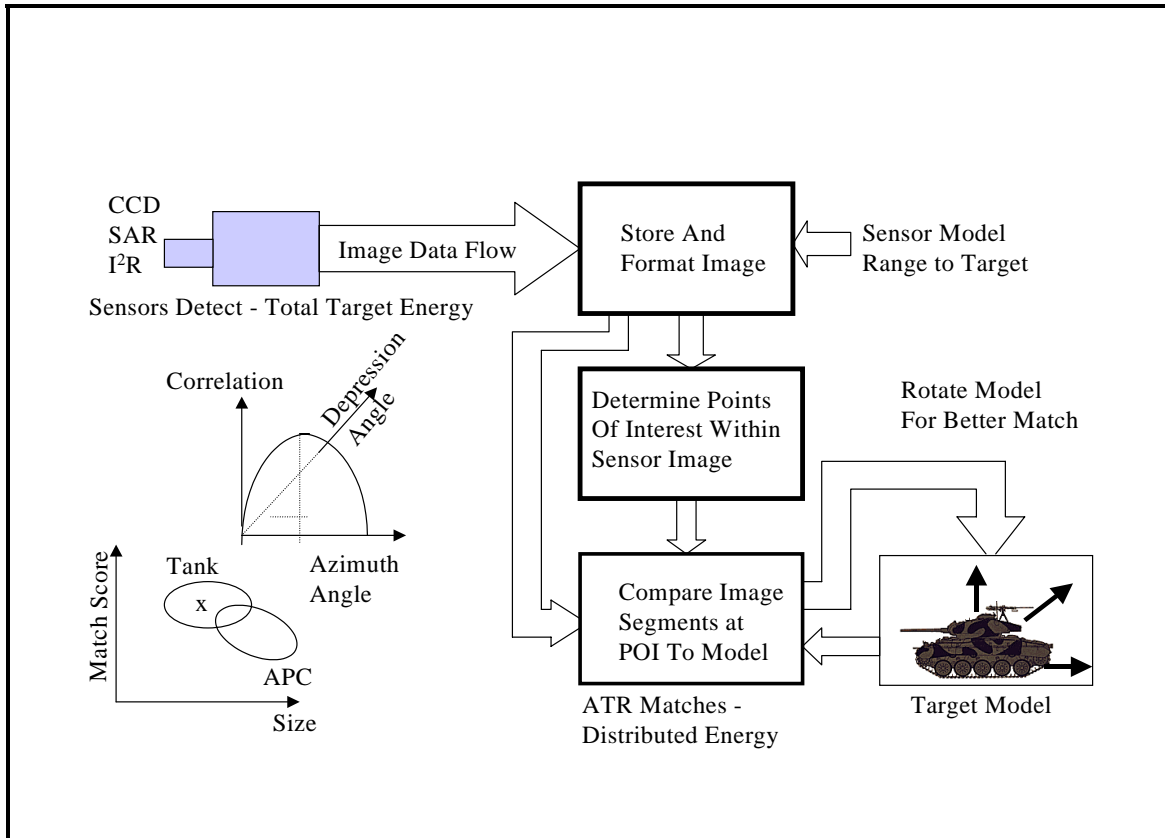

Figure 12. Detection in an ATR System

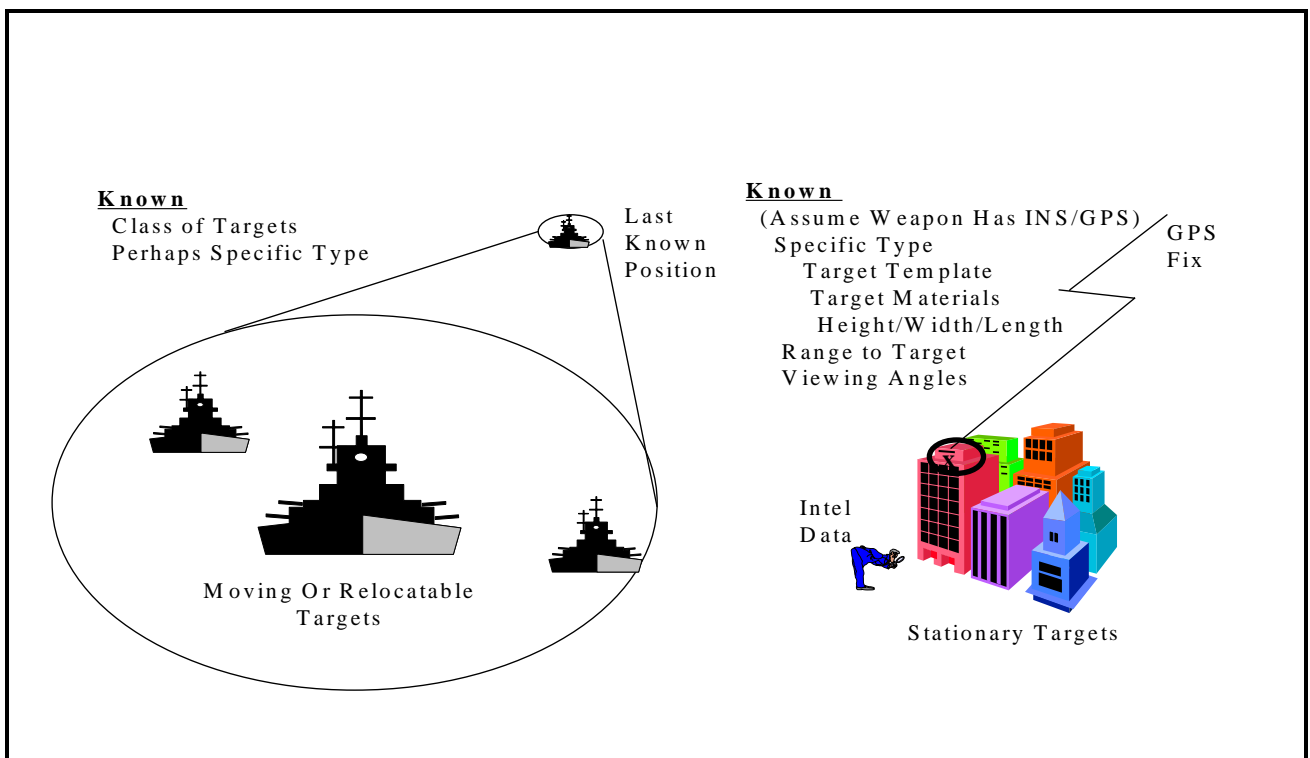

Figure 13. Mission Planning Variability

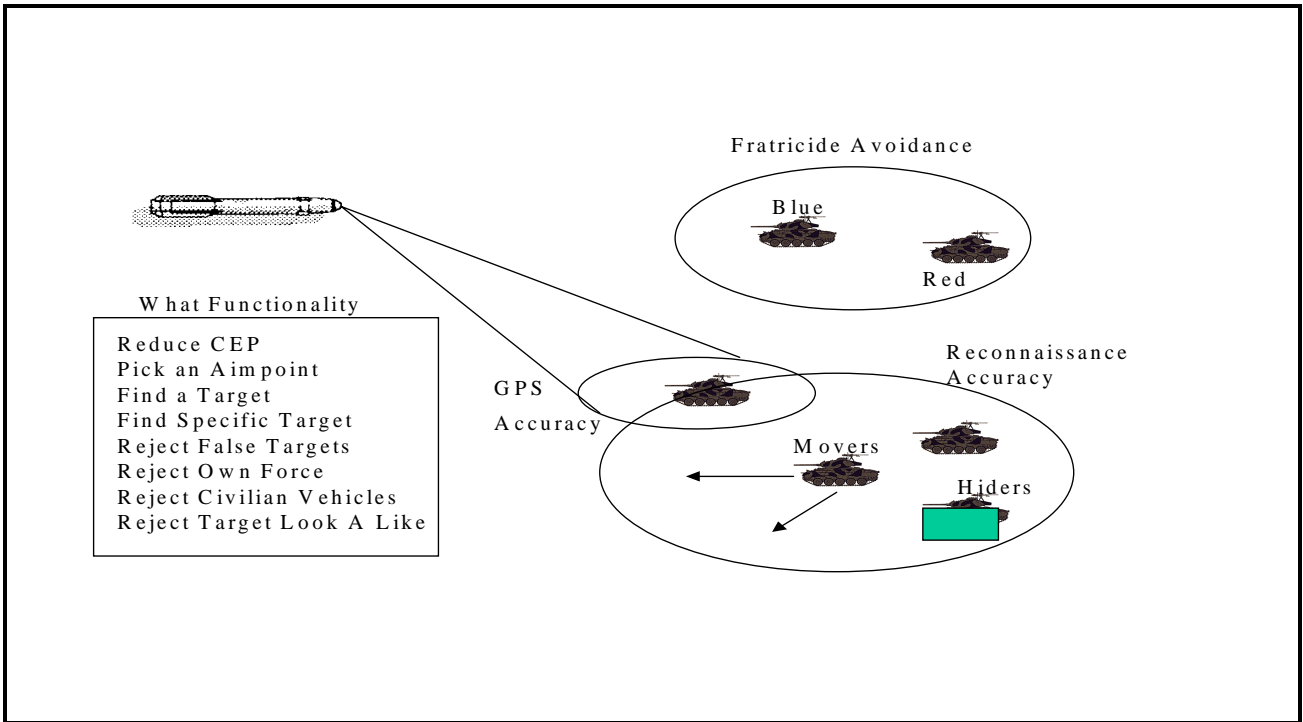

Figure 14. Armor Target

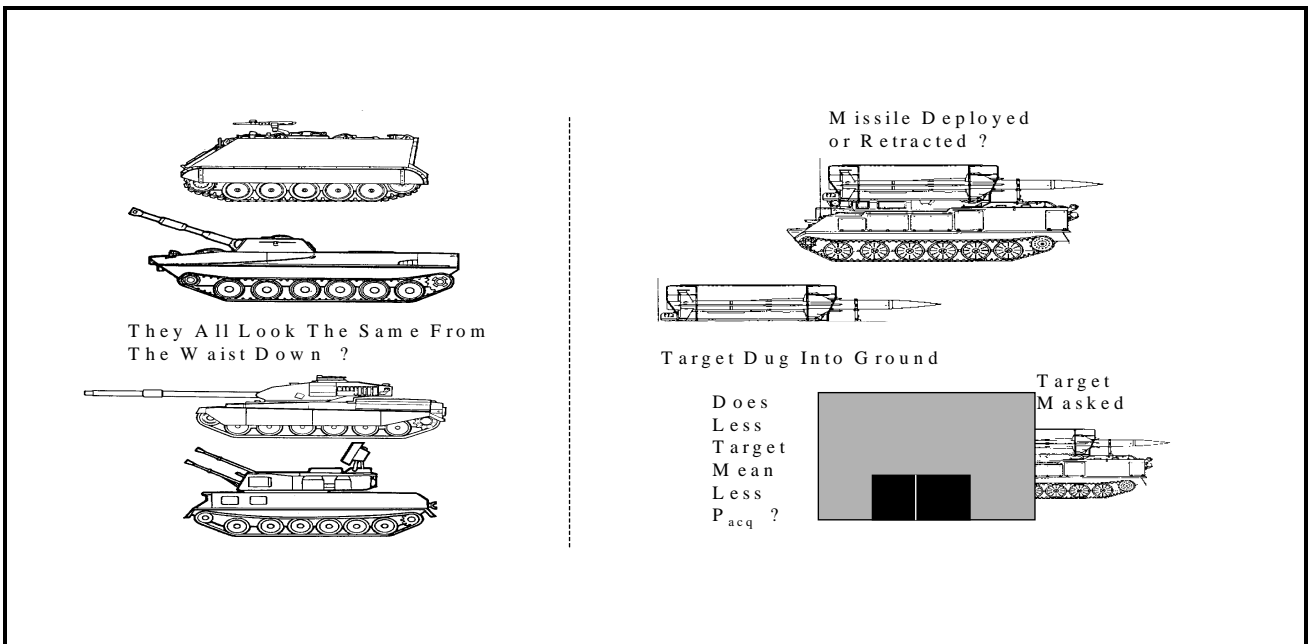

Figure 15. Variability in Armor Targets

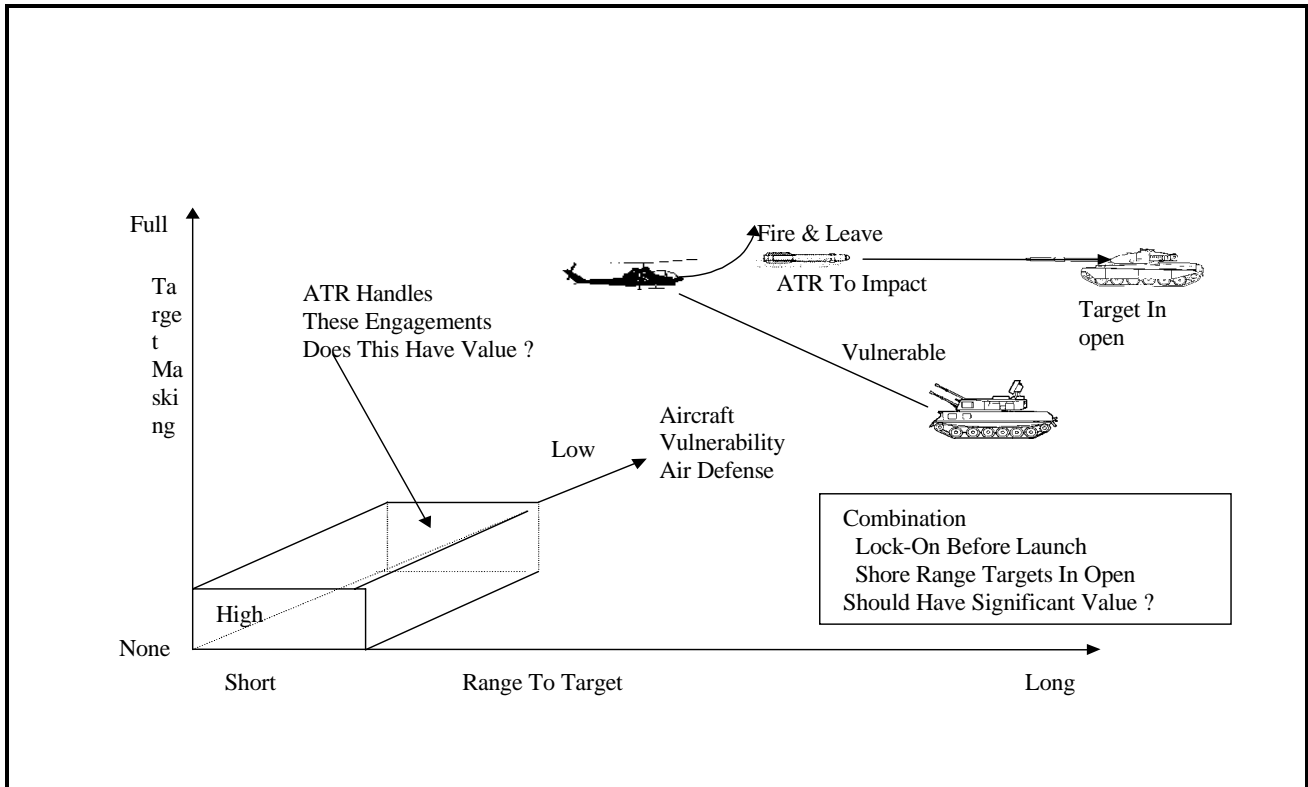

Figure 16. Bounding The ATR Requirements

Table 1. Mission Area Maturity

Requirements & Targets		Fixed Target		Moving Or Relocatable	
		Large	Small	Not Obscured	Obscured
Good Weather	No Countermeasures	INS/GPS Has Made This Practical	Stress Weapon Maneuverability	Faster Processors & Timely Cueing	Fine Resolution Sensors
	Countermeasures GPS Jammig Sensor Jamming Deception High Probability Obscuration	Multisensor Fusion Systems	Requires Sensor Development And Higher Weapon Maneuverability	Requires Development Of Multisensor Fusion Systems	Multisensor Fusion Systems And Fine Resolution
Adverse Weather	Cloud Cover	Faster Processors	Faster Processors & Higher Resolution	Rapid ATR & Sensor Search	Rapid ATR & Sensor Search Plus Fine Resolution
	Worst Day Of The Battle	Sensors That Are Not Weather Limited	High Resolution Sensors Not Weather Limited	Sensors That Are Not Weather Limited	Fine Resolution Sensors That Are Not Weather Limited

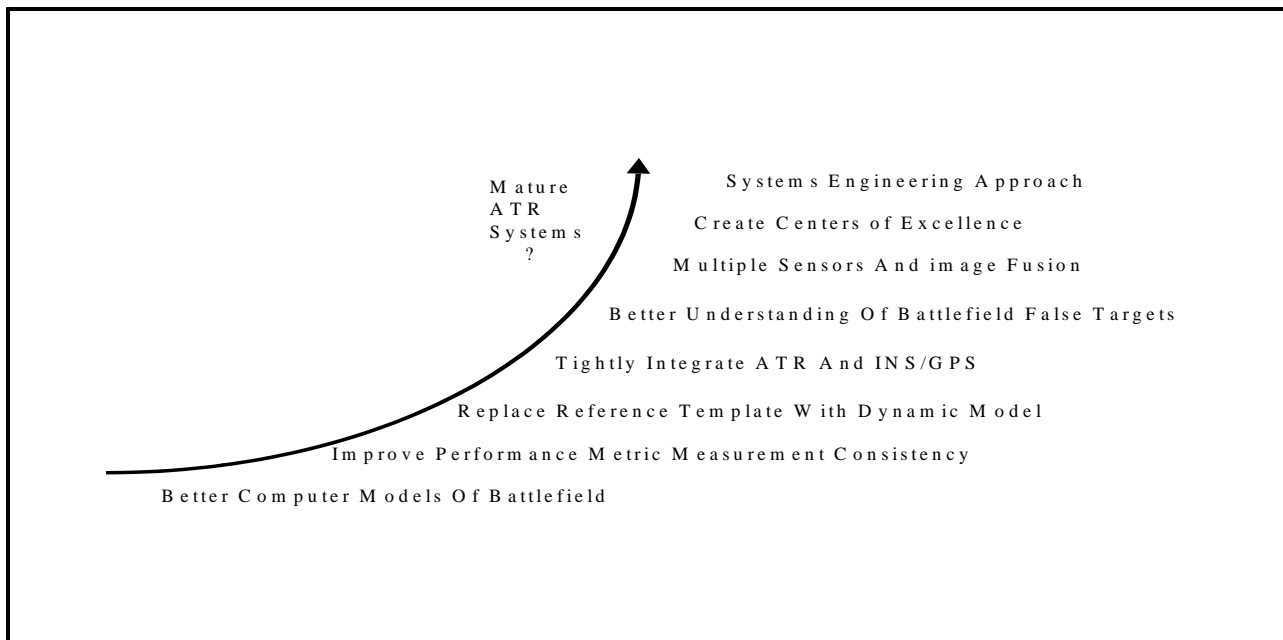

Figure 17. ATR Technology Trend



## REPORT DOCUMENTATION PAGE

<b>1. Recipient's Reference</b>	<b>2. Originator's References</b> RTO-EN-018 AC/323(SCI-087 bis)TP/37	<b>3. Further Reference</b> ISBN 92-837-1070-3	<b>4. Security Classification of Document</b> UNCLASSIFIED/ UNLIMITED
<b>5. Originator</b> Research and Technology Organization North Atlantic Treaty Organization BP 25, 7 rue Ancelle, F-92201 Neuilly-sur-Seine Cedex, France			
<b>6. Title</b> Technologies for Future Precision Strike Missile Systems			
<b>7. Presented at/sponsored by</b> the Systems Concepts and Integration Panel (SCI) and the Consultant and Exchange Programme of RTO presented on 18-19 June 2001 in Tbilisi, Georgia, on 21-22 June 2001 in Bucharest, Romania, on 25-26 June 2001 in Madrid, Spain, and on 28-29 June 2001 in Stockholm, Sweden.			
<b>8. Author(s)/Editor(s)</b> Multiple			<b>9. Date</b> July 2001
<b>10. Author's/Editor's Address</b> Multiple			<b>11. Pages</b> 148
<b>12. Distribution Statement</b> There are no restrictions on the distribution of this document. Information about the availability of this and other RTO unclassified publications is given on the back cover.			
<b>13. Keywords/Descriptors</b>			
Precision guided munitions	Global positioning system	Submunitions	
Missiles	Inertial navigation	Computerized simulation	
Mission profiles	Homing devices	Integrated systems	
Military planning	Millimeter waves	Target recognition	
Data links	Synthetic aperture radar	Precision strike	
Aerodynamics	Design	Technology assessment	
Missile airframes	Warheads	Infrared seekers	
Missile guidance	Kinetic energy	Smart weapons	
Missile control			
<b>14. Abstract</b>			
<p>This lecture series addressed recent advances in the state-of-the-art for precision strike missile systems. Emerging technologies that were addressed in the lecture series included:</p> <ul style="list-style-type: none"> <li>• <b>Mission planning technology.</b> Assessments included off-board sensor integration, near-real-time mission planning, flight altitude, terrain following and missile data links for in-flight targeting.</li> <li>• <b>Missile aeromechanics technology.</b> Assessments included hypersonic airframes, low cost/high temperature structure, and ramjet propulsion.</li> <li>• <b>Guidance &amp; control technology.</b> An overview of existing guidance and control was given. Assessments included precision guidance and optimal guidance laws.</li> <li>• <b>Missile GPS/INS sensor technology.</b> Assessments included low cost INS and GPS/INS integration.</li> <li>• <b>Missile design technology.</b> An overview of the missile design process was given. Assessments included computer programs and electronic spreadsheets for conceptual design and missile design criteria.</li> <li>• <b>Seeker technology.</b> Assessments included active and passive imaging infrared and radar seekers.</li> <li>• <b>Missile/aircraft integration technology.</b> Assessments included high firepower weapon concepts, reduced observables, and insensitive munitions.</li> <li>• <b>Simulation/validation technology.</b> Assessments included hardware-in-the-loop and design validation.</li> </ul>			

**This page has been deliberately left blank**



**Page intentionnellement blanche**



## RESEARCH AND TECHNOLOGY ORGANIZATION

BP 25 • 7 RUE ANCELLE

F-92201 NEUILLY-SUR-SEINE CEDEX • FRANCE

Télécopie 0(1)55.61.22.99 • E-mail mailbox@rta.nato.int

## DIFFUSION DES PUBLICATIONS

RTO NON CLASSIFIEES

L'Organisation pour la recherche et la technologie de l'OTAN (RTO), détient un stock limité de certaines de ses publications récentes, ainsi que de celles de l'ancien AGARD (Groupe consultatif pour la recherche et les réalisations aérospatiales de l'OTAN). Celles-ci pourront éventuellement être obtenues sous forme de copie papier. Pour de plus amples renseignements concernant l'achat de ces ouvrages, adressez-vous par lettre ou par télécopie à l'adresse indiquée ci-dessus. Veuillez ne pas téléphoner.

Des exemplaires supplémentaires peuvent parfois être obtenus auprès des centres nationaux de distribution indiqués ci-dessous. Si vous souhaitez recevoir toutes les publications de la RTO, ou simplement celles qui concernent certains Panels, vous pouvez demander d'être inclus sur la liste d'envoi de l'un de ces centres.

Les publications de la RTO et de l'AGARD sont en vente auprès des agences de vente indiquées ci-dessous, sous forme de photocopie ou de microfiche. Certains originaux peuvent également être obtenus auprès de CASI.

## CENTRES DE DIFFUSION NATIONAUX

**ALLEMAGNE**

Streitkräfteamt / Abteilung III  
Fachinformationszentrum der  
Bundeswehr, (FIZBw)  
Friedrich-Ebert-Allee 34  
D-53113 Bonn

**BELGIQUE**

Coordinateur RTO - VSL/RTO  
Etat-Major de la Force Aérienne  
Quartier Reine Elisabeth  
Rue d'Evère, B-1140 Bruxelles

**CANADA**

Services d'information scientifique  
pour la défense (SISD)  
R et D pour la défense Canada  
Ministère de la Défense nationale  
Ottawa, Ontario K1A 0K2

**DANEMARK**

Danish Defence Research Establishment  
Ryvangs Allé 1, P.O. Box 2715  
DK-2100 Copenhagen Ø

**ESPAGNE**

INTA (RTO/AGARD Publications)  
Carretera de Torrejón a Ajalvir, Pk.4  
28850 Torrejón de Ardoz - Madrid

**ETATS-UNIS**

NASA Center for AeroSpace  
Information (CASI)  
Parkway Center  
7121 Standard Drive  
Hanover, MD 21076-1320

**FRANCE**

O.N.E.R.A. (ISP)  
29, Avenue de la Division Leclerc  
BP 72, 92322 Châtillon Cedex

**GRECE (Correspondant)**

Hellenic Ministry of National  
Defence  
Defence Industry Research &  
Technology General Directorate  
Technological R&D Directorate  
D.Soutsou 40, GR-11521, Athens

**HONGRIE**

Department for Scientific  
Analysis  
Institute of Military Technology  
Ministry of Defence  
H-1525 Budapest P O Box 26

**ISLANDE**

Director of Aviation  
c/o Flugrad  
Reykjavik

**ITALIE**

Centro di Documentazione  
Tecnico-Scientifica della Difesa  
Via XX Settembre 123a  
00187 Roma

**LUXEMBOURG**

Voir Belgique

**NORVEGE**

Norwegian Defence Research  
Establishment  
Attn: Biblioteket  
P.O. Box 25, NO-2007 Kjeller

**PAYS-BAS**

NDRCC  
DGM/DWOO  
P.O. Box 20701  
2500 ES Den Haag

**POLOGNE**

Chief of International Cooperation  
Division  
Research & Development Department  
218 Niepodleglosci Av.  
00-911 Warsaw

**PORTUGAL**

Estado Maior da Força Aérea  
SDFA - Centro de Documentação  
Alfragide  
P-2720 Amadora

**REPUBLIQUE TCHEQUE**

Distribuční a informační středisko R&T  
VTÚL a PVO Praha  
Mladoboleslavská ul.  
197 06 Praha 9-Kbely AFB

**ROYAUME-UNI**

Defence Research Information Centre  
Kentigern House  
65 Brown Street  
Glasgow G2 8EX

**TURQUIE**

Millî Savunma Başkanlığı (MSB)  
ARGE Dairesi Başkanlığı (MSB)  
06650 Bakanlıklar - Ankara

## AGENCES DE VENTE

**NASA Center for AeroSpace**

**Information (CASI)**  
Parkway Center  
7121 Standard Drive  
Hanover, MD 21076-1320  
Etats-Unis

**The British Library Document**

**Supply Centre**  
Boston Spa, Wetherby  
West Yorkshire LS23 7BQ  
Royaume-Uni

**Canada Institute for Scientific and**

**Technical Information (CISTI)**  
National Research Council  
Document Delivery  
Montreal Road, Building M-55  
Ottawa K1A 0S2, Canada

Les demandes de documents RTO ou AGARD doivent comporter la dénomination "RTO" ou "AGARD" selon le cas, suivie du numéro de série (par exemple AGARD-AG-315). Des informations analogues, telles que le titre et la date de publication sont souhaitables. Des références bibliographiques complètes ainsi que des résumés des publications RTO et AGARD figurent dans les journaux suivants:

**Scientific and Technical Aerospace Reports (STAR)**

STAR peut être consulté en ligne au localisateur de ressources uniformes (URL) suivant:  
<http://www.sti.nasa.gov/Pubs/star/Star.html>

STAR est édité par CASI dans le cadre du programme NASA d'information scientifique et technique (STI)  
STI Program Office, MS 157A  
NASA Langley Research Center  
Hampton, Virginia 23681-0001  
Etats-Unis

**Government Reports Announcements & Index (GRA&I)**

publié par le National Technical Information Service  
Springfield  
Virginia 2216  
Etats-Unis  
(accessible également en mode interactif dans la base de données bibliographiques en ligne du NTIS, et sur CD-ROM)



Imprimé par St-Joseph Ottawa/Hull  
(Membre de la Corporation St-Joseph)

45, boul. Sacré-Cœur, Hull (Québec), Canada J8X 1C6



## RESEARCH AND TECHNOLOGY ORGANIZATION

BP 25 • 7 RUE ANCELLE

F-92201 NEUILLY-SUR-SEINE CEDEX • FRANCE

Telefax 0(1)55.61.22.99 • E-mail mailbox@rta.nato.int

## DISTRIBUTION OF UNCLASSIFIED

## RTO PUBLICATIONS

NATO's Research and Technology Organization (RTO) holds limited quantities of some of its recent publications and those of the former AGARD (Advisory Group for Aerospace Research & Development of NATO), and these may be available for purchase in hard copy form. For more information, write or send a telefax to the address given above. **Please do not telephone.**

Further copies are sometimes available from the National Distribution Centres listed below. If you wish to receive all RTO publications, or just those relating to one or more specific RTO Panels, they may be willing to include you (or your organisation) in their distribution.

RTO and AGARD publications may be purchased from the Sales Agencies listed below, in photocopy or microfiche form. Original copies of some publications may be available from CASI.

## NATIONAL DISTRIBUTION CENTRES

**BELGIUM**

Coordinateur RTO - VSL/RTO  
Etat-Major de la Force Aérienne  
Quartier Reine Elisabeth  
Rue d'Evère, B-1140 Bruxelles

**CANADA**

Defence Scientific Information  
Services (DSIS)  
Defence R&D Canada  
Department of National Defence  
Ottawa, Ontario K1A 0K2

**CZECH REPUBLIC**

Distribuční a informační středisko R&T  
VTÚL a PVO Praha  
Mladoboleslavská ul.  
197 06 Praha 9-Kbely AFB

**DENMARK**

Danish Defence Research  
Establishment  
Ryvangs Allé 1, P.O. Box 2715  
DK-2100 Copenhagen Ø

**FRANCE**

O.N.E.R.A. (ISP)  
29 Avenue de la Division Leclerc  
BP 72, 92322 Châtillon Cedex

**GERMANY**

Streitkräfteamt / Abteilung III  
Fachinformationszentrum der  
Bundeswehr, (FIZBw)  
Friedrich-Ebert-Allee 34  
D-53113 Bonn

**GREECE (Point of Contact)**

Hellenic Ministry of National  
Defence  
Defence Industry Research &  
Technology General Directorate  
Technological R&D Directorate  
D.Soutsou 40, GR-11521, Athens

**HUNGARY**

Department for Scientific  
Analysis  
Institute of Military Technology  
Ministry of Defence  
H-1525 Budapest P O Box 26

**ICELAND**

Director of Aviation  
c/o Flugrad  
Reykjavik

**ITALY**

Centro di Documentazione  
Tecnico-Scientifica della Difesa  
Via XX Settembre 123a  
00187 Roma

**LUXEMBOURG**

See Belgium

**NETHERLANDS**

NDRCC  
DGM/DWOO  
P.O. Box 20701  
2500 ES Den Haag

**NORWAY**

Norwegian Defence Research  
Establishment  
Attn: Biblioteket  
P.O. Box 25, NO-2007 Kjeller

**POLAND**

Chief of International Cooperation  
Division  
Research & Development  
Department  
218 Niepodleglosci Av.  
00-911 Warsaw

**PORTUGAL**

Estado Maior da Força Aérea  
SDFA - Centro de Documentação  
Alfragide  
P-2720 Amadora

**SPAIN**

INTA (RTO/AGARD Publications)  
Carretera de Torrejón a Ajalvir, Pk.4  
28850 Torrejón de Ardoz - Madrid

**TURKEY**

Millî Savunma Başkanlığı (MSB)  
ARGE Dairesi Başkanlığı (MSB)  
06650 Bakanlıklar - Ankara

**UNITED KINGDOM**

Defence Research Information  
Centre  
Kentigern House  
65 Brown Street  
Glasgow G2 8EX

**UNITED STATES**

NASA Center for AeroSpace  
Information (CASI)  
Parkway Center  
7121 Standard Drive  
Hanover, MD 21076-1320

## SALES AGENCIES

**NASA Center for AeroSpace  
Information (CASI)**

Parkway Center  
7121 Standard Drive  
Hanover, MD 21076-1320  
United States

**The British Library Document  
Supply Centre**

Boston Spa, Wetherby  
West Yorkshire LS23 7BQ  
United Kingdom

**Canada Institute for Scientific and  
Technical Information (CISTI)**

National Research Council  
Document Delivery  
Montreal Road, Building M-55  
Ottawa K1A 0S2, Canada

Requests for RTO or AGARD documents should include the word 'RTO' or 'AGARD', as appropriate, followed by the serial number (for example AGARD-AG-315). Collateral information such as title and publication date is desirable. Full bibliographical references and abstracts of RTO and AGARD publications are given in the following journals:

**Scientific and Technical Aerospace Reports (STAR)**

STAR is available on-line at the following uniform resource locator:

<http://www.sti.nasa.gov/Pubs/star/Star.html>

STAR is published by CASI for the NASA Scientific and Technical Information (STI) Program  
STI Program Office, MS 157A  
NASA Langley Research Center  
Hampton, Virginia 23681-0001  
United States

**Government Reports Announcements & Index (GRA&I)**

published by the National Technical Information Service  
Springfield  
Virginia 22161  
United States  
(also available online in the NTIS Bibliographic Database or on CD-ROM)



Printed by St. Joseph Ottawa/Hull  
(A St. Joseph Corporation Company)  
45 Sacré-Cœur Blvd., Hull (Québec), Canada J8X 1C6